



WORLDIA
SHAPING YOUR WORLD
WITH DIAMOND

Superhard Cutting Tools

PCD Insert/ PCBN Insert/ PCD, PCBN Grooving Solution

PCD Face Milling Cutter/ PCD Non-standard Tools



WWW.WORLDIA-TOOLS.COM

CONTENTS

PCD Turning Inserts

PCD Material Introduction	2
Cutting Direction Recommendation	5
Nomenclature	6
Specification of PCD and CVDD Inserts	8

PCBN Turning Inserts

Worldia PCBN Overview.....	20
PCBN Material Introduction	21
Application Case Studies and Worldia Recommendations	26
Coating Introduction	31
Wiper Introduction	32
Chip Breaker Introduction	33
Nomenclature	34
PCBN insert –Hardened Steel	36
PCBN insert–Cast Iron	68
PCBN insert–Powder Metallurgy	91
Technical Data	98
Precautions of How to Use Turning Tools	105

Indexable PCD and PCBN Milling Cutters

ManaNova Standard Program – Easy Choice – Fast Delivery	108
Worldia PCD and PCBN Indexable Milling Cutters – Product Selection	109
FMP–BE Indexable Milling Cutters	110
FMP–BE Shell Milling Cutters – Fine Pitch ISO	112
FMP–BE Shell Milling Cutters – Fine Pitch INCH	113
FMP–BE Shell Milling Cutters – Light Weight/ Coarse Pitch	114
FMP–BE Shank and Screw-on Milling Cutters	115
FMP–BE Disc Milling Cutters ISO	116
Customized FMP–BE Cutters	117
Worldia FMP–SD Indexable Milling Cutters	118
FMP–SD Shell Milling Cutters	120
Customized FMP–SD Cutters	121
Milling Adaptors BT / HSK	122
Milling Adaptors–Light Weight BT / HSK	123

Insert Nomenclature	124
BEHW PCD–tipped Milling Inserts for Light and Medium Applications	126
BEHW PCD–tipped Milling Inserts for Heavy Duty Applications	127
BEHW PCBN–tipped Milling Inserts for Face and Shoulder Milling Applications...128	
SDHN Full–Face PCBN Milling Inserts for Finish Face Milling Applications ...	129
PCD Grades and Application Recommendations	130
PCBN Grades and Application Recommendations	131
Application Case Studies and Worldia Recommendations	132
Assembly and Setting Instructions Worldia FMP–BE Indexable Milling Cutter ...	133
Assembly and Setting Instructions Worldia FMP–SD Indexable Milling Cutter ...	134
Worldia Services	138

PCD and PCBN Grooving Cutters

PCD/PCBN Material Introduction	140
Grooving Tools Nomenclature	142
Standard Grooving Inserts	143
Circlip Grooving Inserts	144
Cutting off Inserts	145
Groove Turning Toolholders	146
Customized Grooving Inserts	147
Application Cases	148

PCD Non-standard Tools

WORLDIA® Specialty Tools Introduction	150
Aluminium Alloy Cylinder Head	152
Clutch Housing	154
Gear Box/Oil Pan	156
Steering Gear	158
Brake Caliper	160
Throttle Valve	162
Steering Knuckles	166
Turbocharger housing	170
Aluminium Products	172
Scroll Plate	174
Helical milling cutter	176
Specialty cutters for composite materials	177
Worldia Services	192
Metric and Imperial Conversion Table	193

PCD Turning Inserts

Standard/Chip breaker/Wiper

N



Worldia PCD Grades Introduction

Standard/Chip breaker/Wiper

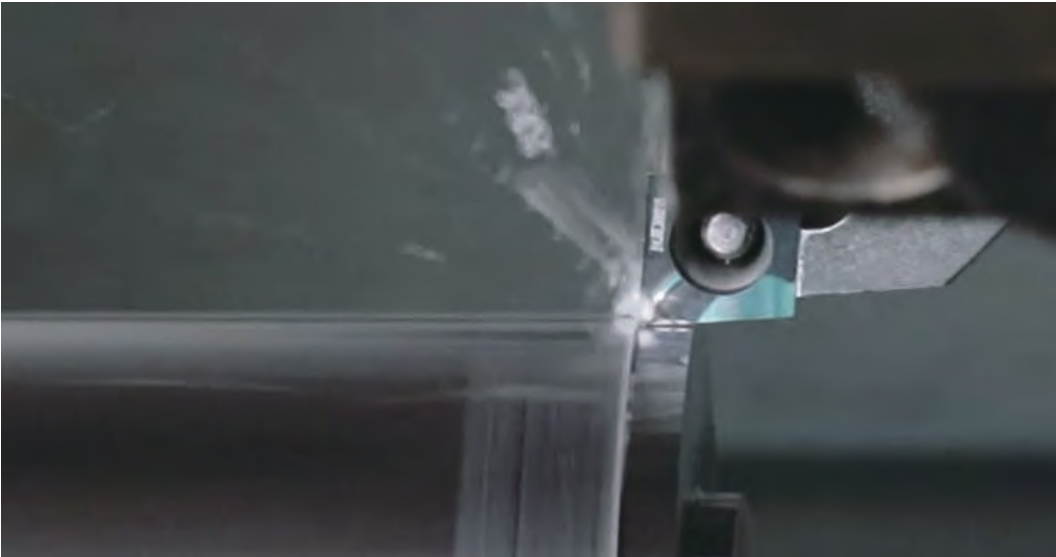

Introduction:

Worldia' portfolio comprise of a variety of different PCD and CVD materials that will be selected base on customer specific application requirements, according to grain size and features of material, Worldia provides you with four types of PCD grades:PD01E、 PD10E、 PD32E and CVDD. These grades are commonly used for non-ferrous machining applications, other successful applications include machining of wood、 MDF、 MMC、 silicon aluminium alloys、 carbide、 hard rubber、 graphite and so on.

This catalogue shows examples of Worldia' s capabilities and recommendations for application-specific made-to-order inserts.

For on-stock standard inserts, please refer to our MANANOVA -Easy Choice -Fast Delivery PCD catalogue.

PCD Material Introduction N

Application Recommendation

Material	Grade size(μm)	Feature	Application
PD01E	1	PD01E fine grain size PCD material(1μm) is suitable for mirror finishing applications. Its high impact resistance and high abrasive resistance are comparable to coarse grain size grade of PCD.	PD01E has excellent chip resistance is suitable for the roughing and interrupt cutting aluminium alloys. This grade is also commonly used for non-ferrous finishing applications. Other successful applications include machining of wood, MDF.
PD10E	10	PD10E is the universal grade in the market. It's the first choice for many applications where a good balance of toughness and wear resistance are required.	This grade is commonly used for non-ferrous finishing applications. Other successful applications include machining of wood, MDF. The machining of low-medium content silicon aluminium alloys, carbide, hard rubber, graphite and so on.
PD32E	2~30	PD32E has a unique combination of wear resistance, edge strength and edge quality. It contains a carefully selected mix of micron diamond (between 2 - 30 μm). The combination of these particle sizes and a specifically developed high pressure sintering process produces a structure with extreme abrasion resistance and good thermal stability.	Application areas include the machining of abrasive workpieces such as MMC, high silicon aluminium alloys as well as for the machining of carbide, hard rubber, graphite and other applications.
CVDD	—	CVDD is a pure carbon material without binder with extreme abrasion resistance and good thermal suitability. Due to its Perfect cutting edge suitable for applications where mirror finishes are required.	Application areas include the machining of abrasive workpieces such as MMC, high silicon aluminium alloys as well as for the machining of carbide, hard rubber, graphite and other applications.

Micro-Structure of PCD Materials

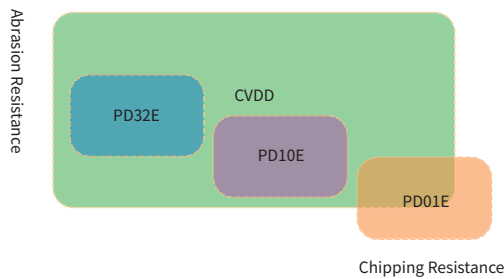

Differences in Abrasive-resistance Among Various Grade of PCD Materials

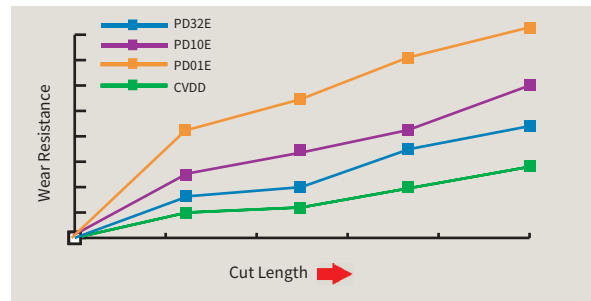

PCD Grain Size Affects Roughness of Workpiece's Surface

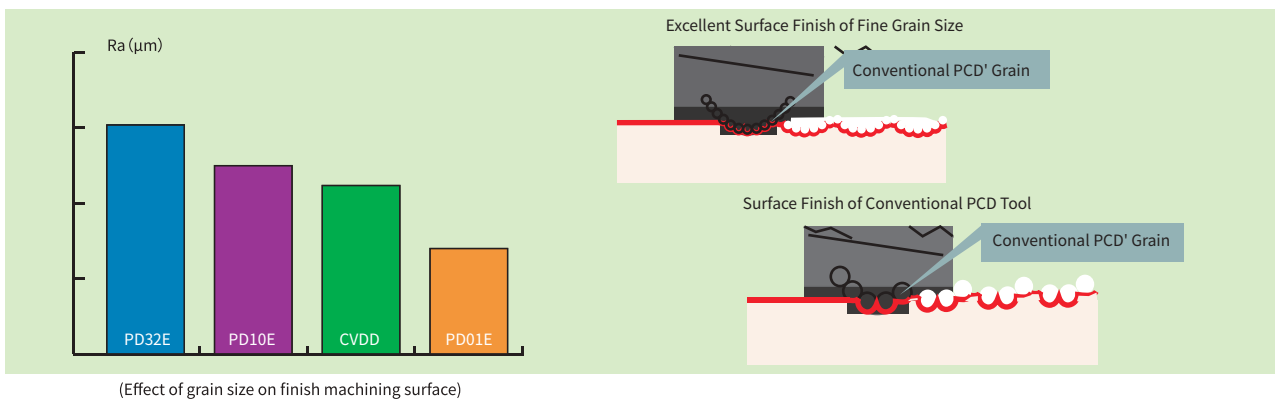

PCD Material Introduction N

PCD Insert with chip-breaker /Wiper

PCD Insert with chip-breaker(CBC1)

Excellent chip breaking in finishing machining

Scope of Application

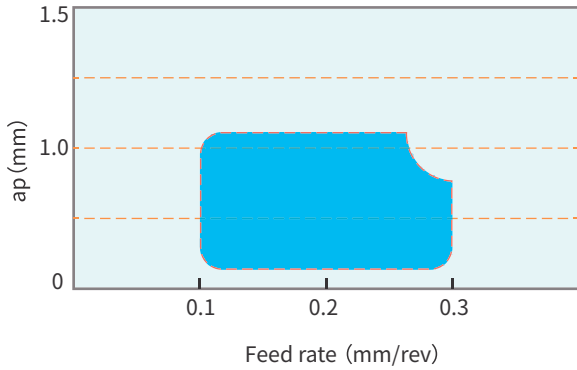

Material:A6061

Cutting conditions:Vc=400m/min f=0.1mm/rev ap=0.2mm

Insert type:CCGW09T308



Material:A6061

Cutting conditions:Vc=400m/min f=0.1mm/rev ap=0.5mm

Insert type:CCGW09T308



PCD Wiper Insert(WG)

Improve the quality of workpiece surface or processing efficiency

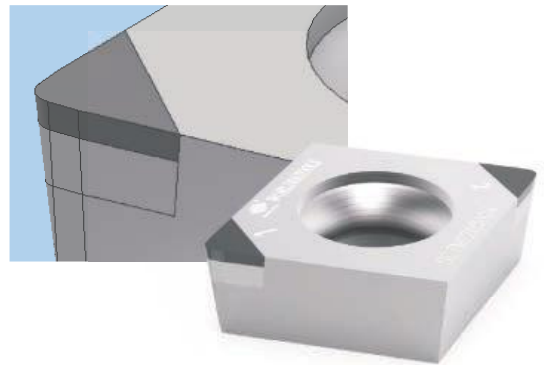

Effect of Wiper Insert

With the same R_t ,

Wiper inserts increase double feed rate($2xf_n$).

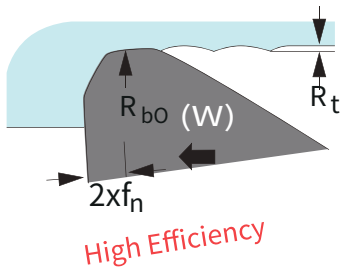

Under the same f_n ,

Wiper inserts improve the surface quality($\frac{R_t}{2}$).

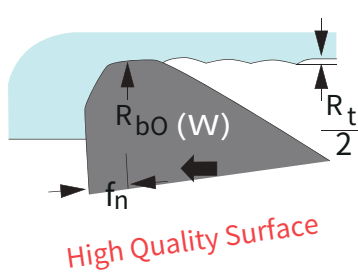

Standard corner radius

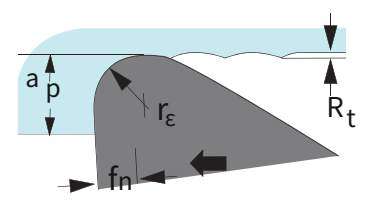

Cutting Direction Recommendation

Recommended cutting direction for turning no-ferrous with PCD tools

External machining

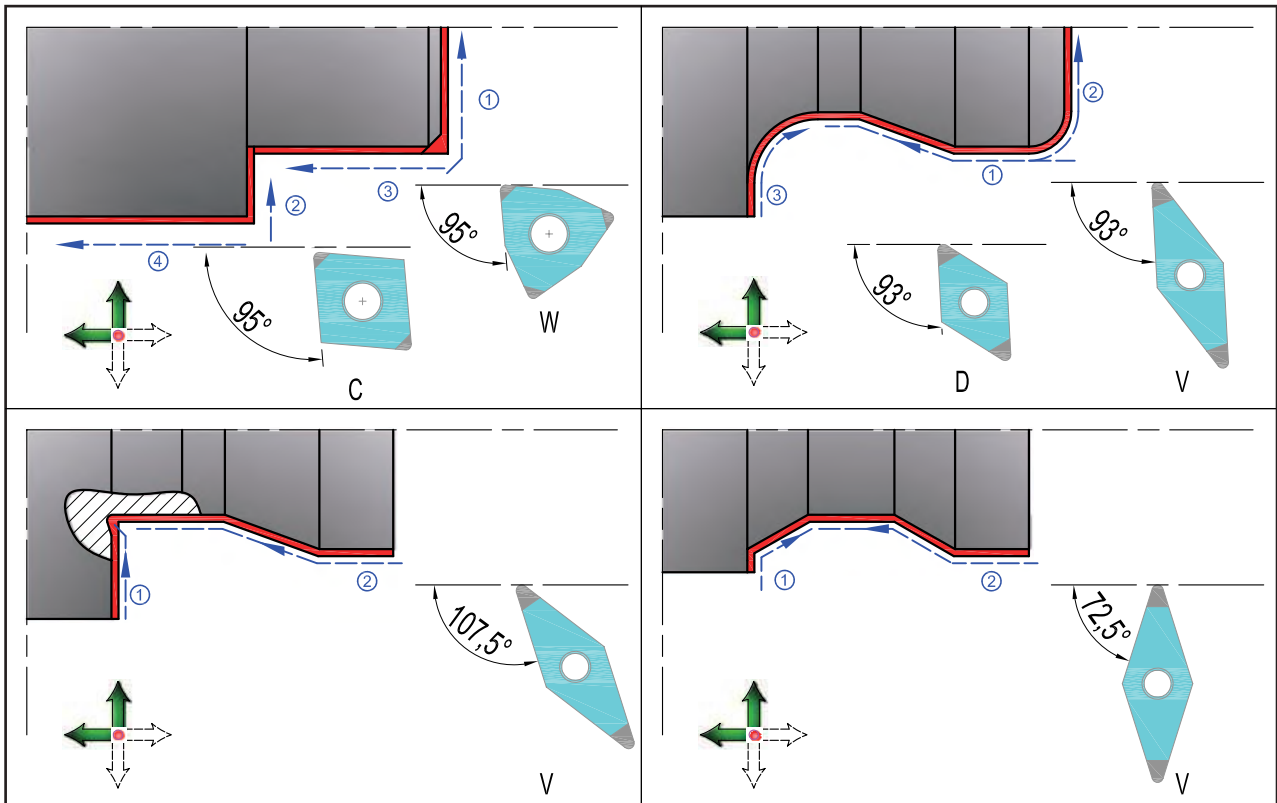

Internal machining

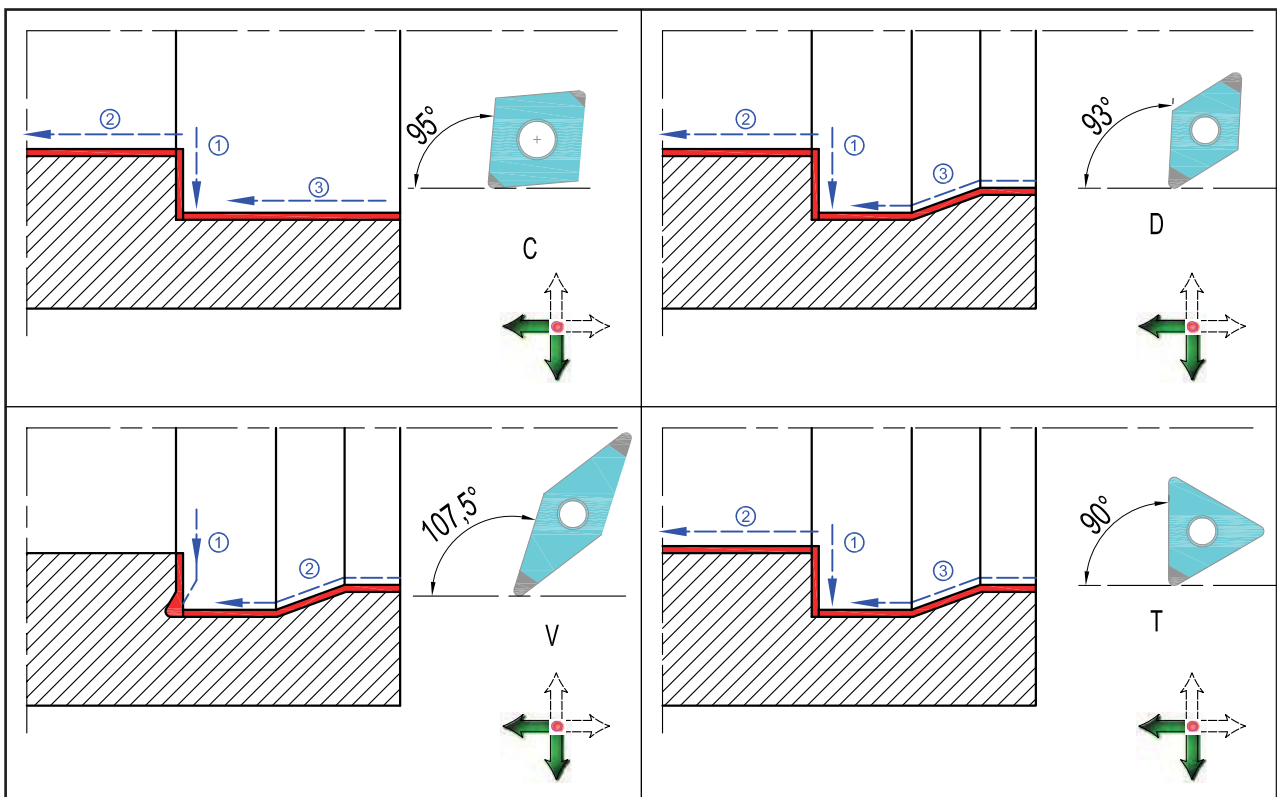

Nomenclature

Rule of PCD Insert Code

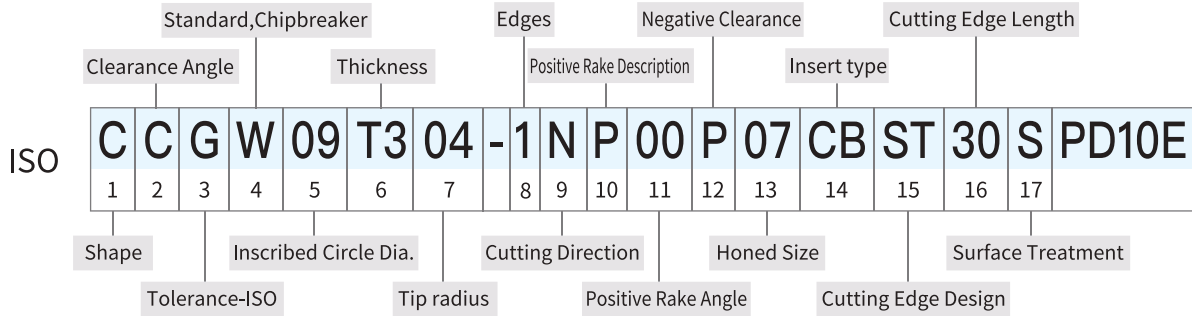

1. Shape		
	H	Hexagon
	O	Octagonal
	P	Pentagon
	R	Round
	S	Square
	T	Triangle
	C	Diamond
	D	80°
	E	55°
	M	75°
	V	86°
	W	35°
	L	Hexagon
	A	80°
	B	Rectangular
	K	90°
		Diamond
		85°
		82°
		55°

3. Tolerance-ISO							
Code	Tolerance			Code	inch		
	m	s	IC		m	ic	s
C	±0.013	±0.025	±0.025	C	±.0005	±.001	±.001
H	±0.013	±0.025	±0.013	H	±.0005	±.0005	±.001
E	±0.025	±0.025	±0.025	E	±.001	±.001	±.001
G	±0.025	±0.13	±0.025	G	±.001	±.001	±.005
K	±0.013	±0.025	±0.05-±0.13	K	±.0005	±.002-.005	±.001
M	±0.08-±0.18	±0.13	±0.05-±0.13	M	±.002-.005	±.002-.005	±.005
U	±0.13-±0.38	±0.13	±0.08-±0.25	U	±.005-.012	±.005-.010	±.005

2. Clearance Angle			
	A		E
	B		F
	C		G
	D		N
	P		O

5. Inscribed Circle Dia.							
ISO				ANSI			
Edge length (accoring insert shape)	Inscribed Circle Dia.			Code	IC Size		
C D R S T V W	mm				inch		
S4 04 03 03 06 - 02	3.97			(1.2)	5/32		
04 05 04 04 08 08 S3	4.76			(1.5)	3/16		
05 06 05 05 09 09 03	5.56			(1.8)	7/32		
- - 06 - - - - -	6			-	-		
06 07 06 06 11 11 04	6.35			2	1/4		
08 09 07 07 13 13 05	7.94			(2.5)	5/16		
- - 08 - - - - -	8			-	-		
09 11 09 09 16 16 06	9.525			3	3/8		
- - 10 - - - - -	10			-	-		
- - 12 - - - - -	12			-	-		
12 15 12 12 22 22 08	12.7			4	1/2		
16 19 15 15 27 27 10	15.875			5	5/8		
- - 16 - - - - -	16			-	-		
19 23 19 19 33 33 13	19.05			6	3/4		
- - 20 - - - - -	20			-	-		
22 27 22 22 38 38 15	22.225			7	7/8		
- - 25 - - - - -	25			-	-		
25 31 25 25 44 44 17	25.4			8	1		
32 38 31 31 54 54 21	31.75			10	1-1/4		
- - 32 - - - - -	32			-	-		

6. Thickness			
ISO		ANSI	
Code	Size	Code	Size
S	mm	S	inch
01	1.59	1	1/16
02	2.38	(1.5)	3/32
T2	2.78	-	-
03	3.18	2	1/8
T3	3.97	(2.5)	5/32
04	4.76	3	3/16
05	5.56	(3.5)	7/32
06	6.35	4	1/4
07	7.94	5	5/16
09	9.525	6	3/8

7. Tip radius			
ISO		ANSI	
Code	Size	Code	Size
Rε	mm	Rε	inch
00	sharp	00	.000
003	0.03	(0.1)	.001
01	0.1	(0.2)	.004
02	0.2	(0.5)	.008
04	0.4	1	1/64
08	0.8	2	1/32
12	1.2	3	3/64
16	1.6	4	1/16
20	2.0	5	5/64
24	2.4	6	3/32
28	2.8	7	7/64
32	3.2	8	1/8
M00	Round		circular



4. Standard, Chipbreaker			
	N		G
	R		W
	F		T
	A		Q
	M		U
		Others	X

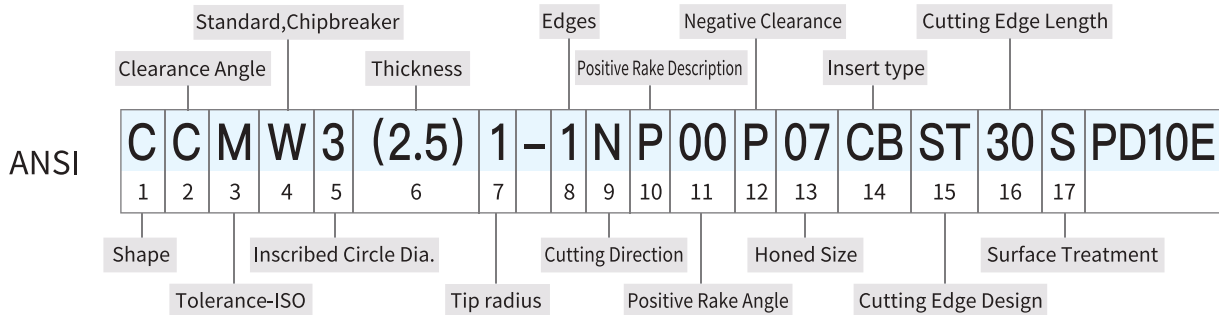

Nomenclature

Rule of PCD Insert Code





8. Edges							
Code	1	2	3	4	6	8	
Edges	一刃	二刃	三刃	四刃	六刃	八刃	





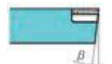
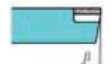

9. Cutting Direction			
Code	R	L	N
			

10. Positive Rake Description		
P		M
Positive Positive		Negative angle
		

11. Positive Rake Angle					
Code	α	00	03	05	10
Size	$^\circ$	0	3	5	10

12. Negative Clearance			
P		M	
Positive Clearance		Negative Clearance	
			

13. Honed Size						
Code	00	02	05	10	20	30

14. Insert type						
SF	SL	SS	CB	CS	SWW	SWU
Full Face	Solid Tipped Corner	Solid CBN	Standard Tipped Corners	Standard Full Edge	Solid Tipped Corners Type "W"	Solid Tipped Corners Type "U"
						

15. Cutting Edge Design				
ST	WG	WG00	CBC1	—
Nose Radius	Wiper	0°Wiper	C1 Chip Breaker	—

16. Cutting Edge Length					
Code	25	30	35	40	45
Nose Radius	2.8	3.0	3.5	4.0	4.5

17. Surface Treatment	
S	Uncoated

Standard PCD Turning Inserts

PCD Tipped for Non-ferrous

CC	80°Positive Screw-down
	Standard
	CC ◆◆ 0602 ◆◆

N				
Tips type	CB	CB	CB	SL
Cutting edge	CCGW—P00P07			
	CCGT—P05P07 /P10P07			
Grade	PD01E	PD10E	PD32E	CVDD

Shape	ISO	ANSI	Tips form and size		Tips	ic	φd	S	re	la
	CCGW060202-1N	CCGW2(1.5)(0.5)-1N		ST25S	1	6.35	2.8	2.38	0.2	2.5
	CCGW060204-1N	CCGW/T2(1.5)1-1N							0.4	
	CCGT060202-1N	CCGT2(1.5)(0.5)-1N							0.2	
	CCGT060204-1N	CCGT2(1.5)1-1N							0.4	

CC	80°Positive Screw-down
	Standard
	CC ◆◆ 09T3 ◆◆

N				
Tips type	CB	CB	CB	SL
Cutting edge	CCGW—P00P07			
	CCGT—P05P07 /P10P07			
Grade	PD01E	PD10E	PD32E	CVDD

Shape	ISO	ANSI	Tips form and size		Tips	ic	φd	S	re	la
	CCGW09T302-1N	CCGW3(2.5)(0.5)-1N		ST25S	1	9.525	4.4	3.97	0.2	2.5
	CCGW09T304-1N	CCGW3(2.5)1-1N							0.4	
	CCGW09T308-1N	CCGW3(2.5)2-1N							0.8	
	CCGT09T302-1N	CCGT3(2.5)(0.5)-1N							0.2	
	CCGT09T304-1N	CCGT3(2.5)1-1N							0.4	
	CCGT09T308-1N	CCGT3(2.5)2-1N							0.8	

CC	80°Positive Screw-down
	Standard
	CC ◆◆ 1204 ◆◆

N				
Tips type	CB	CB	CB	SL
Cutting edge	CCGW—P00P07			
	CCGT—P05P07 /P10P07			
Grade	PD01E	PD10E	PD32E	CVDD

Shape	ISO	ANSI	Tips form and size		Tips	ic	φd	S	re	la
	CCGW120402-1N	CCGW43(0.5)-1N		ST25S	1	9.525	4.4	3.97	0.2	2.5
	CCGW120404-1N	CCGW431-1N							0.4	
	CCGW120408-1N	CCGW432-1N							0.8	
	CCGT120402-1N	CCGT43(0.5)-1N							0.2	
	CCGT120404-1N	CCGT431-1N							0.4	
	CCGT120408-1N	CCGT432-1N							0.8	

Notes: Inserts with more than 1 tip on customer request

Standard PCD Turning Inserts

PCD Tipped for Non-ferrous

DC	55° Positive Screw-down
	Standard
	DC ◆◆◆ 0702 ◆◆◆

N				
Tips type	CB	CB	CB	SL
Cutting edge	DCGW—P00P07			
	DCGT—P05P07 /P10P07			
Grade	PD01E	PD10E	PD32E	CVDD

Shape	ISO	ANSI	Tips form and size		Tips	ic	φd	S	re	la
	DCGW070202-1N	DCGW2(1.5)(0.5)-1N		ST25S	1	6.35	2.8	2.38	0.2	2.5
	DCGW070204-1N	DCGW2(1.5)1-1N							0.4	
	DCGW070208-1N	DCGW2(1.5)2-1N							0.8	
	DCGT070202-1N	DCGT2(1.5)(0.5)-1N							0.2	
	DCGT070204-1N	DCGT2(1.5)1-1N							0.4	
	DCGT070208-1N	DCGT2(1.5)2-1N							0.8	

DC	55° Positive Screw-down
	Standard
	DC ◆◆◆ 11T3 ◆◆◆

N				
Tips type	CB	CB	CB	SL
Cutting edge	DCGW—P00P07			
	DCGT—P05P07 /P10P07			
Grade	PD01E	PD10E	PD32E	CVDD

Shape	ISO	ANSI	Tips form and size		Tips	ic	φd	S	re	la
	DCGW11T302-1N	DCGW3(2.5)(0.5)-1N		ST25S	1	9.525	4.4	3.97	0.2	2.5
	DCGW11T304-1N	DCGW3(2.5)1-1N							0.4	
	DCGW11T308-1N	DCGW3(2.5)2-1N							0.8	
	DCGT11T302-1N	DCGT3(2.5)(0.5)-1N							0.2	
	DCGT11T304-1N	DCGT3(2.5)1-1N							0.4	
	DCGT11T308-1N	DCGT3(2.5)2-1N							0.8	

Notes: Inserts with more than 1 tip on customer request

Standard PCD Turning Inserts

PCD Tipped for Non-ferrous

TC	60°Positive Screw-down
	Standard
	TC ◆◆◆0802 ◆◆◆

N				
Tips type	CB	CB	CB	SL
Cutting edge	TCGW—P00P07			
	TCGT—P05P07 /P10P07			
Grade	PD01E	PD10E	PD32E	CVDD

Shape	ISO	ANSI	Tips form and size		Tips	ic	φd	S	rε	la
	TCGW080202-1N	TCGW(1.5)(1.5)(0.5)-1N		ST25S	1	4.76	2.4	2.38	0.2	2.5
	TCGW080204-1N	TCGW(1.5)(1.5)1-1N							0.4	
	TCGW080208-1N	TCGW(1.5)(1.5)2-1N							0.8	
	TCGT080202-1N	TCGT(1.5)(1.5)(0.5)-1N							0.2	
	TCGT080204-1N	TCGT(1.5)(1.5)1-1N							0.4	
	TCGT080208-1N	TCGT(1.5)(1.5)2-1N							0.8	

TC	60°Positive Screw-down
	Standard
	TC ◆◆◆1103 ◆◆◆

N				
Tips type	CB	CB	CB	SL
Cutting edge	TCGW—P00P07			
	TCGT—P05P07 /P10P07			
Grade	PD01E	PD10E	PD32E	CVDD

Shape	ISO	ANSI	Tips form and size		Tips	ic	φd	S	rε	la
	TCGW110302-1N	TCGW22(0.5)-1N		ST25S	1	6.35	2.8	3.18	0.2	2.5
	TCGW110304-1N	TCGW221-1N							0.4	
	TCGW110308-1N	TCGW222-1N							0.8	
	TCGT110302-1N	TCGT22(0.5)-1N							0.2	
	TCGT110304-1N	TCGT221-1N							0.4	
	TCGT110308-1N	TCGT222-1N							0.8	

TC	60°Positive Screw-down
	Standard
	TC ◆◆◆1604 ◆◆◆

N				
Tips type	CB	CB	CB	SL
Cutting edge	TCGW—P00P07			
	TCGT—P05P07 /P10P07			
Grade	PD01E	PD10E	PD32E	CVDD

Shape	ISO	ANSI	Tips form and size		Tips	ic	φd	S	rε	la
	TCGW160402-1N	TCGW33(0.5)-1N		ST25S	1	9.525	4.4	4.76	0.2	2.5
	TCGW160404-1N	TCGW331-1N							0.4	
	TCGW160408-1N	TCGW332-1N							0.8	
	TCGT160402-1N	TCGT33(0.5)-1N							0.2	
	TCGT160404-1N	TCGT331-1N							0.4	
	TCGT160408-1N	TCGT332-1N							0.8	

Notes: Inserts with more than 1 tip on customer request

Standard PCD Turning Inserts

PCD Tipped for Non-ferrous

TP	60°Positive Screw-down
	Standard
	TP◆◆0802◆◆

N				
Tips type	CB	CB	CB	SL
Cutting edge	TPGW—P00P11			
	TPGT—P05P11 /P10P11			
Grade	PD01E	PD10E	PD32E	CVDD

Shape	ISO	ANSI	Tips form and size		Tips	ic	φd	S	re	la
	TPGW080202-1N	TPGW(1.5)(1.5)(0.5)-1N		ST25S	1	4.76	2.4	2.38	0.2	2.5
	TPGW080204-1N	TPGW(1.5)(1.5)1-1N							0.4	
	TPGW080208-1N	TPGW(1.5)(1.5)2-1N							0.8	
	TPGT080202-1N	TPGT(1.5)(1.5)(0.5)-1N							0.2	
	TPGT080204-1N	TPGT(1.5)(1.5)1-1N							0.4	
	TPGT080208-1N	TPGT(1.5)(1.5)2-1N							0.8	

TP	60°Positive Screw-down
	Standard
	TP◆◆1103◆◆

N				
Tips type	CB	CB	CB	SL
Cutting edge	TPGW—P00P11			
	TPGT—P05P11 /P10P11			
Grade	PD01E	PD10E	PD32E	CVDD

Shape	ISO	ANSI	Tips form and size		Tips	ic	φd	S	re	la
	TPGW110302-1N	TPGW22(0.5)-1N		ST25S	1	6.35	3.3	3.18	0.2	2.5
	TPGW110304-1N	TPGW221-1N							0.4	
	TPGW110308-1N	TPGW222-1N							0.8	
	TPGT110302-1N	TPGT22(0.5)-1N							0.2	
	TPGT110304-1N	TPGT221-1N							0.4	
	TPGT110308-1N	TPGT222-1N							0.8	

TP	60°Positive Screw-down
	Standard
	TP◆◆1603◆◆

N				
Tips type	CB	CB	CB	SL
Cutting edge	TPGW—P00P11			
	TPGT—P05P11 /P10P11			
Grade	PD01E	PD10E	PD32E	CVDD

Shape	ISO	ANSI	Tips form and size		Tips	ic	φd	S	re	la
	TPGW160302-1N	TPGW32(0.5)-1N		ST25S	1	6.35	3.3	3.18	0.2	2.5
	TPGW160304-1N	TPGW321-1N							0.4	
	TPGW160308-1N	TPGW322-1N							0.8	
	TPGT160302-1N	TPGT32(0.5)-1N							0.2	
	TPGT160304-1N	TPGT321-1N							0.4	
	TPGT160308-1N	TPGT322-1N							0.8	

Notes: Inserts with more than 1 tip on customer request

Standard PCD Turning Inserts

PCD Tipped for Non-ferrous

TP	60°Positive Screw-down
	Standard
	TP◆◆1604◆◆

N				
Tips type	CB	CB	CB	SL
Cutting edge	TPGW—P00P11			
	TPGT—P05P11 /P10P11			
Grade	PD01E	PD10E	PD32E	CVDD

Shape	ISO	ANSI	Tips form and size		Tips	ic	φd	S	rε	la
	TPGW160402-1N	TPGW33(0.5)-1N		ST25S	1	6.35	3.3	4.76	0.2	2.5
	TPGW160404-1N	TPGW331-1N							0.4	
	TPGW160408-1N	TPGW332-1N							0.8	
	TPGT160402-1N	TPGT33(0.5)-1N							0.2	
	TPGT160404-1N	TPGT331-1N							0.4	
	TPGT160408-1N	TPGT332-1N							0.8	

VB	35°Positive Screw-down
	Standard
	VB◆◆1103◆◆

N				
Tips type	CB	CB	CB	SL
Cutting edge	VBGW—P00P05			
	VBGT—P05P05 /P10P05			
Grade	PD01E	PD10E	PD32E	CVDD

Shape	ISO	ANSI	Tips form and size		Tips	ic	φd	S	rε	la
	VBGW110302-1N	VBGW22(0.5)-1N		ST30S	1	6.35	2.8	3.18	0.2	3.0
	VBGW110304-1N	VBGW221-1N							0.4	
	VBGW110308-1N	VBGW222-1N							0.8	
	VBGT110302-1N	VBGT22(0.5)-1N							0.2	
	VBGT110304-1N	VBGT221-1N							0.4	
	VBGT110308-1N	VBGT222-1N							0.8	

VB	35°Positive Screw-down
	Standard
	VB◆◆1604◆◆

N				
Tips type	CB	CB	CB	SL
Cutting edge	VBGW—P00P05			
	VBGT—P05P05 /P10P05			
Grade	PD01E	PD10E	PD32E	CVDD

Shape	ISO	ANSI	Tips form and size		Tips	ic	φd	S	rε	la
	VBGW160402-1N	VBGW33(0.5)-1N		ST30S	1	9.525	3.3	4.76	0.2	3.0
	VBGW160404-1N	VBGW331-1N							0.4	
	VBGW160408-1N	VBGW332-1N							0.8	
	VBGT160402-1N	VBGT33(0.5)-1N							0.2	
	VBGT160404-1N	VBGT331-1N							0.4	
	VBGT160408-1N	VBGT332-1N							0.8	

Notes: Inserts with more than 1 tip on customer request

Standard PCD Turning Inserts

PCD Tipped for Non-ferrous

VC	35° Positive Screw-down
	Standard
	VC◆◆1103◆◆

N				
Tips type	CB	CB	CB	SL
Cutting edge	VCGW—P00P07			
	VCGT—P05P07 / P10P07			
Grade	PD01E	PD10E	PD32E	CVDD

Shape	ISO	ANSI	Tips form and size		Tips	ic	φd	S	re	la
	VCGW110302-1N	VCGW22(0.5)-1N		ST30S	1	6.35	2.8	3.18	0.2	3.0
	VCGW110304-1N	VCGW221-1N							0.4	
	VCGW110308-1N	VCGW222-1N							0.8	
	VCGT110302-1N	VCGT22(0.5)-1N							0.2	
	VCGT110304-1N	VCGT221-1N							0.4	
	VCGT110308-1N	VCGT222-1N							0.8	

VC	35° Positive Screw-down
	Standard
	VC◆◆1604◆◆

N				
Tips type	CB	CB	CB	SL
Cutting edge	VCGW—P00P07			
	VCGT—P05P07 / P10P07			
Grade	PD01E	PD10E	PD32E	CVDD

Shape	ISO	ANSI	Tips form and size		Tips	ic	φd	S	re	la
	VCGW160402-1N	VCGW33(0.5)-1N		ST30S	1	9.525	4.4	4.76	0.2	3.0
	VCGW160404-1N	VCGW331-1N							0.4	
	VCGW160408-1N	VCGW332-1N							0.8	
	VCGT160402-1N	VCGT33(0.5)-1N							0.2	
	VCGT160404-1N	VCGT331-1N							0.4	
	VCGT160408-1N	VCGT332-1N							0.8	

Notes: Inserts with more than 1 tip on customer request

Standard PCD Turning Inserts

PCD Tipped for Non-ferrous

CN	80° Negative Screw-down
	Standard
	CN ◆◆ 1204 ◆◆

N				
Tips type	CB	CB	CB	SL
Cutting edge	CNGA—P00P00			
	CNGM—P10P00			
Grade	PD01E	PD10E	PD32E	CVDD

Shape	ISO	ANSI	Tips form and size		Tips	ic	φd	S	rε	la
	CNGA120402-1N	CNGA43(0.5)-1N		ST25S	1	12.7	5.16	4.76	0.2	2.5
	CNGA120404-1N	CNGA431-1N							0.4	
	CNGA120408-1N	CNGA432-1N							0.8	
	CNGM120402-1N	CNGM43(0.5)-1N							0.2	
	CNGM120404-1N	CNGM431-1N							0.4	
	CNGM120408-1N	CNGM432-1N							0.8	

DN	55° Negative Screw-down
	Standard
	DN ◆◆ 1504 ◆◆

N				
Tips type	CB	CB	CB	SL
Cutting edge	DNGA—P00P00			
	DNGM—P10P00			
Grade	PD01E	PD10E	PD32E	CVDD

Shape	ISO	ANSI	Tips form and size		Tips	ic	φd	S	rε	la
	DNGA150402-1N	DNGA43(0.5)-1N		ST25S	1	12.7	5.16	4.76	0.2	2.5
	DNGA150404-1N	DNGA431-1N							0.4	
	DNGA150408-1N	DNGA432-1N							0.8	
	DNGM150402-1N	DNGM43(0.5)-1N							0.2	
	DNGM150404-1N	DNGM431-1N							0.4	
	DNGM150408-1N	DNGM432-1N							0.8	

TN	60° Negative Screw-down
	Standard
	TN ◆◆ 1604 ◆◆

N				
Tips type	CB	CB	CB	SL
Cutting edge	TNGA—P00P00			
	TNGM—P10P00			
Grade	PD01E	PD10E	PD32E	CVDD

Shape	ISO	ANSI	Tips form and size		Tips	ic	φd	S	rε	la
	TNGA160402-1N	TNGA33(0.5)-1N		ST30S	1	9.525	3.81	4.76	0.2	2.5
	TNGA160404-1N	TNGA331-1N							0.4	
	TNGA160408-1N	TNGA332-1N							0.8	
	TNGM160402-1N	TNGM33(0.5)-1N							0.2	
	TNGM160404-1N	TNGM331-1N							0.4	
	TNGM160408-1N	TNGM332-1N							0.8	

Notes: Inserts with more than 1 tip on customer request

Standard PCD Turning Inserts

PCD Tipped for Non-ferrous

VN	35° Negative Screw-down
	Standard
	VN ◆◆ 1604 ◆◆

N				
Tips type	CB	CB	CB	SL
Cutting edge	VNGA—P00P00			
	VNGM—P10P00			
Grade	PD01E	PD10E	PD32E	CVDD

Shape	ISO	ANSI	Tips form and size		Tips	ic	φd	S	re	la
	VNGA160402-1N	VNGA33(0.5)-1N		ST30S	1	9.525	3.81	4.76	0.2	3.0
	VNGA160404-1N	VNGA331-1N							0.4	
	VNGA160408-1N	VNGA332-1N							0.8	
	VNGM160402-1N	VNGM33(0.5)-1N							0.2	
	VNGM160404-1N	VNGM331-1N							0.4	
	VNGM160408-1N	VNGM332-1N							0.8	

Notes: Inserts with more than 1 tip on customer request

Chip-breaker PCD Turning Inserts

PCD Tipped for Non-ferrous

CC 80°Positive Screw-down
Chip-breaker
 CC◆◆0602◆◆

N				
Tips type	CB	CB	CB	SL
Cutting edge	P00P07			
Grade	PD01E	PD10E	PD32E	CVDD

Shape	ISO	ANSI	Tips form and size		Tips	ic	φd	S	rε	la
	CCGT060202-1N	CCGT2(1.5)(0.5)-1N		CBC125S	1	6.35	2.8	2.38	0.2	2.5
	CCGT060204-1N	CCGT2(1.5)1-1N							0.4	
	CCGT09T302-1N	CCGT3(2.5)(0.5)-1N							0.2	
	CCGT09T304-1N	CCGT3(2.5)1-1N							0.4	
	CCGT09T308-1N	CCGT3(2.5)2-1N							0.8	

DC 55°Positive Screw-down
Chip-breaker
 DC◆◆0702/11T3◆◆

N				
Tips type	CB	CB	CB	SL
Cutting edge	P00P07			
Grade	PD01E	PD10E	PD32E	CVDD

Shape	ISO	ANSI	Tips form and size		Tips	ic	φd	S	rε	la
	DCGT070202-1N	DCGT2(1.5)(0.5)-1N		CBC125S	1	6.35	2.8	2.38	0.2	2.5
	DCGT070204-1N	DCGT2(1.5)1-1N							0.4	
	DCGT11T302-1N	DCGT3(2.5)(0.5)-1N							0.2	
	DCGT11T304-1N	DCGT3(2.5)1-1N							0.4	
	DCGT11T308-1N	DCGT3(2.5)2-1N							0.8	

TC 60°Positive Screw-down
Chip-breaker
 TC◆◆0802/1103/1604◆◆

N				
Tips type	CB	CB	CB	SL
Cutting edge	P00P07			
Grade	PD01E	PD10E	PD32E	CVDD

Shape	ISO	ANSI	Tips form and size		Tips	ic	φd	S	rε	la
	TCGT080202-1N	TCGT (1.5) (1.5)(0.5)-1N		CBC125S	1	4.76	2.4	2.38	0.2	2.5
	TCGT080204-1N	TCGT (1.5) (1.5)1-1N							0.4	
	TCGT110302-1N	TCGT22(0.5)-1N							0.2	
	TCGT110304-1N	TCGT221-1N							0.4	
	TCGT160402-1N	TCGT33(0.5)-1N							0.2	
	TCGT160404-1N	TCGT331-1N							0.4	
	TCGT160408-1N	TCGT332-1N							0.8	

Notes: Inserts with more than 1 tip on customer request

Chip-breaker PCD Turning Inserts

PCD Tipped for Non-ferrous

TP	60°Positive Screw-down
	Chip-breaker
	TP◆◆0802/1103/1604◆◆

N				
Tips type	CB	CB	CB	SL
Cutting edge	P00P07			
Grade	PD01E	PD10E	PD32E	CVDD

Shape	ISO	ANSI	Tips form and size		Tips	ic	φd	S	re	la
	TPGT080202-1N	TPGT (1.5) (1.5)(0.5)-1N		CBC125S	1	4.76	2.4	2.38	0.2	2.5
	TPGT080204-1N	TPGT (1.5) (1.5)1-1N							0.4	
	TPGT110302-1N	TPGT22(0.5)-1N				6.35	2.8	3.18	0.2	
	TPGT110304-1N	TPGT221-1N							0.4	
	TPGT160402-1N	TPGT33(0.5)-1N				9.525	4.4	4.76	0.2	
	TPGT160404-1N	TPGT331-1N							0.4	
	TPGT160408-1N	TPGT332-1N							0.8	

VC	35°Positive Screw-down
	Chip-breaker
	VC◆◆0602/09T3◆◆

N				
Tips type	CB	CB	CB	SL
Cutting edge	P00P07			
Grade	PD01E	PD10E	PD32E	CVDD

Shape	ISO	ANSI	Tips form and size		Tips	ic	φd	S	re	la
	VCGT110302-1N	VCGT22(0.5)-1N		CBC125S	1	6.35	3.3	3.18	0.2	2.5
	VCGT110304-1N	VCGT221-1N							0.4	
	VCGT160402-1N	VCGT33(0.5)-1N				9.525	4.4	4.76	0.2	
	VCGT160404-1N	VCGT331-1N							0.4	
	VCGT160408-1N	VCGT332-1N							0.8	

Notes: Inserts with more than 1 tip on customer request

Chip-breaker PCD Turning Inserts

PCD Tipped for Non-ferrous

CC	80°Positive Screw-down
	Wiper
	CC◆◆0602◆◆

N				
Tips type	CB	CB	CB	SL
Cutting edge	P00P00			
Grade	PD01E	PD10E	PD32E	CVDD

Shape	ISO	ANSI	Tips form and size		Tips	ic	φd	S	la	
									re	la
	CCGW060202-1N	CCGW2(1.5)(0.5)-1N		WG25S	1	6.35	2.8	2.38	0.2	2.5
	CCGW060204-1N	CCGW2(1.5)1-1N							0.4	
	CCGW09T302-1N	CCGW3(2.5)(0.5)-1N							0.2	
	CCGW09T304-1N	CCGW3(2.5)1-1N							0.4	
	CCGW09T308-1N	CCGW3(2.5)2-1N							0.8	
	CCGW120402-1N	CCGW43(0.5)-1N							0.2	
	CCGW120404-1N	CCGW431-1N							0.4	
	CCGW120408-1N	CCGW432-1N							0.8	

CN	80°Negative Screw-down
	Wiper
	CN◆◆1204◆◆

N				
Tips type	CB	CB	CB	SL
Cutting edge	P00P00			
Grade	PD01E	PD10E	PD32E	CVDD

Shape	ISO	ANSI	Tips form and size		Tips	ic	φd	S	la	
									re	la
	CNGA120402-1N	CNGA43(0.5)-1N		WG25S	1	12.7	5.16	4.76	0.2	2.5
	CNGA120404-1N	CNGA431-1N							0.4	
	CNGA120408-1N	CNGA432-1N							0.8	

Notes: Inserts with more than 1 tip on customer request

PCBN Turning Inserts

Coating/ Wiper / Chip-breaker

H K S

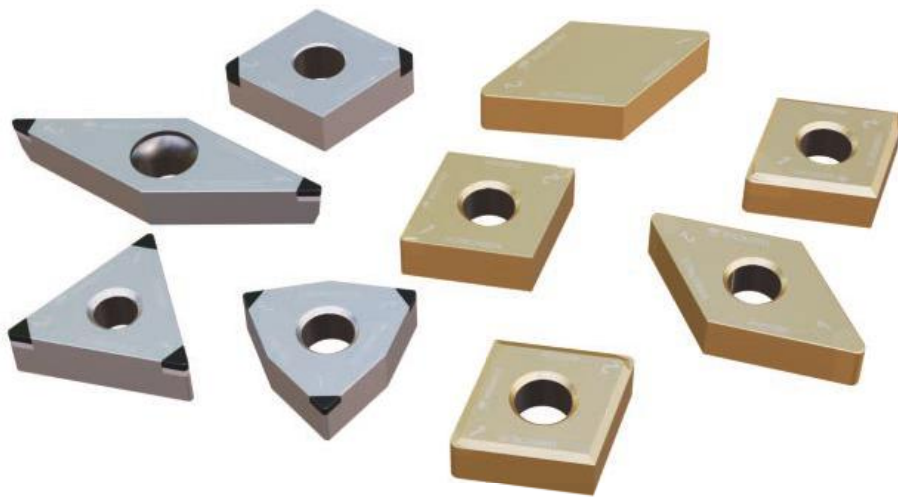

Worldia PCBN Overview

Coating/ Wiper / Chip-breaker

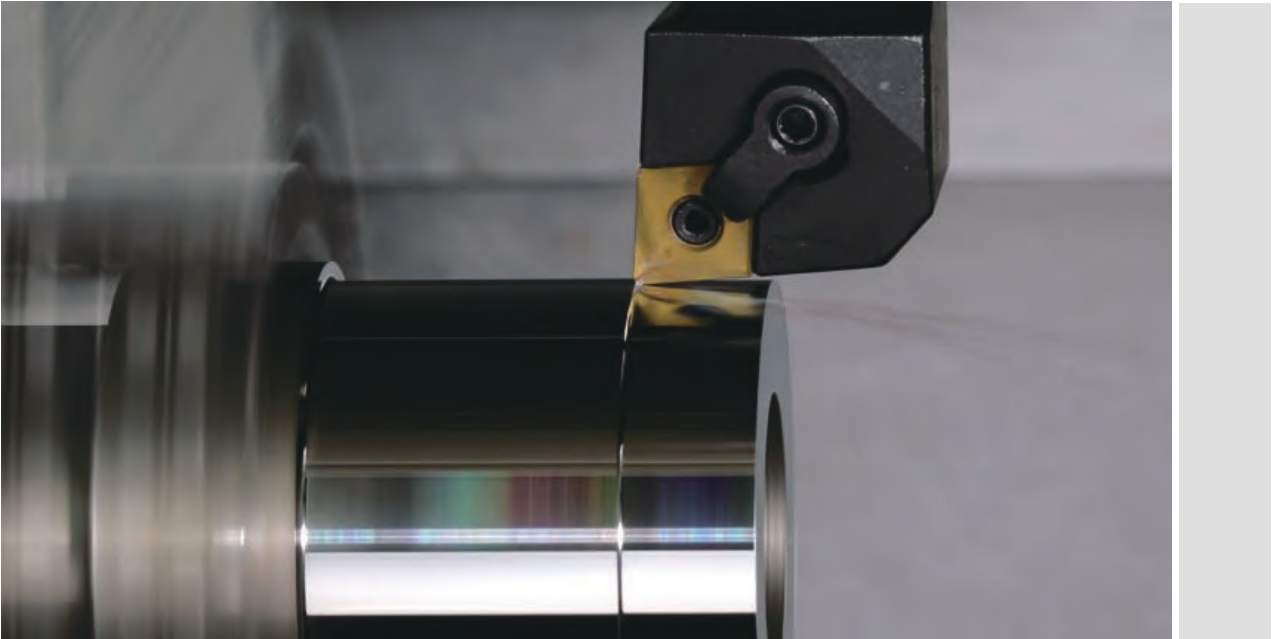

Introduction:

Cubic boron nitride (CBN) is the second hardest material in the world invented successfully in 1957; the microhardness of CBN's single crystal is HV8000-9000 while the hardness of PCBN is HV2500-5000, so it is considerably better abrasive resistance than cemented carbide and ceramics. With a higher ability of oxidation resistance within 1000 °C, CBN will not have any chemical reaction with ferrous material at 1200-1300 °C. So it is unique for CBN material dry cutting ferrous materials. The principal application areas for CBN cutting tools are hardened steels, cast irons and sintered irons as well as powder metallurgy components.







Turning hardened steel with PCBN tools has the following advantages over grinding methods: 1. Low Cost. Reducing the cost of purchasing new machine tools. It allows for complex surfaces to be finished at once, which shortens the production cycle. 2. High Quality. Improving the dimensional and geometrical tolerance with once-champing machining. 3. Environmentally. Using PCBN cutting tools for dry cutting is environmentally friendly and promotes resource recycling.

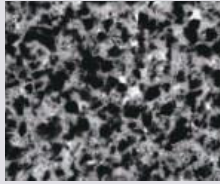
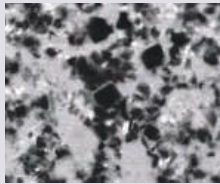

PCBN Material Introduction H

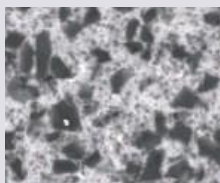
Hardened steel / Cast iron / Powder metallurgy

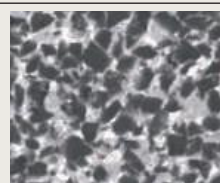
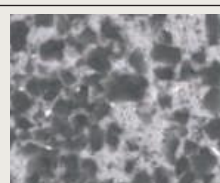
Hardened Steel Machining





Grade	Content (%)	Grain (μm)	Bond	Structure	Features
★ PNH0120	45-50	0.5-2	TiC+TiCN		Widely suitable for continuous finishing of hardened steel
PNH0122	45-50	0.5-3	TiN		Suitable for high-speed and continuous cutting with a small safety margin featuring excellent wear resistance
PNH0124	45-50	0.5-2	TiN		Suitable for continuous finishing of hardened steel with better toughness
★ PNH1020	50-55	0.5-2	TiCN		A universal cutting material is suitable for both continuous and interrupted cutting of hardened steel
PNH1022	50-55	0.5-3	TiCN		Suitable for both continuous and interrupted cutting of hardened steel with excellent wear resistance and high-temperature resistance
PNH1024	55-60	1-4	TiN		Suitable for continuous to interrupted cutting with high-feed and high-speed featuring excellent toughness
★ PNH2016	60-65	0.5-3	TiN		Suitable for interrupted cutting as well as removing carburized layers with excellent toughness and high temperature resistance
PNH2018	60-65	0.5-1	TiN		Suitable for light to medium interrupted cutting for high hardness hardened steel with excellent edge anti-breakage performance

★ This mark indicates this material is the preferred material, depending on the actual working condition

PCBN Material Introduction H

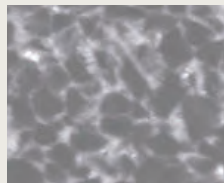
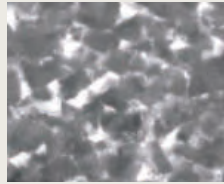
Hardened steel / Cast iron / Powder metallurgy

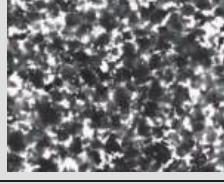
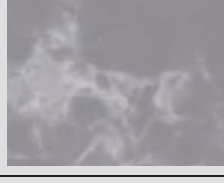
Hardened Steel Machining

Grade	Content (%)	Grain (μm)	Bond	Structure	Features
PNH2024	65-70	2-4	TiN		Suitable for high-feed and heavy interrupted cutting with a large safety margin featuring excellent toughness and high-temperature resistance
PNH2026	70-75	2-4	TiN		The solid PCBN inserts are suitable for heavy roughing of hardened steel with better toughness
PNH2028	65-70	2-4	TiN		The solid PCBN inserts are suitable for continuous to interrupted and heavy cutting of hardened steel with better high-temperature resistance
★PNH3019	85-90	1-2	Metallic compound		Suitable for heavy interrupted of hardened steel with excellent fracture resistance and toughness.
PNH3020	85-90	5-30	Metallic compound		Suitable for continuous to interrupted cutting with a large safety margin and high-feed featuring excellent impact resistance and wear resistance.
PNH3023	90-95	0.5-1	Metallic compound		Suitable for heavy interrupted cutting of hardened steel with excellent toughness and fracture resistance.

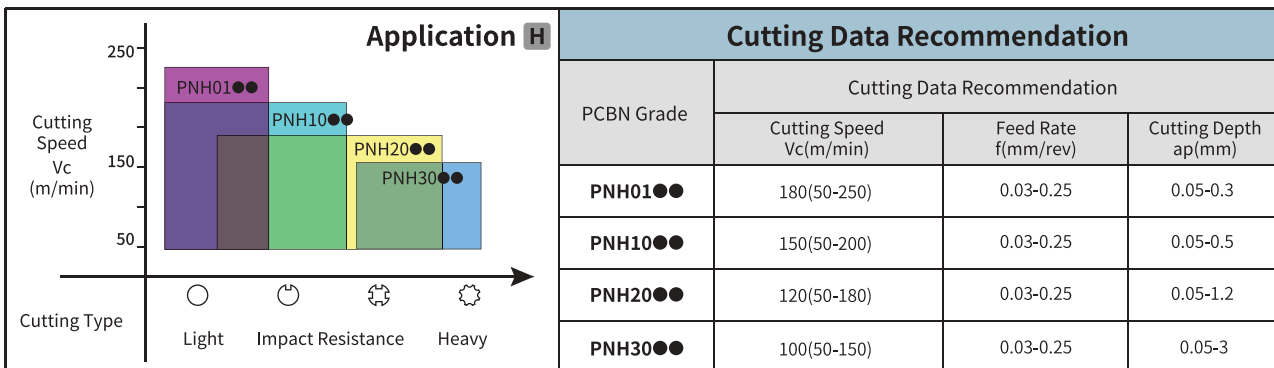



★ This mark indicates this material is the preferred material, depending on the actual working condition

PCBN Material Introduction K

Hardened steel / Cast iron / Powder metallurgy

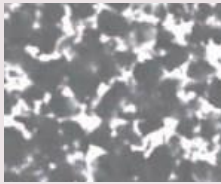
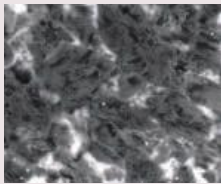
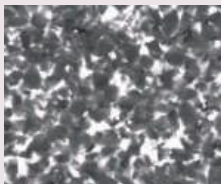
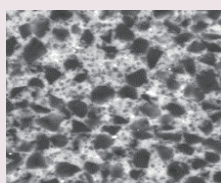
Cast Iron Machining

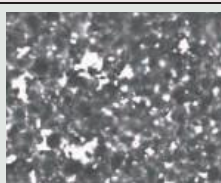
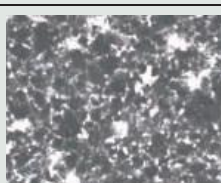
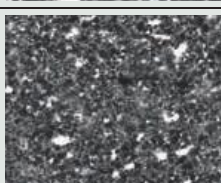
Grade	Content (%)	Grain (μm)	Bond	Structure	Features
★ PNK0107	90-95	3-5	Metallic compound		Suitable for continuous and interrupted cutting of gray iron with excellent toughness
PNK0110	85-90	4-10	Metallic compound		Suitable for heavy-duty cutting during rough machining of gray iron featuring exceptional wear resistance
PNK0118	90-95	2-4	Metallic compound		The solid PCBN insert is suitable for finishing of gray iron
★ PNK0122	50-55	0.5-2	Special ceramic bond		Suitable for both continuous and interrupted finishing of ductile iron featuring excellent high-temperature resistance
PNK0126	50-55	1-2	Special ceramic bond		Suitable for continuous finishing of ductile iron at high cutting speeds featuring excellent toughness and high-temperature resistance
★ PNK3003	85-90	1-2	Metallic compound		Widely suitable for finishing and semi-finishing of gray iron
PNK3007	85-90	1-4	Metallic compound		Suitable for interrupted cutting of gray iron with excellent toughness,
PNK3013	90-95	0.5-1.5	Metallic compound		Ultra-micro grain size PCBN with excellent toughness and sharp edges for stable gray iron finishing

★ This mark indicates this material is the preferred material, depending on the actual working condition

PCBN Material Introduction **K**

Hardened steel / Cast iron / Powder metallurgy

Cast Iron Machining

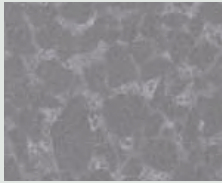
Grade	Content (%)	Grain (μm)	Bond	Structure	Features
PNK3020	85-90	4-30	Metallic compound		The solid PCBN insert with excellent wear resistance is suitable for rough machining of cast iron

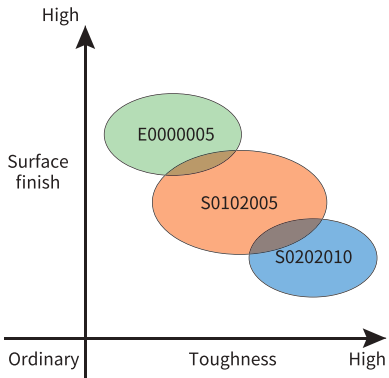
Application K 	Cutting Data Recommendation					
	Material to be machined		PCBN Grade	Cutting Recommendation		
	Material	Specification		Cutting Speed Vc(m/min)	Feed Rate f(mm/rev)	Cutting Depth ap(mm)
Cast Iron	HT200-300	PNK0110	350-1000	0.1-0.5	0.1-0.5	
		PNK0118	350-1200	0.1-0.5	0.1-1	
		PNK0107	350-1200	0.1-0.5	0.1-0.5	
		PNK3003	350-1200	0.1-0.5	0.1-0.5	
		PNK3007	350-1200	0.1-0.5	0.1-0.5	
		PNK3013	350-1200	0.1-0.5	0.1-0.5	
		PNK3020	350-1000	0.1-0.5	0.1-3	
Ductile Iron	QT500-700	PNK0122	250-350	0.1-0.3	0.1-0.5	
		PNK0126	300-600	0.1-0.3	0.1-0.5	



Sharp Cutting Edge: E0000005
 Standard Cutting Edge: S0102005
 Strong Cutting Edge: S0202010

★ This mark indicates this material is the preferred material, depending on the actual working condition

PCBN Material Introduction S

Hardened steel / Cast iron / Powder metallurgy

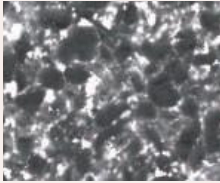
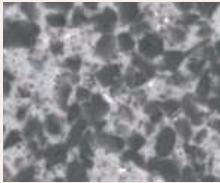
Powder metallurgy Machining

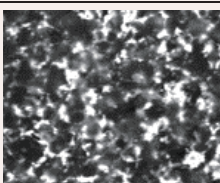
Grade	Content (%)	Grain (μm)	Bond	Structure	Features
PNS0117	85-90	1-4	Metallic compound		Suitable for continuous processing in powder metallurgy with excellent anti-cracking resistance and outstanding chemical stability
★ PNS0126	60-65	0.5-3	TiN		Suitable for hardening of powder metallurgy with excellent high-temperature resistance
PNS2005	90-95	0.5-1.5	Metallic compound		Suitable for finishing and interrupted cutting of powder metallurgy with excellent toughness and sharpness
★ PNS2017	85-95	1-2	Metallic compound		A universal grade for machining powder metallurgy
PNS2019	85-90	1-3	Metallic compound		Suitable for interrupted cutting of powder metallurgy featuring excellent toughness and wear resistance

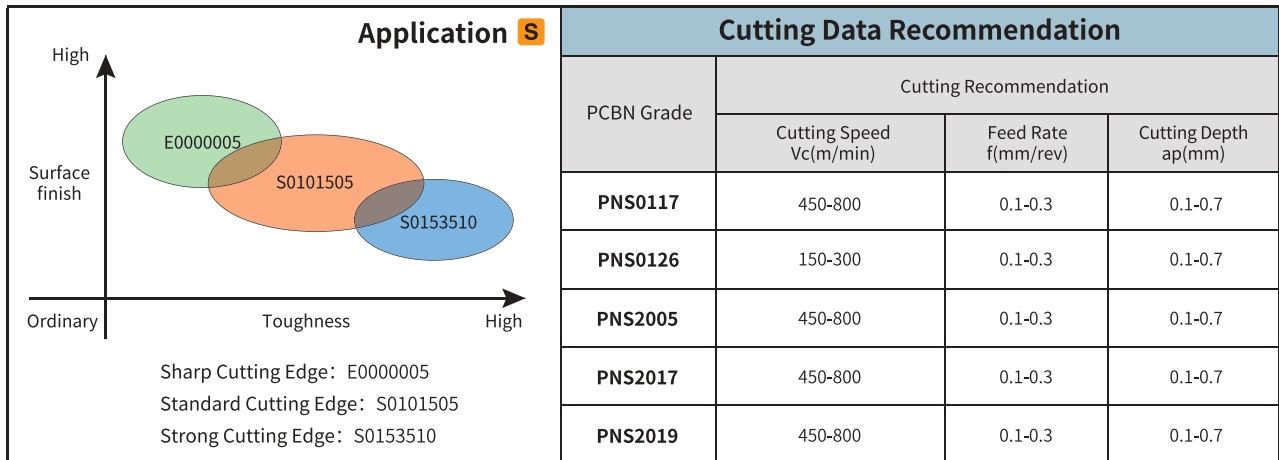

★ This mark indicates this material is the preferred material, depending on the actual working condition

Application Case Studies and Worldia Recommendations

PNH0120

Workpiece: Hollow input shaft Workpiece material: 20CrNiMo
 Hardness: 80HRAmin Machining part: Inner hole
 Cooling type: Liquid coolant Machining condition: Continuous cutting
 Surface finish: Ra1.2 Allowance: 0.15mm



	Previous	Worldia
Insert	CCGW09T308-2N	CCGW09T308-2N
Grade	PCBN	PNH0120
Cutting edge	-	S0102005 SLWG22C3
Coating	Coated	C3
Ap(mm)	0.1	0.1
Vc(m/min)	160	160
Feed(mm/rev)	0.15	0.15

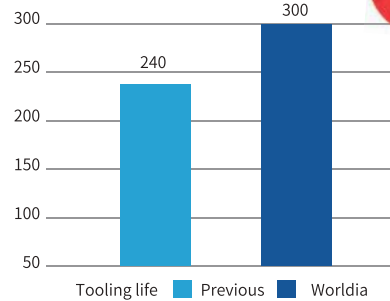

PNH1022

Workpiece: Bearing outer ring Workpiece material: G20CrNiMo
 Hardness: HRC48-62 Machining part: End face & Outer diameter
 Cooling type: Liquid coolant Machining condition: Continuous cutting
 Surface finish: Ra1.6 Allowance: 1.1mm for outer circle/ 1.7mm for end face



	Previous	Worldia
Insert	CNGA120408-2N	CNGA120408-2N
Grade	PCBN	PNH1022
Cutting edge	—	S0153510 SLST30CE
Coating	Coated	CE
Ap(mm)	0.3	0.3
Vc(m/min)	180	180
Feed(mm/rev)	0.25	0.25

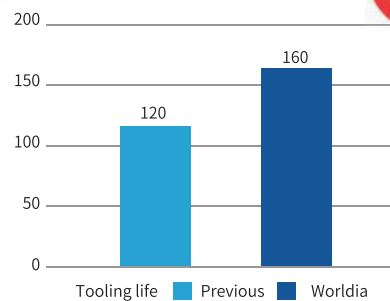

PNH1024

Workpiece: Wheel bearing Workpiece material: Hardened steel
 Hardness: HRC58~62 Machining part: Ball track
 Cooling type: Liquid coolant Machining condition: Continuous finishing
 Surface finish: Ra1.6 Allowance: 0.15mm



	Previous	Worldia
Insert	VNGA160408-4N	VNGA160408-4N
Grade	PCBN	PNH1024
Cutting edge	—	S0153510 SLST22CE
Coating	Coated	CE
Ap(mm)	0.15	0.15
Vc(m/min)	250	250
Feed(mm/rev)	0.16	0.16

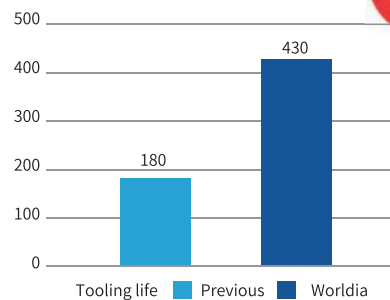

Application Case Studies and Worldia Recommendations

PNH2016

Workpiece: Pump drive wheel Workpiece material: 16MnCr5
 Hardness: 680HV1 Machining part: End face& Inner hole & Chamfer
 Cooling type: Liquid coolant Operation type: Continuous cutting
 Surface finish: Rz6.3 Allowance: 0.15mm



	Previous	Worldia
Insert	VCGW110304-2N	VCGW110304-2N
Grade	PCBN	PNH2016
Cutting edge	—	S0152510 SLST22C3
Coating	Coated	C3
Ap(mm)	0.08	0.08
Vc(m/min)	120	120
Feed(mm/rev)	0.15	0.15

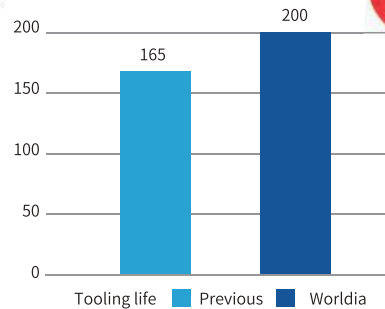

PNH2024

Workpiece: Reducer gear
 Hardness: HRC58~62
 Operation type: Continuous and heavy interrupted cutting
 Surface finish: Ra0.8
 Workpiece material: 20CrMoT1
 Machining part: End face/ Inner hole
 Cooling type: Liquid coolant
 Machining allowance: 0.15mm

	Previous	Worldia
Insert	CNGA120408	CNGA120408
Grade	PCBN	PNH2024
Cutting edge	—	S0152510 SLST22C3
Coating	Coated	C3
Ap(mm)	0.25	0.25
Vc(m/min)	150	150
Feed(mm/rev)	0.25	0.25

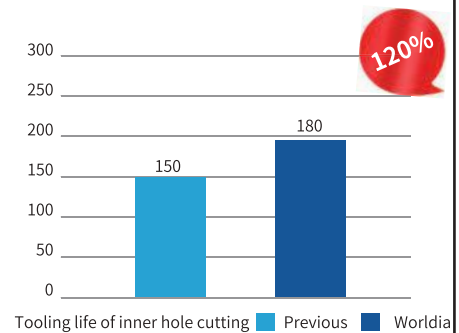
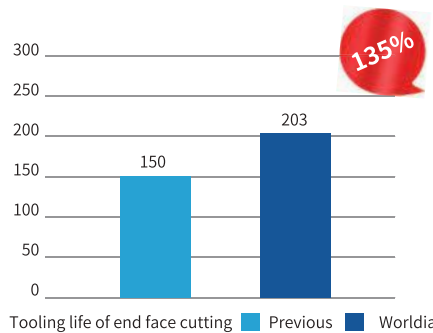

PNH3019

Workpiece: Outer star wheel Workpiece material: UC1-Q
 Hardness: HRC58~62 Machining part: Ball surface
 Cooling type: Air cooling Machining condition: Heavy interrupted cutting
 Surface finish: Ra0.8 Allowance: 0.2mm



	Previous	Worldia
Insert	TNGA160416-3N	TNGA160416-3N
Grade	PCBN	PNH3019
Cutting edge	—	S0152510 SLST22S
Coating	Uncoated	Uncoated
Ap(mm)	0.2	0.2
Vc(m/min)	160	160
Feed(mm/rev)	0.12	0.12

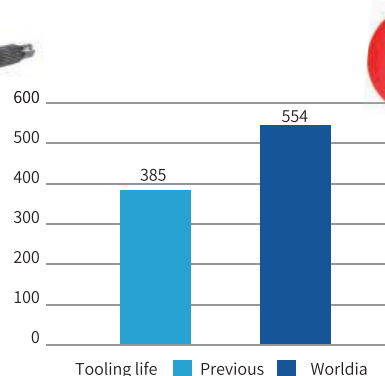

Application Case Studies and Worldia Recommendations

PNH3023

Workpiece: Spindle
 Hardness: HRC58~62
 Cooling type: Dry cutting
 Surface finish: Ra0.8

Workpiece material: ETN22-X
 Machining part: End face
 Machining condition: Heavy interrupted cutting
 Machining allowance: 0.2mm



128%

	Previous	Worldia
Insert	VNGA160404-2N	VNGA160404-2N
Grade	PCBN	PNH3023
Cutting edge	—	S0152510 SLST22C3
Coating	Coated	C3
Ap(mm)	0.2	0.2
Vc(m/min)	90	90
Feed(mm/rev)	0.06	0.06

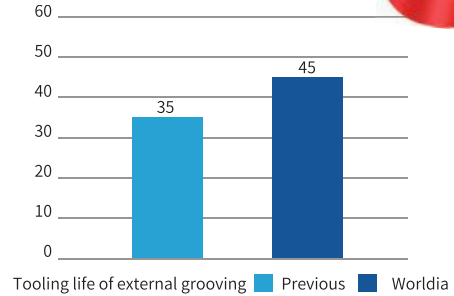

PNK0122

Workpiece: Differential
 Hardness: HB220-240
 Workpiece material: Ductile iron600-3
 Machining part: End face / Outer dia
 Machining condition: Continuous and interrupted cutting
 Surface finish: Ra3.2
 Cooling type: Liquid coolant
 Allowance: 0.6mm

	Previous	Worldia
Insert	CNGA120412-2N	CNGA120412-2N
Grade	Carbide	PNK0122
Cutting edge	—	S0202010 SLST22S
Coating	Uncoated	Uncoated
Ap(mm)	0.6	0.6
Vc(m/min)	240	350
Feed(mm/rev)	0.3	0.3

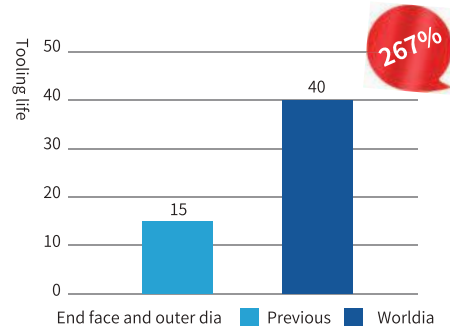
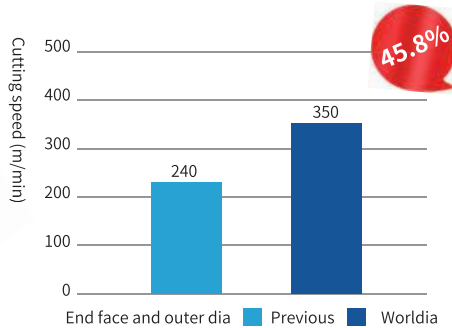

PNK0122

Workpiece: Scroll
 Hardness: HB190~220
 Cooling type: Liquid coolant
 Surface finish: Ra0.7

Workpiece material: QT500
 Machining part: End face
 Machining condition: Interrupted finishing
 Flatness: 0.02



144%

	Previous	Worldia
Insert	DCGW11T308-2N	DCGW11T308-2N
Grade	PCBN	PNK0122
Cutting edge	—	S0102005 SLST22S
Coating	Uncoated	Uncoated
Ap(mm)	0.15	0.15
Vc(m/min)	550	550
Feed(mm/rev)	0.1	0.1

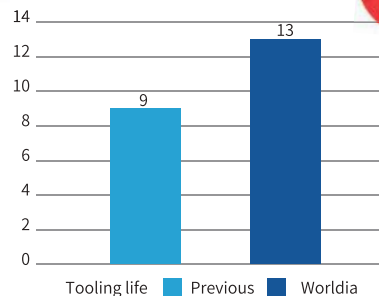

Application Case Studies and Worldia Recommendations

PNK0126

Workpiece: Bush bearing Workpiece material: QT700
 Hardness: HB217-269 Machining part: Outer diameter & End face
 Cooling type: Liquid coolant Allowance: 0.2mm
 Surface finish: Ra2.0



	Previous	Worldia
Insert	DNCA150408-2N	DNCA150408-2N
Grade	PCBN	PNK0126
Cutting edge	—	S0102005 SLST22S
Coating	Uncoated	Uncoated
Ap(mm)	0.2	0.2
Vc(m/min)	130	130
Feed(mm/rev)	0.2	0.2

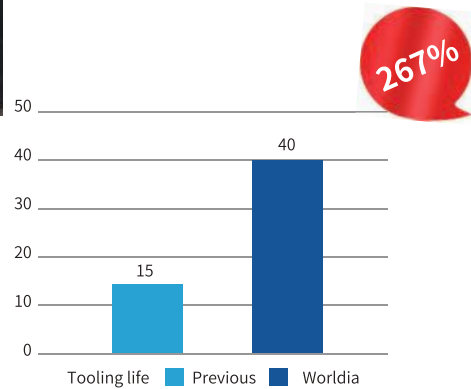

PNK3003

Workpiece: Cylinder block Workpiece material: HT250
 Hardness: HB190-220 Machining part: Inner hole
 Cooling type: Dry cutting Machining condition: Continuous cutting
 Surface finish: Rz10~20 Allowance: 0.065/0.2mm



	Previous	Worldia
Insert	CCGW09T308-2N	CCGW09T308-2N
Grade	PCBN	PNK3003
Cutting edge	—	S0102005 SLST22S
Coating	Uncoated	Uncoated
Ap(mm)	0.065/0.2	0.065/0.2
Vc(m/min)	745	745
Feed(mm/rev)	0.15	0.15

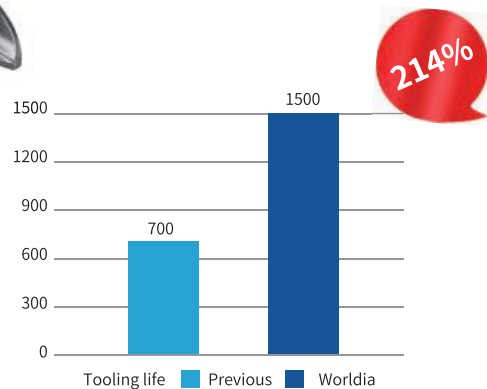

PNS2005

Workpiece: Gear Hub
 Hardness: HB180~220
 Workpiece material: Powder metallurgy
 Machining part: End face / Inner hole
 Machining condition: Interrupted Cutting
 Surface finish: Ra6.3
 Cooling type: Dry Cutting
 Machining allowance: 0.15mm

	Previous	Worldia
Insert	VCGW110306	VCGW110306
Grade	PCBN	PNS2005
Cutting edge	—	S0101505 SLST22S
Coating	Uncoated	Uncoated
Ap(mm)	0.15	0.15
Vc(m/min)	1200	1500
Feed(mm/rev)	0.05	0.05

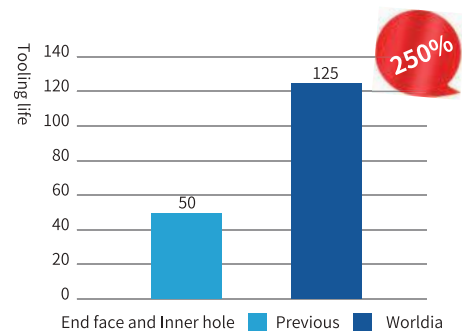
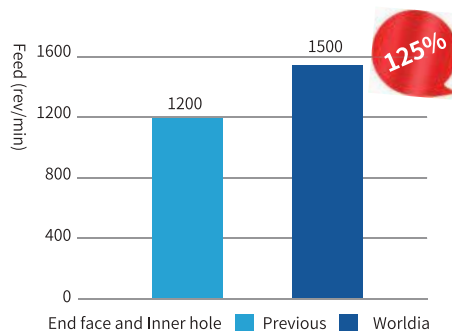

Application Case Studies and Worldia Recommendations

PNS2007

Workpiece: Rotor
 Workpiece material: Powder metallurgy
 Hardness: HRC58~62
 Machining part: End face and inner hole
 Cooling type: Liquid coolant
 Machining condition: Continuous and interrupted cutting
 Surface finish: Rz6.3
 Machining allowance: 0.2mm



	Previous	Worldia
Insert	DCGW11T302-2N	DCGW11T302-2N
Grade	PCBN	PNS2007
Cutting edge	—	S0101505 SLST22S
Coating	Uncoated	Uncoated
Ap(mm)	0.2	0.2
Vc(m/min)	250	250
Feed(mm/rev)	0.06	0.06

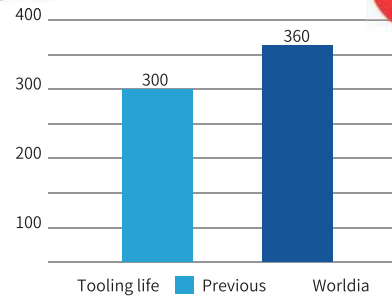

PNS2019

Workpiece: Timing camshaft sprocket
 Workpiece material: Powder metallurgy
 Hardness: HB180~220
 Machining part: End face
 Cooling type: Dry Cutting
 Machining condition: Light interrupted cutting
 Surface finish: Ra1.2
 Flatness: 0.02



	Previous	Worldia
Insert	DCGW11T308-2N	DCGW11T308-2N
Grade	PCBN	PNS2019
Cutting edge	—	S0153510 SLST22S
Coating	Uncoated	Uncoated
Ap(mm)	0.1	0.1
Vc(m/min)	1900	2400
Feed(mm/rev)	0.09	0.07

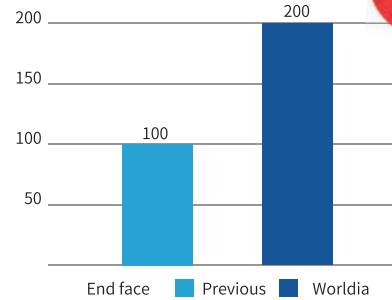

PNS2019

Workpiece: Camshaft
 Workpiece material: Powder metallurgy
 Hardness: HB180~220
 Machining part: End face
 Cooling type: Liquid coolant
 Machining condition: Continuous finishing
 Surface finish: Ra0.8
 Flatness: 0.3



	Previous	Worldia
Insert	VBGW160408-2N	VBGW160408-2N
Grade	PCBN	PNS2019
Cutting edge	—	S0101505 SLST22S
Coating	Uncoated	Uncoated
Ap(mm)	0.3	0.3
Vc(m/min)	210	210
Feed(mm/rev)	0.1	0.1

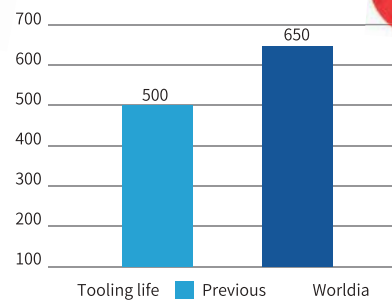

Coating Introduction

CE Coating/ C3 Coating

Applying a PVD coating on the CBN surface can extend the lifespan of tools and enhance precision, particularly in the case of hardened steel machining.

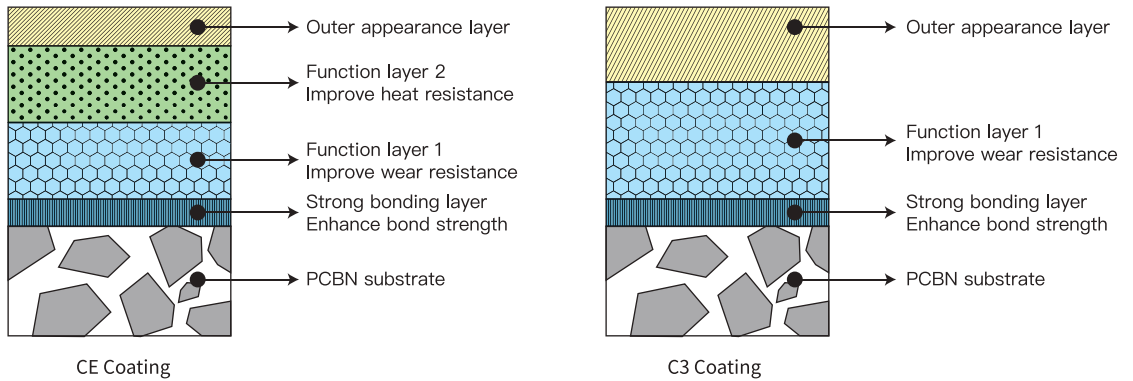

Application of CE/ C3 Coating

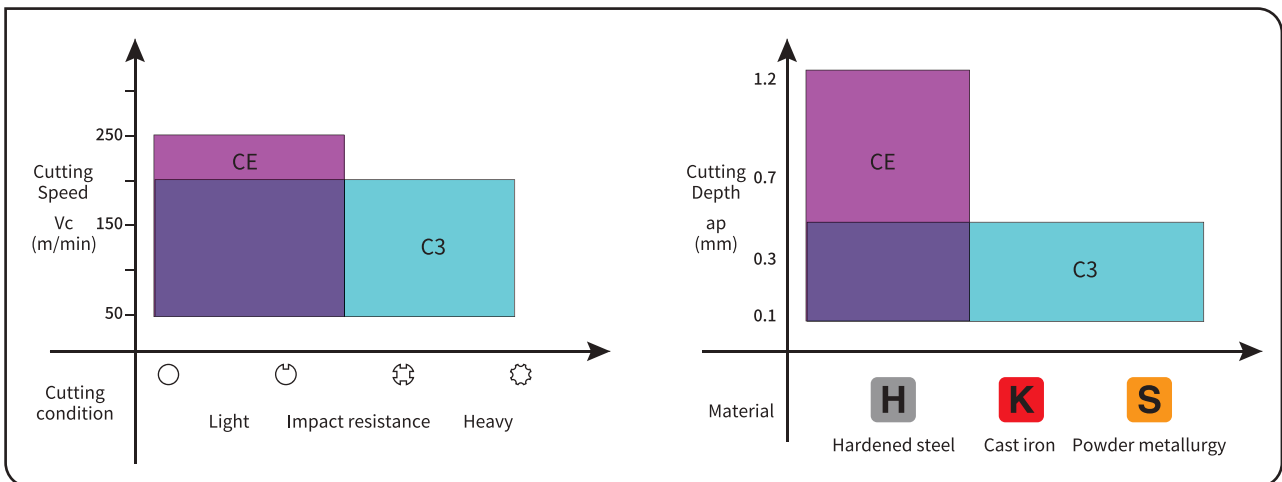

Cutting Performance of CE/ C3 Coating

Material: GCr15 Hardness: HRC58-62
 Cutting speed: 220m/min Cutting depth: 0.1mm Feed: 0.12mm/rev Dry cutting

Material: GCr15 Hardness: HRC58-62
 Cutting speed: 150m/min Cutting depth: 0.15mm Feed: 0.1mm/rev Dry cutting

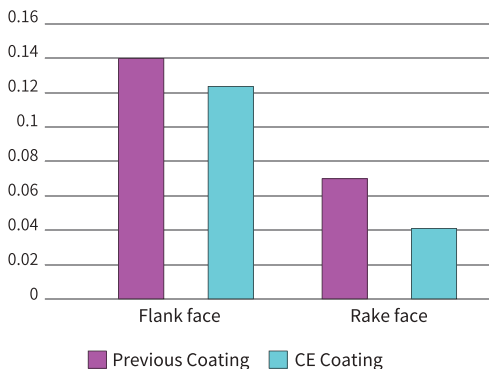
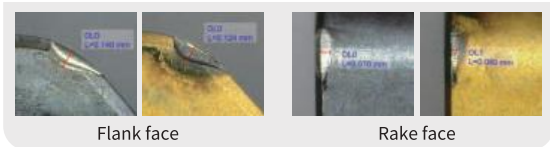

Wear resistance comparison of CE/previous coating

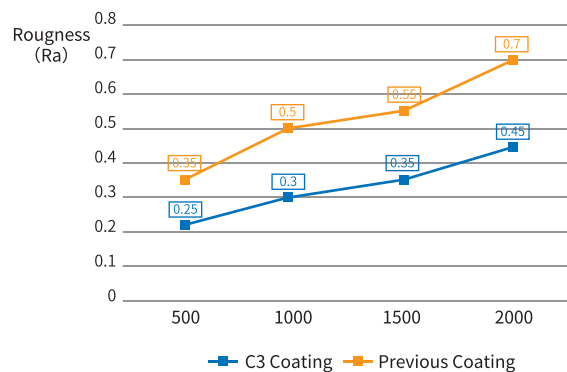

Wear resistance comparison of C3/previous coating

Wiper Introduction

Hardened steel, cast iron, powder metallurgy

Wiper Insert

- Good surface roughness:

Surface roughness can be significantly improved under the same machining conditions, resulting in higher machining quality.

- High efficiency

The feed rate can be significantly increased to meet the same surface roughness requirements, resulting in improved machining efficiency.

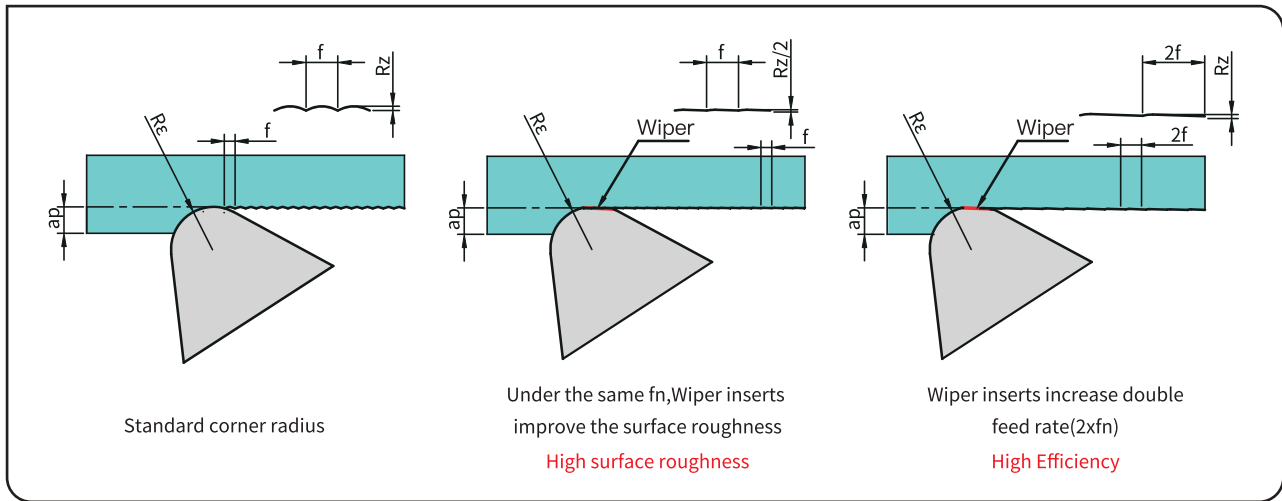

■ Calculation of theoretical value of machined surface roughness for standard corner inserts

$$R_z = \frac{f^2}{8r_\epsilon} * 1000$$

$R_z(\mu\text{m})$: Theoretical surface roughness

$f(\text{mm/rev})$: Feed per revolution

$r_\epsilon(\text{mm})$: Radius of the tip circle

Tip radius r (mm)	Roughness requirements $R_a(\mu\text{m})$				
	0.2	0.4	0.8	1.6	3.2
	Feed f (mm/rev)				
02	0.036	0.05	0.072	0.101	0.143
04	0.05	0.072	0.101	0.143	0.202
08	0.072	0.101	0.143	0.202	0.286
12	0.088	0.124	0.175	0.248	0.351
16	0.101	0.143	0.202	0.286	0.405
0.4/0.8/1.2 Wiper	0.16	0.226	0.315	0.426	0.575

Note

- Wiper inserts are suitable for highly rigid machines and workpieces with high cutting resistance.
- It is important to use the appropriate type of holder with wiper inserts.
- Using the reverse cutting direction with wiper inserts is not recommended.

Chip Breaker Introduction

CBC1/CBR4



In the cutting process, long continuous chip will cause many problems such as long chip will be wrapped around the surface of the work piece, the surface is scratched, the tool life is unstable, repeated positioning is not accurate, the manipulator can not work normally, the automatic detection system can not work well etc.

Worldia's standard inserts with CBC1, CBC4 and CBC6 chip breaker, are suitable for finishing, semi-finishing, roughing as well as for removing carburized layers during roughing.

CBC1 is suitable for finishing chipbreaking, CBR4 is suitable for semi-finishing and roughing, and CBR6 is suitable for roughing and high-efficiency machining with large allowances and high feed rates.

When combined with Worldia's C3 and CE coatings, these chipbreaker inserts can fully leverage their excellent heat and wear resistance, thereby extending the tool life.

Application

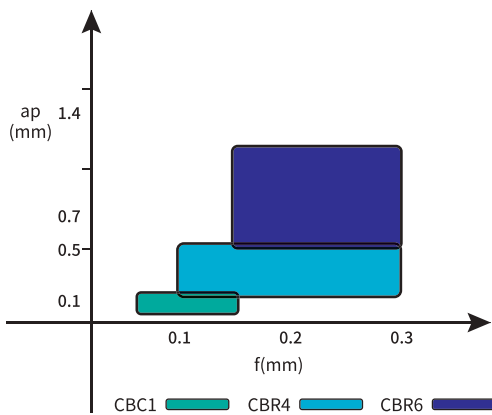

Structure

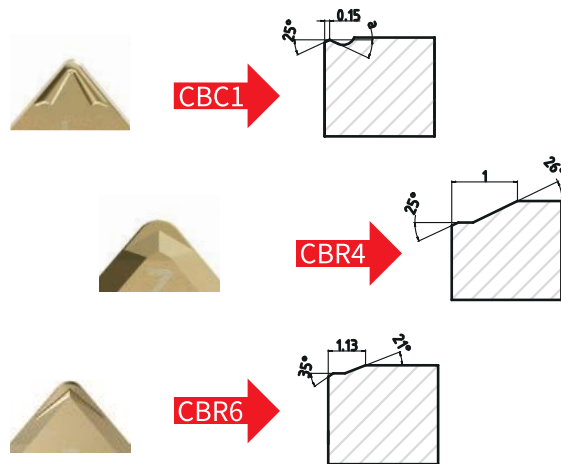

Cutting performance



Workpiece Material: GCr15 HRC58-62
 Parameter: CNGM120408-2N SLCBC122C3
 Cutting Data: Vc=150m/min f=0.12mm/rev ap=0.15mm



Workpiece Material: 20CrMoTi HRC58
 Parameter: DNGM150408-2N SLCBR430C3
 Cutting Data: Vc=160m/min f=0.15mm/rev ap=0.4mm



Workpiece Material: 20CrMoTi HRC58-62
 Parameter: CNGA120408-2N SLCBR640CE
 Cutting Data: Vc=130m/min f=0.15mm/rev ap=1.3 干切

Nomenclature

Rule of Worldia PCBN Insert Code

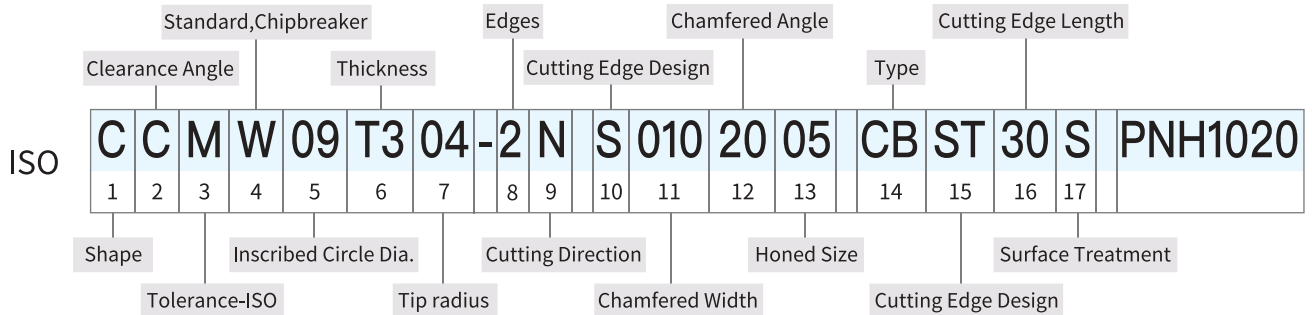

1. Shape					
	H	Hexagon		Diamond	
		120°		C 80°	
	O	Octagonal		D 55°	
		135°		E 75°	
	P	Pentagon		M 86°	
		108°		V 35°	
	R	Round		W Hexagon	
		90°		80°	
	S	Square		L Rectangular	
		90°		90°	
	T	Triangle		A Diamond	
				85°	B 82°
				60°	K 55°

3. Tolerance-ISO								
	Code	Tolerance			Code	inch		
		m	s	IC		m	ic	s
	C	±0.013	±0.025	±0.025	C	±.0005	±.001	±.001
	H	±0.013	±0.025	±0.013	H	±.0005	±.0005	±.001
	E	±0.025	±0.025	±0.025	E	±.001	±.001	±.001
	G	±0.025	±0.13	±0.025	G	±.001	±.001	±.005
	K	±0.013	±0.025	±0.05-±0.13	K	±.0005	±.002-.005	±.001
	M	±0.08-±0.18	±0.13	±0.05-±0.13	M	±.002-.005	±.002-.005	±.005
	U	±0.13-±0.38	±0.13	±0.08-±0.25	U	±.005-.012	±.005-.010	±.005

2. Clearance Angle			
	A		E
	B		F
	C		G
	D		N
	P		O

5. Inscribed Circle Dia.									
ISO							ANSI		
Edge length (accoring insert shape)						Inscribed Circle Dia.	Code	IC Size	
C	D	R	S	T	V	W	mm		inch
S4	04	03	03	06	-	02	3.97	(1.2)	5/32
04	05	04	04	08	08	S3	4.76	(1.5)	3/16
05	06	05	05	09	09	03	5.56	(1.8)	7/32
-	-	06	-	-	-	-	6	-	-
06	07	06	06	11	11	04	6.35	2	1/4
08	09	07	07	13	13	05	7.94	(2.5)	5/16
-	-	08	-	-	-	-	8	-	-
09	11	09	09	16	16	06	9.525	3	3/8
-	-	10	-	-	-	-	10	-	-
-	-	12	-	-	-	-	12	-	-
12	15	12	12	22	22	08	12.7	4	1/2
16	19	15	15	27	27	10	15.875	5	5/8
-	-	16	-	-	-	-	16	-	-
19	23	19	19	33	33	13	19.05	6	3/4
-	-	20	-	-	-	-	20	-	-
22	27	22	22	38	38	15	22.225	7	7/8
-	-	25	-	-	-	-	25	-	-
25	31	25	25	44	44	17	25.4	8	1
32	38	31	31	54	54	21	31.75	10	1-1/4
-	-	32	-	-	-	-	32	-	-

6. Thickness			
ISO		ANSI	
Code	Size	Code	Size
S	mm	S	inch
01	1.59	1	1/16
02	2.38	(1.5)	3/32
T2	2.78	-	-
03	3.18	2	1/8
T3	3.97	(2.5)	5/32
04	4.76	3	3/16
05	5.56	(3.5)	7/32
06	6.35	4	1/4
07	7.94	5	5/16
09	9.525	6	3/8

7. Tip radius			
ISO		ANSI	
Code	Size	Code	Size
R _c	mm	R _c	inch
00	sharp	00	.000
003	0.03	(0.1)	.001
01	0.1	(0.2)	.004
02	0.2	(0.5)	.008
04	0.4	1	1/64
08	0.8	2	1/32
12	1.2	3	3/64
16	1.6	4	1/16
20	2.0	5	5/64
24	2.4	6	3/32
28	2.8	7	7/64
32	3.2	8	1/8
M00	Round		circular

4. Standard, Chipbreaker			
	N		G
	B		H
	F		T
	C		J
	A		Q
	M		U
		Others	X

Nomenclature

Rule of Worldia PCBN Insert Code

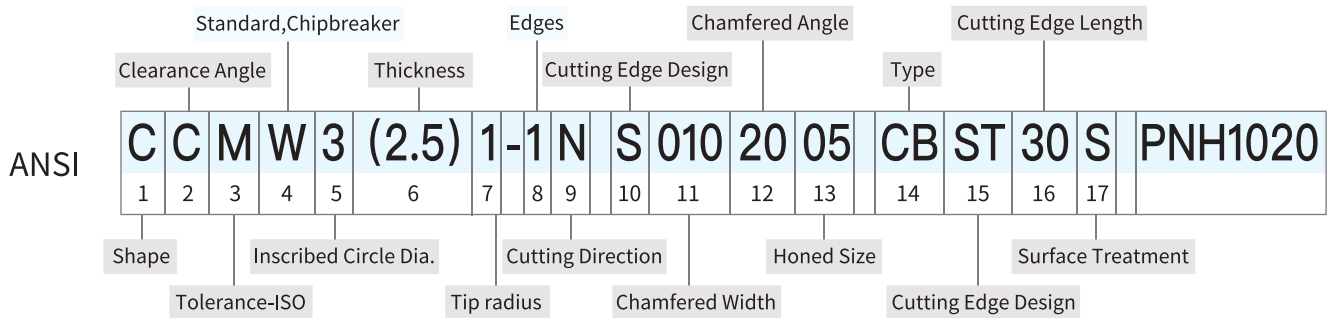

8.Edges							
Code	1	2	3	4	6	8	
Edges	一刃	二刃	三刃	四刃	六刃	八刃	

9.Cutting Direction			
Code	R	L	N

10.Cutting Edge Design			
E	T	S	F
钝化	倒棱	倒棱+钝化	锋利刃口

11.Chamfered Width						
Code	000	005	010	015	020	030
Size	-	0.05	0.1	0.15	0.2	0.3

12.Chamfered Angle									
Code	α	00	10	15	20	25	30	35	45
Size	°	-	10	15	20	25	30	35	45

13.Honed Size						
Code	00	02	05	10	20	30

14.Type						
SF	SL	SS	CB	CS	SWW	SWU
Full Face	Solid Tipped Corner	Solid CBN	Standard Tipped Corners	Standard Full Edge	Solid Tipped Corners Type "W"	Solid Tipped Corners Type "U"

15.Cutting Edge Design		
ST	WG	CB
Nose Radius	Wiper	Chip Breaker

16. Cutting Edge Length						
Code	Ap	22	25	28	30	40
Size		2.2	2.5	2.8	3.0	4.0

17.Surface Treatment	
S	Uncoated
C3	Coated
CE	Coated

PCBN insert -Hardened Steel

Tipped Inserts

CC	80° rhombic-Positive-With hole
	PCBN Positive

H				
Applications				
Structure	SL	SL	SL	CB
Material code	PNH0120 PNH0122 PNH0124	PNH1020 PNH1022 PNH1024	PNH2016 PNH2018 PNH2024	PNH3019 PNH3023
Cutting edge	S0054505 S0102005 S0152510	S0152510 S0153510	S0152510 S0153510 S0203520	S0102005 S0153510
Coating	S/C3/CE	S/C3/CE	S/C3/CE	S/C3

Shape	ISO	ANSI	Tips forming		Cutting edges	ic	φd	S	r	la
 Conventional mini type	CCGW060202-2N	CCGW2(1.5) (0.5)-2N		□□ST22S	2	6.35	2.8	2.38	0.2	2.2
	060204-2N	2(1.5)1-2N		□□WGR22S	2				0.4	
	060208-2N	2(1.5)2-2N		□□CBR422S	2				0.8	
	CCGW060202-2N	CCGW2(1.5) (0.5)-2N		□□ST30S	2				0.2	
	060204-2N	2(1.5)1-2N		□□WGR30S	2				0.4	
	060208-2N	2(1.5)2-2N		□□CBR430S	2				0.8	
	CCGW060202-2N	CCGW2(1.5) (0.5)-2N		□□ST30S	2				0.2	
	060204-2N	2(1.5)1-2N		□□WGR30S	2				0.4	
	060208-2N	2(1.5)2-2N		□□CBR430S	2				0.8	
 Standard type	CCGW060202-2N	CCGW2(1.5) (0.5)-2N		□□ST22S	2	6.35	2.8	2.38	0.2	3.0
	060204-2N	2(1.5)1-2N		□□WGR22S	2				0.4	
	060208-2N	2(1.5)2-2N		□□CBR422S	2				0.8	
	CCGW060202-2N	CCGW2(1.5) (0.5)-2N		□□ST30S	2				0.2	
	060204-2N	2(1.5)1-2N		□□WGR30S	2				0.4	
	060208-2N	2(1.5)2-2N		□□CBR430S	2				0.8	
	CCGW060202-2N	CCGW2(1.5) (0.5)-2N		□□ST30S	2				0.2	
	060204-2N	2(1.5)1-2N		□□WGR30S	2				0.4	
	060208-2N	2(1.5)2-2N		□□CBR430S	2				0.8	

CC	80° rhombic-Positive-With hole
	PCBN Positive

H				
Applications				
Structure	SL	SL	SL	CB
Material code	PNH0120 PNH0122 PNH0124	PNH1020 PNH1022 PNH1024	PNH2016 PNH2018 PNH2024	PNH3019 PNH3023
Cutting edge	S0054505 S0102005 S0152510	S0152510 S0153510	S0152510 S0153510 S0203520	S0102005 S0153510
Coating	S/C3/CE	S/C3/CE	S/C3/CE	S/C3

Shape	ISO	ANSI	Tips forming		Cutting edges	ic	φd	S	r	la
 Conventional mini type	CCGW09T304-2N	CCGW3(2.5)1-2N		□□ST22S	2	9.525	4.4	3.97	0.4	2.2
	09T308-2N	3(2.5)2-2N		□□WGR22S	2				0.8	
	09T312-2N	3(2.5)3-2N		□□CBR422S	2				1.2	
	CCGW09T304-2N	CCGW3(2.5)1-2N		□□ST30S	2				0.4	
	09T308-2N	3(2.5)2-2N		□□WGR30S	2				0.8	
	09T312-2N	3(2.5)3-2N		□□CBR430S	2				1.2	
	CCGW09T304-2N	CCGW3(2.5)1-2N		□□ST30S	2				0.4	
	09T308-2N	3(2.5)2-2N		□□WGR30S	2				0.8	
	09T312-2N	3(2.5)3-2N		□□CBR430S	2				1.2	
 Standard type	CCGW09T304-2N	CCGW3(2.5)1-2N		□□ST22S	2	9.525	4.4	3.97	0.4	3.0
	09T308-2N	3(2.5)2-2N		□□WGR22S	2				0.8	
	09T312-2N	3(2.5)3-2N		□□CBR422S	2				1.2	
	CCGW09T304-2N	CCGW3(2.5)1-2N		□□ST30S	2				0.4	
	09T308-2N	3(2.5)2-2N		□□WGR30S	2				0.8	
	09T312-2N	3(2.5)3-2N		□□CBR430S	2				1.2	
	CCGW09T304-2N	CCGW3(2.5)1-2N		□□ST30S	2				0.4	
	09T308-2N	3(2.5)2-2N		□□WGR30S	2				0.8	
	09T312-2N	3(2.5)3-2N		□□CBR430S	2				1.2	

PCBN insert -Hardened Steel

Tipped Inserts

CC	80° rhombic-Positive-With hole
	PCBN Positive

H				
Applications				
Structure	SL	SL	SL	CB
Material code	PNH0120 PNH0122 PNH0124	PNH1020 PNH1022 PNH1024	PNH2016 PNH2018 PNH2024	PNH3019 PNH3023
Cutting edge	S0054505 S0102005 S0152510	S0152510 S0153510	S0152510 S0153510 S0203520	S0102005 S0153510
Coating	S/C3/CE	S/C3/CE	S/C3/CE	S/C3

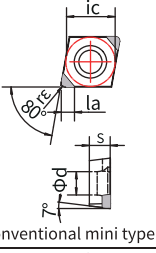
Shape	ISO	ANSI	Tips forming		Cutting edges	ic	φd	S	r	la
 <p>Conventional mini type</p>	CCGW120404-2N	CCGW431-2N		□□ST22S	2	12.7	5.5	4.76	0.4	2.2
	120408-2N	432-2N		□□WGR22S	2				0.8	
	120412-2N	433-2N		□□CBR422S	2				1.2	
	CCGW120404-2N	CCGW431-2N		□□CBR422S	2				0.4	
	120408-2N	432-2N		□□CBR422S	2				0.8	
	120412-2N	433-2N		□□CBR422S	2				1.2	
	CCGW120404-2N	CCGW431-2N		□□ST30S	2				0.4	
	120408-2N	432-2N		□□ST30S	2				0.8	
	120412-2N	433-2N		□□ST30S	2				1.2	
 <p>Standard type</p>	CCGW120404-2N	CCGW431-2N		□□ST30S	2	12.7	5.5	4.76	0.4	3.0
	120408-2N	432-2N		□□WGR30S	2				0.8	
	120412-2N	433-2N		□□WGR30S	2				1.2	
	CCGW120404-2N	CCGW431-2N		□□CBR430S	2				0.4	
	120408-2N	432-2N		□□CBR430S	2				0.8	
	120412-2N	433-2N		□□CBR430S	2				1.2	
	CCGW120404-2N	CCGW431-2N		□□ST30S	2				0.4	
	120408-2N	432-2N		□□ST30S	2				0.8	
	120412-2N	433-2N		□□ST30S	2				1.2	

DC	55° rhombic-Positive-With hole
	PCBN Positive

H				
Applications				
Structure	SL	SL	SL	CB
Material code	PNH0120 PNH0122 PNH0124	PNH1020 PNH1022 PNH1024	PNH2016 PNH2018 PNH2024	PNH3019 PNH3023
Cutting edge	S0054505 S0102005 S0152510	S0152510 S0153510	S0152510 S0153510 S0203520	S0102005 S0153510
Coating	S/C3/CE	S/C3/CE	S/C3/CE	S/C3

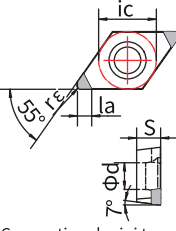
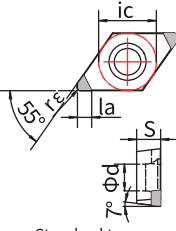
Shape	ISO	ANSI	Tips forming		Cutting edges	ic	φd	S	r	la
 <p>Conventional mini type</p>	DCGW070202-2N	DCGW2(1.5)(0.5)-2N		□□ST22S	2	6.35	2.8	2.38	0.2	2.2
	070204-2N	2(1.5)1-2N		□□WGR22S (107.5°)	2				0.4	
	070208-2N	2(1.5)2-2N		□□WGR22S (107.5°)	2				0.8	
	DCGW070202-2N	DCGW2(1.5)(0.5)-2N		□□CBR422S	2				0.2	
	070204-2N	2(1.5)1-2N		□□CBR422S	2				0.4	
	070208-2N	2(1.5)2-2N		□□CBR422S	2				0.8	
	DCGW070202-2N	DCGW2(1.5)(0.5)-2N		□□ST30S	2				0.2	
	070204-2N	2(1.5)1-2N		□□ST30S	2				0.4	
	070208-2N	2(1.5)2-2N		□□ST30S	2				0.8	
 <p>Standard type</p>	DCGW070202-2N	DCGW2(1.5)(0.5)-2N		□□ST30S	2	6.35	2.8	2.38	0.2	3.0
	070204-2N	2(1.5)1-2N		□□WGR30S (107.5°)	2				0.4	
	070208-2N	2(1.5)2-2N		□□WGR30S (107.5°)	2				0.8	
	DCGW070202-2N	DCGW2(1.5)(0.5)-2N		□□CBR430S	2				0.2	
	070204-2N	2(1.5)1-2N		□□CBR430S	2				0.4	
	070208-2N	2(1.5)2-2N		□□CBR430S	2				0.8	
	DCGW070202-2N	DCGW2(1.5)(0.5)-2N		□□ST30S	2				0.2	
	070204-2N	2(1.5)1-2N		□□ST30S	2				0.4	
	070208-2N	2(1.5)2-2N		□□ST30S	2				0.8	

PCBN insert -Hardened Steel

Tipped Inserts

DC 55°rhombic-Positive-With hole
PCBN Positive

H				
Applications				
Structure	SL	SL	SL	CB
Material code	PNH0120 PNH0122 PNH0124	PNH1020 PNH1022 PNH1024	PNH2016 PNH2018 PNH2024	PNH3019 PNH3023
Cutting edge	S0054505 S0102005 S0152510	S0152510 S0153510	S0152510 S0153510 S0203520	S0102005 S0153510
Coating	S/C3/CE	S/C3/CE	S/C3/CE	S/C3

Shape	ISO	ANSI	Tips forming	Cutting edges	ic	φd	S	r	la	
 Conventional mini type	DCGW11T304-2N	DCGW3(2.5)1-2N		□□ST22S	9.525	4.4	3.97	0.4	2.2	
	11T308-2N	3(2.5)2-2N		□□WGR22S (107.5°)				2		0.8
	11T312-2N	3(2.5)3-2N		□□CBR422S				2		1.2
	DCGW11T304-2N	DCGW3(2.5)1-2N		□□WGR22S (107.5°)				2		0.4
	11T308-2N	3(2.5)2-2N		□□CBR422S				2		0.8
	11T312-2N	3(2.5)3-2N		□□ST30S				2		1.2
	DCGW11T304-2N	DCGW3(2.5)1-2N		□□WGR30S (107.5°)				2		0.4
	11T308-2N	3(2.5)2-2N		□□CBR430S				2		0.8
	11T312-2N	3(2.5)3-2N		□□ST30S				2		1.2
 Standard type	DCGW11T304-2N	DCGW3(2.5)1-2N		□□ST30S	9.525	4.4	3.97	0.4	3.0	
	11T308-2N	3(2.5)2-2N		□□WGR30S (107.5°)				2		0.8
	11T312-2N	3(2.5)3-2N		□□CBR430S				2		1.2
	DCGW11T304-2N	DCGW3(2.5)1-2N		□□WGR30S (107.5°)				2		0.4
	11T308-2N	3(2.5)2-2N		□□CBR430S				2		0.8
	11T312-2N	3(2.5)3-2N		□□ST30S				2		1.2
	DCGW11T304-2N	DCGW3(2.5)1-2N		□□WGR30S (107.5°)				2		0.4
	11T308-2N	3(2.5)2-2N		□□CBR430S				2		0.8
	11T312-2N	3(2.5)3-2N		□□ST30S				2		1.2

DC 55°rhombic-Positive-With hole
PCBN Positive

H				
Applications				
Structure	SL	SL	SL	CB
Material code	PNH0120 PNH0122 PNH0124	PNH1020 PNH1022 PNH1024	PNH2016 PNH2018 PNH2024	PNH3019 PNH3023
Cutting edge	S0054505 S0102005 S0152510	S0152510 S0153510	S0152510 S0153510 S0203520	S0102005 S0153510
Coating	S/C3/CE	S/C3/CE	S/C3/CE	S/C3

Shape	ISO	ANSI	Tips forming	Cutting edges	ic	φd	S	r	la	
 Conventional mini type	DCGW150404-2N	DCGW431-2N		□□ST22S	12.7	5.5	4.76	0.4	2.2	
	150408-2N	432-2N		□□WGR22S (107.5°)				2		0.8
	150412-2N	433-2N		□□CBR422S				2		1.2
	DCGW150404-2N	DCGW431-2N		□□WGR22S (107.5°)				2		0.4
	150408-2N	432-2N		□□CBR422S				2		0.8
	150412-2N	433-2N		□□ST30S				2		1.2
	DCGW150404-2N	DCGW431-2N		□□WGR30S (107.5°)				2		0.4
	150408-2N	432-2N		□□CBR430S				2		0.8
	150412-2N	433-2N		□□ST30S				2		1.2
 Standard type	DCGW150404-2N	DCGW431-2N		□□ST30S	12.7	5.5	4.76	0.4	3.0	
	150408-2N	432-2N		□□WGR30S (107.5°)				2		0.8
	150412-2N	433-2N		□□CBR430S				2		1.2
	DCGW150404-2N	DCGW431-2N		□□WGR30S (107.5°)				2		0.4
	150408-2N	432-2N		□□CBR430S				2		0.8
	150412-2N	433-2N		□□ST30S				2		1.2
	DCGW150404-2N	DCGW431-2N		□□WGR30S (107.5°)				2		0.4
	150408-2N	432-2N		□□CBR430S				2		0.8
	150412-2N	433-2N		□□ST30S				2		1.2

PCBN insert -Hardened Steel

Tipped Inserts

SC	90°Square-Positive-With hole
	PCBN Positive

H				
Applications				
Structure	SL	SL	SL	CB
Material code	PNH0120 PNH0122 PNH0124	PNH1020 PNH1022 PNH1024	PNH2016 PNH2018 PNH2024	PNH3019 PNH3023
Cutting edge	S0054505 S0102005 S0152510	S0152510 S0153510	S0152510 S0153510 S0203520	S0102005 S0153510
Coating	S/C3/CE	S/C3/CE	S/C3/CE	S/C3

Shape	ISO	ANSI	Tips forming		Cutting edges	ic	φd	S	r	la
 Conventional mini type	SCGW09T304-4N	SCGW3(2.5)1-4N		□□ST22S	4	9.525	4.4	3.97	0.4	2.2
	09T308-4N	3(2.5)2-4N							0.8	
	09T312-4N	3(2.5)3-4N							1.2	
	SCGW09T304-4N	SCGW3(2.5)1-4N		□□CBR422S	4				0.4	
	09T308-4N	3(2.5)2-4N							0.8	
	09T312-4N	3(2.5)3-4N							1.2	
 Standard type	SCGW09T304-4N	SCGW3(2.5)1-4N		□□ST30S	4	9.525	4.4	3.97	0.4	3.0
	09T308-4N	3(2.5)2-4N							0.8	
	09T312-4N	3(2.5)3-4N							1.2	
	SCGW09T304-4N	SCGW3(2.5)1-4N		□□CBR430S	4				0.4	
	09T308-4N	3(2.5)2-4N							0.8	
	09T312-4N	3(2.5)3-4N							1.2	

SC	90°Square-Positive-With hole
	PCBN Positive

H				
Applications				
Structure	SL	SL	SL	CB
Material code	PNH0120 PNH0122 PNH0124	PNH1020 PNH1022 PNH1024	PNH2016 PNH2018 PNH2024	PNH3019 PNH3023
Cutting edge	S0054505 S0102005 S0152510	S0152510 S0153510	S0152510 S0153510 S0203520	S0102005 S0153510
Coating	S/C3/CE	S/C3/CE	S/C3/CE	S/C3

Shape	ISO	ANSI	Tips forming		Cutting edges	ic	φd	S	r	la
 Conventional mini type	SCGW120404-4N	SCGW431-4N		□□ST22S	4	12.7	5.5	4.76	0.4	2.2
	120408-4N	432-4N							0.8	
	120412-4N	433-4N							1.2	
	SCGW120404-4N	SCGW431-4N		□□CBR422S	4				0.4	
	120408-4N	432-4N							0.8	
	120412-4N	433-4N							1.2	
 Standard type	SCGW120404-4N	SCGW431-4N		□□ST30S	4	12.7	5.5	4.76	0.4	3.0
	120408-4N	432-4N							0.8	
	120412-4N	433-4N							1.2	
	SCGW120404-4N	SCGW431-4N		□□CBR430S	4				0.4	
	120408-4N	432-4N							0.8	
	120412-4N	433-4N							1.2	

PCBN insert -Hardened Steel

Tipped Inserts

TC/TP 60°Square-Positive-With hole
PCBN Positive

H				
Applications				
Structure	SL	SL	SL	CB
Material code	PNH0120 PNH0122 PNH0124	PNH1020 PNH1022 PNH1024	PNH2016 PNH2018 PNH2024	PNH3019 PNH3023
Cutting edge	S0054505 S0102005 S0152510	S0152510 S0153510	S0152510 S0153510 S0203520	S0102005 S0153510
Coating	S/C3/CE	S/C3/CE	S/C3/CE	S/C3

Shape	ISO	ANSI	Tips forming	Cutting edges	ic	φd	S	r	la
 Conventional mini type	TCGW080202-3N	TCGW(1.5)(1.5)(0.5)-3N		□□ST22S	3	4.76	2.4	2.38	0.2
	080204-3N	(1.5)(1.5)1-3N							0.4
	TPGW080202-3N	TPGW(1.5)(1.5)(0.5)-3N		□□ST22S	3	4.76	2.4	2.38	0.2
	080204-3N	(1.5)(1.5)1-3N							0.4
 Standard type	TCGW080202-3N	TCGW(1.5)(1.5)(0.5)-3N		□□ST30S	3	4.76	2.4	2.38	0.2
	080204-3N	(1.5)(1.5)1-3N							0.4
	TPGW080202-3N	TPGW(1.5)(1.5)(0.5)-3N		□□ST30S	3	4.76	2.4	2.38	0.2
	080204-3N	(1.5)(1.5)1-3N							0.4

TC/TP 60°Square-Positive-With hole
PCBN Positive

H				
Applications				
Structure	SL	SL	SL	CB
Material code	PNH0120 PNH0122 PNH0124	PNH1020 PNH1022 PNH1024	PNH2016 PNH2018 PNH2024	PNH3019 PNH3023
Cutting edge	S0054505 S0102005 S0152510	S0152510 S0153510	S0152510 S0153510 S0203520	S0102005 S0153510
Coating	S/C3/CE	S/C3/CE	S/C3/CE	S/C3

Shape	ISO	ANSI	Tips forming	Cutting edges	ic	φd	S	r	la
 Conventional mini type	TCGW090202-3N	TCGW(1.8)(1.5)(0.5)-3N		□□ST22S	3	5.56	2.4	2.38	0.2
	090204-3N	(1.8)(1.5)1-3N							0.4
	090208-3N	(1.8)(1.5)2-3N							0.8
	TPGW090202-3N	TPGW(1.8)(1.5)(0.5)-3N		□□ST22S	3	5.56	2.8	2.38	0.2
 Standard type	TCGW090202-3N	TCGW(1.8)(1.5)(0.5)-3N		□□ST30S	3	5.56	2.4	2.38	0.2
	090204-3N	(1.8)(1.5)1-3N							0.4
	090208-3N	(1.8)(1.5)2-3N							0.8
	TPGW090202-3N	TPGW(1.8)(1.5)(0.5)-3N		□□ST30S	3	5.56	2.8	2.38	0.2
 Standard type	TPGW090202-3N	TPGW(1.8)(1.5)(0.5)-3N		□□ST30S	3	5.56	2.8	2.38	0.2
	090204-3N	(1.8)(1.5)1-3N							0.4
	090208-3N	(1.8)(1.5)2-3N							0.8

PCBN insert -Hardened Steel

Tipped Inserts

TC/TP	60°Square-Positive-With hole	H				
	PCBN Positive	Applications				
		Structure	SL	SL	SL	CB
		Material code	PNH0120 PNH0122 PNH0124	PNH1020 PNH1022 PNH1024	PNH2016 PNH2018 PNH2024	PNH3019 PNH3023
		Cutting edge	S0054505 S0102005 S0152510	S0152510 S0153510	S0152510 S0153510 S0203520	S0102005 S0153510
	Coating	S/C3/CE	S/C3/CE	S/C3/CE	S/C3	

Shape	ISO	ANSI	Tips forming		Cutting edges	ic	φd	S	r	la		
<p>Conventional mini type</p>	TCGW110302-3N	TCGW22(0.5)-3N		□□ST22S	3	6.35	2.8	3.18	0.2	2.2		
	110304-3N	221-3N		□□CBR422S	3				0.4			
	110308-3N	222-3N		□□CBR422S	3				0.8			
	TCGW110302-3N	TCGW22(0.5)-3N		□□ST22S	3				0.2			
	110304-3N	221-3N		□□CBR422S	3				0.4			
	110308-3N	222-3N		□□CBR422S	3				0.8			
	<p>Standard type</p>	TCGW110302-3N	TCGW22(0.5)-3N		□□ST30S	3	6.35	2.8	3.18		0.2	3.0
		110304-3N	221-3N		□□CBR430S	3					0.4	
		110308-3N	222-3N		□□CBR430S	3					0.8	
		TCGW110302-3N	TCGW22(0.5)-3N		□□ST30S	3					0.2	
		110304-3N	221-3N		□□CBR430S	3					0.4	
		110308-3N	222-3N		□□CBR430S	3					0.8	

PCBN insert -Hardened Steel





Tipped Inserts







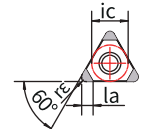
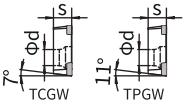

TC/TP	60°Square-Positive-With hole	H				
	PCBN Positive	Applications	○	◐	⊕	⊛
		Structure	SL	SL	SL	CB
		Material code	PNH0120 PNH0122 PNH0124	PNH1020 PNH1022 PNH1024	PNH2016 PNH2018 PNH2024	PNH3019 PNH3023
		Cutting edge	S0054505 S0102005 S0152510	S0152510 S0153510	S0152510 S0153510 S0203520	S0102005 S0153510
	Coating	S/C3/CE	S/C3/CE	S/C3/CE	S/C3	

Shape	ISO	ANSI	Tips forming		Cutting edges	ic	φd	S	r	la		
<p>Conventional mini type</p>	TCGW160304-3N	TCGW321-3N		□□ST22S	3	9.525	4.4	3.18	0.4	2.2		
	160308-3N	322-3N		□□CBR422S	3				0.8			
	160312-3N	323-3N		□□CBR422S	3				1.2			
	TCGW160304-3N	TCGW321-3N		□□CBR422S	3				0.4			
	160308-3N	322-3N		□□CBR422S	3				0.8			
	160312-3N	323-3N		□□CBR422S	3				1.2			
	<p>Standard type</p>	TCGW160304-3N	TCGW321-3N		□□ST30S	3	9.525	4.4	3.18		0.4	3.0
		160308-3N	322-3N		□□CBR430S	3					0.8	
		160312-3N	323-3N		□□CBR430S	3					1.2	
		TCGW160304-3N	TCGW321-3N		□□ST30S	3					0.4	
		160308-3N	322-3N		□□ST30S	3					0.8	
		160312-3N	323-3N		□□CBR430S	3					1.2	

PCBN insert -Hardened Steel

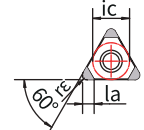
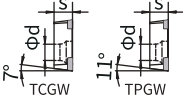
Tipped Inserts







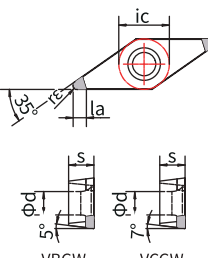

TC/TP	60°Square-Positive-With hole	H				
	PCBN Positive	Applications				
		Structure	SL	SL	SL	CB
		Material code	PNH0120 PNH0122 PNH0124	PNH1020 PNH1022 PNH1024	PNH2016 PNH2018 PNH2024	PNH3019 PNH3023
		Cutting edge	S0054505 S0102005 S0152510	S0152510 S0153510	S0152510 S0153510 S0203520	S0102005 S0153510
	Coating	S/C3/CE	S/C3/CE	S/C3/CE	S/C3	

Shape	ISO	ANSI	Tips forming		Cutting edges	ic	φd	S	r	la	
  Conventional mini type	TCGW160404-3N 160408-3N 160412-3N	TCGW331-3N 332-3N 333-3N		□□ST22S	3	9.525	4.4	4.76	0.4	2.2	
		TCGW160404-3N 160408-3N 160412-3N	TCGW331-3N 332-3N 333-3N		□□CBR422S				3		0.8
		TPGW160404-3N 160408-3N 160412-3N	TPGW331-3N 332-3N 333-3N		□□ST22S				3		1.2
		TPGW160404-3N 160408-3N 160412-3N	TPGW331-3N 332-3N 333-3N		□□CBR422S				3		0.4
									0.8		
									1.2		
									0.4		
									0.8		
  Standard type	TCGW160404-3N 160408-3N 160412-3N	TCGW331-3N 332-3N 333-3N		□□ST30S	3	9.525	4.4	4.76	0.4	3.0	
		TCGW160404-3N 160408-3N 160412-3N	TCGW331-3N 332-3N 333-3N		□□CBR430S				3		0.8
		TPGW160404-3N 160408-3N 160412-3N	TPGW331-3N 332-3N 333-3N		□□ST30S				3		1.2
		TPGW160404-3N 160408-3N 160412-3N	TPGW331-3N 332-3N 333-3N		□□CBR430S				3		0.4
									0.8		
									1.2		
									0.4		
									0.8		

PCBN insert -Hardened Steel

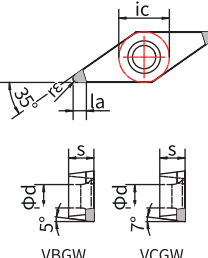
Tipped Inserts

VB/VC	35°rhombic-Positive-With hole	H				
	PCBN Positive	Applications	○	◐	⊕	⊛
		Structure	SL	SL	SL	CB
		Material code	PNH0120 PNH0122 PNH0124	PNH1020 PNH1022 PNH1024	PNH2016 PNH2018 PNH2024	PNH3019 PNH3023
		Cutting edge	S0054505 S0102005 S0152510	S0152510 S0153510	S0152510 S0153510 S0203520	S0102005 S0153510
	Coating	S/C3/CE	S/C3/CE	S/C3/CE	S/C3	

Shape	ISO	ANSI	Tips forming		Cutting edges	ic	φd	S	r	la			
 <p>Conventional mini type</p>	VBGW110302-2N	VBGW22(0.5)-2N		□□ST22S	2	6.35	2.8	3.18	0.2	2.2			
	110304-2N	221-2N											
	110308-2N	222-2N											
	VBGW110302-2N	VBGW22(0.5)-2N		□□CBR422S	2	6.35	2.8	3.18	0.2		2.2		
	110304-2N	221-2N											
	110308-2N	222-2N											
	VCGW110302-2N	VCGW22(0.5)-2N		□□ST22S	2	6.35	2.8	3.18	0.2			2.2	
	110304-2N	221-2N											
	110308-2N	222-2N											
	VCGW110302-2N	VCGW22(0.5)-2N		□□CBR422S	2	6.35	2.8	3.18	0.2				2.2
	110304-2N	221-2N											
	110308-2N	222-2N											
 <p>Standard type</p>	VBGW110302-2N	VBGW22(0.5)-2N		□□ST30S	2	6.35	2.8	3.18	0.2	3.0			
	110304-2N	221-2N											
	110308-2N	222-2N											
	VBGW110302-2N	VBGW22(0.5)-2N		□□CBR430S	2	6.35	2.8	3.18	0.2		3.0		
	110304-2N	221-2N											
	110308-2N	222-2N											
	VCGW110302-2N	VCGW22(0.5)-2N		□□ST30S	2	6.35	2.8	3.18	0.2			3.0	
	110304-2N	221-2N											
	110308-2N	222-2N											
	VCGW110302-2N	VCGW22(0.5)-2N		□□CBR430S	2	6.35	2.8	3.18	0.2				3.0
	110304-2N	221-2N											
	110308-2N	222-2N											

PCBN insert -Hardened Steel

Tipped Inserts

VB/VC	35°rhombic-Positive-With hole
	PCBN Positive

H				
Applications				
Structure	SL	SL	SL	CB
Material code	PNH0120 PNH0122 PNH0124	PNH1020 PNH1022 PNH1024	PNH2016 PNH2018 PNH2024	PNH3019 PNH3023
Cutting edge	S0054505 S0102005 S0152510	S0152510 S0153510	S0152510 S0153510 S0203520	S0102005 S0153510
Coating	S/C3/CE	S/C3/CE	S/C3/CE	S/C3

Shape	ISO	ANSI	Tips forming		Cutting edges	ic	φd	S	r	la
<p>Conventional mini type</p>	VBGW160404-2N	VBGW331-2N		□□ST22S	2	9.525	4.4	4.76	0.4	2.2
	160408-2N	332-2N							0.8	
	160412-2N	333-2N							1.2	
	VBGW160404-2N	VBGW331-2N		□□CBR422S	2	9.525	4.4	4.76	0.4	
	160408-2N	332-2N							0.8	
	160412-2N	333-2N							1.2	
	VCGW160404-2N	VCGW331-2N		□□ST22S	2	9.525	4.4	4.76	0.4	
	160408-2N	332-2N							0.8	
160412-2N	333-2N	1.2								
VCGW160404-2N	VCGW331-2N		□□CBR422S	2	9.525	4.4	4.76	0.4		
160408-2N	332-2N							0.8		
160412-2N	333-2N							1.2		
<p>Standard type</p>	VBGW160404-2N	VBGW331-2N		□□ST30S	2	9.525	4.4	4.76	0.4	3.0
	160408-2N	332-2N							0.8	
	160412-2N	333-2N							1.2	
	VBGW160404-2N	VBGW331-2N		□□CBR430S	2	9.525	4.4	4.76	0.4	
	160408-2N	332-2N							0.8	
	160412-2N	333-2N							1.2	
	VCGW160404-2N	VCGW331-2N		□□ST30S	2	9.525	4.4	4.76	0.4	
	160408-2N	332-2N							0.8	
160412-2N	333-2N	1.2								
VCGW160404-2N	VCGW331-2N		□□CBR430S	2	9.525	4.4	4.76	0.4		
160408-2N	332-2N							0.8		
160412-2N	333-2N							1.2		
<p>long cutting edge</p>	VBGW160404-2N	VBGW331-2N		□□ST40S	2	9.525	4.4	4.76	0.4	4.0
	160408-2N	332-2N							0.8	
	160412-2N	333-2N							1.2	
	VBGW160416-2N	334-2N		□□CBR640S	2	9.525	4.4	4.76	1.6	
	160408-2N	332-2N							0.8	
	160412-2N	333-2N							1.2	
	VCGW160404-2N	VCGW331-2N		□□ST40S	2	9.525	4.4	4.76	0.4	
	160408-2N	332-2N							0.8	
160412-2N	333-2N	1.2								
VCGW160416-2N	VCGW331-2N		□□CBR640S	2	9.525	4.4	4.76	1.6		
160408-2N	332-2N							0.8		
160412-2N	333-2N							1.2		

PCBN insert -Hardened Steel

Tipped Inserts

CN	80° rhombic-Negative-Solid
	PCBN Negative

H	
Applications	
Structure	SS
Material code	PNH2026 PNH2028
Cutting edge	S0102010 S0202020
Coating	S/C3/CE

Shape	ISO	ANSI	Tips forming		Cutting edges	ic	φd	S	r	la
	CNGN090304-4N	CNGN321-4N		SSST90S	4	9.525	—	3.18	0.4	9
	090308-4N	322-4N							0.8	
	090312-4N	323-4N							1.2	
	CNGN090304-4N	CNGN321-4N		SSWGR90S	4				0.4	
	090308-4N	322-4N							0.8	
	090312-4N	323-4N							1.2	
	CNGN090304-4N	CNGN321-4N		SSCBR490S	4				0.4	
	090308-4N	322-4N							0.8	
	090312-4N	323-4N							1.2	
	CNGN090404-4N	CNGN331-4N		SSST90S	4	9.525	—	4.76	0.4	9
	090408-4N	332-4N							0.8	
	090412-4N	333-4N							1.2	
	CNGN090404-4N	CNGN331-4N		SSWGR90S	4				0.4	
	090408-4N	332-4N							0.8	
	090412-4N	333-4N							1.2	
	CNGN090404-4N	CNGN331-4N		SSCBR490S	4				0.4	
	090408-4N	332-4N							0.8	
	090412-4N	333-4N							1.2	

CN	80° rhombic-Negative-With hole
	PCBN Negative

H				
Applications				
Structure	SL	SL	SL	CB
Material code	PNH0120 PNH0122 PNH0124	PNH1020 PNH1022 PNH1024	PNH2016 PNH2018 PNH2024	PNH3019 PNH3023
Cutting edge	S0054505 S0102005 S0152510	S0152510 S0153510	S0152510 S0153510 S0203520	S0102005 S0153510
Coating	S/C3/CE	S/C3/CE	S/C3/CE	S/C3







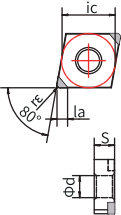

Shape	ISO	ANSI	Tips forming		Cutting edges	ic	φd	S	r	la
<p>Conventional mini type</p>	CNGA120404-2N	CNGA431-2N		□□ST22S	2	12.7	5.16	5.16	0.4	2.2
	120408-2N	432-2N							0.8	
	120412-2N	433-2N							1.2	
	CNGA120404-2N	CNGA431-2N		□□WGR22S	2				0.4	
	120408-2N	432-2N							0.8	
	120412-2N	433-2N							1.2	
	CNGA120404-2N	CNGA431-2N		□□CBR422S	2				0.4	
	120408-2N	432-2N							0.8	
	120412-2N	433-2N							1.2	
<p>Standard type</p>	CNGA120404-2N	CNGA431-2N		□□ST30S	2	12.7	5.16	5.16	0.4	3.0
	120408-2N	432-2N							0.8	
	120412-2N	433-2N							1.2	
	CNGA120404-2N	CNGA431-2N		□□WGR30S	2				0.4	
	120408-2N	432-2N							0.8	
	120412-2N	433-2N							1.2	
	CNGA120404-2N	CNGA431-2N		□□CBR430S	2				0.4	
	120408-2N	432-2N							0.8	
	120412-2N	433-2N							1.2	

PCBN insert -Hardened Steel

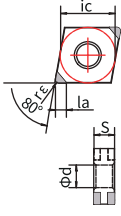
Tipped Inserts

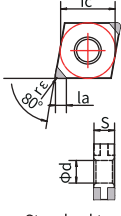
CN	80° rhombic-Negative-With hole
	PCBN Negative

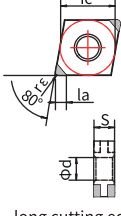
H				
Applications	○	☉	⊕	⊗
Structure	SL	SL	SL	CB
Material code	PNH0120 PNH0122 PNH0124	PNH1020 PNH1022 PNH1024	PNH2016 PNH2018 PNH2024	PNH3019 PNH3023
Cutting edge	S0054505 S0102005 S0152510	S0152510 S0153510	S0152510 S0153510 S0203520	S0102005 S0153510
Coating	S/C3/CE	S/C3/CE	S/C3/CE	S/C3











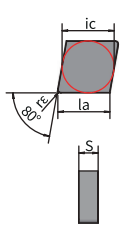



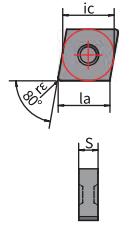

Shape	ISO	ANSI	Tips forming		Cutting edges	ic	φd	S	r	la					
 <p>long cutting edge</p>	CNGA120408-2N	CNGA432-2N		□□ST40S	2	12.7	5.16	4.76	0.8	4.0					
	120412-2N	433-2N		□□WGR40S					1.2						
	120416-2N	434-2N		□□CBR640S					1.6						
	CNGA120408-2N	CNGA432-2N		□□WGR40S	2				0.8						
	120412-2N	433-2N		□□CBR640S					1.2						
	120416-2N	434-2N		□□CBR640S					1.6						
	 <p>Conventional mini type</p>	CNGA120404-4N	CNGA431-4N		□□ST22S				4		12.7	5.16	4.76	0.4	2.2
		120408-4N	432-4N		□□WGR22S									0.8	
		120412-4N	433-4N		□□CBR422S									1.2	
CNGA120404-4N		CNGA431-4N		□□WGR22S	4	0.4									
120408-4N		432-4N		□□CBR422S		0.8									
120412-4N		433-4N		□□CBR422S		1.2									
 <p>Standard type</p>		CNGA120404-4N	CNGA431-4N		□□ST30S	4	12.7	5.16	4.76	0.4				3.0	
		120408-4N	432-4N		□□WGR30S					0.8					
		120412-4N	433-4N		□□CBR430S					1.2					
	CNGA120404-4N	CNGA431-4N		□□WGR30S	4	0.4									
	120408-4N	432-4N		□□CBR430S		0.8									
	120412-4N	433-4N		□□CBR430S		1.2									
	 <p>long cutting edge</p>	CNGA120408-4N	CNGA432-4N		□□ST40S	4				12.7	5.16	4.76	0.8		4.0
		120412-4N	433-4N		□□WGR40S								1.2		
		120416-4N	434-4N		□□CBR640S								1.6		
CNGA120408-4N		CNGA432-4N		□□WGR40S	4	0.8									
120412-4N		433-4N		□□CBR640S		1.2									
120416-4N		434-4N		□□CBR640S		1.6									

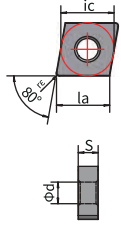
PCBN insert -Hardened Steel

Tipped Inserts

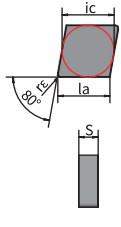
CN	80° rhombic-Negative-Solid
	PCBN Negative

H	
Applications	
Structure	SS
Material code	PNH2026 PNH2028
Cutting edge	S0102010 S0202020
Coating	S/C3/CE

Shape	ISO	ANSI	Tips forming		Cutting edges	ic	φd	S	r	la
	CNGN120408-4N	CNGN432-4N		SSST120S	4	12.7	—	4.76	0.8	12
	120412-4N	433-4N							1.2	
	120416-4N	434-4N							1.6	
	CNGN120408-4N	CNGN432-4N		SSWGR120S	4				0.8	
	120412-4N	433-4N							1.2	
	120416-4N	434-4N							1.6	
	CNGN120408-4N	CNGN432-4N		SSCBR6120S	4				0.8	
	120412-4N	433-4N							1.2	
	120416-4N	434-4N							1.6	
	CNGX120408-4N	CNGX432-4N		SSST120S	4	12.7	—	4.76	0.8	12
	120412-4N	433-4N							1.2	
	120416-4N	434-4N							1.6	
	CNGX120408-4N	CNGX432-4N		SSWGR120S	4				0.8	
	120412-4N	433-4N							1.2	
	120416-4N	434-4N							1.6	
	CNGX120408-4N	CNGX432-4N		SSCBR6120S	4				0.8	
	120412-4N	433-4N							1.2	
	120416-4N	434-4N							1.6	
	CNGA120408-4N	CNGA432-4N		SSST120S	4	12.7	5.16	4.76	0.8	12
	120412-4N	433-4N							1.2	
	120416-4N	434-4N							1.6	
	CNGA120408-4N	CNGA432-4N		SSWGR120S	4				0.8	
	120412-4N	433-4N							1.2	
	120416-4N	434-4N							1.6	
	CNGA120408-4N	CNGA432-4N		SSCBR6120S	4				0.8	
	120412-4N	433-4N							1.2	
	120416-4N	434-4N							1.6	
	CNGN120608-4N	CNGN442-4N		SSST120S	4	12.7	—	6.35	0.8	12
	120612-4N	443-4N							1.2	
	120616-4N	444-4N							1.6	
	CNGN120608-4N	CNGN442-4N		SSWGR120S	4				0.8	
	120612-4N	443-4N							1.2	
	120616-4N	444-4N							1.6	
	CNGN120608-4N	CNGN442-4N		SSCBR6120S	4				0.8	
	120612-4N	443-4N							1.2	
	120616-4N	444-4N							1.6	

PCBN insert -Hardened Steel

Tipped Inserts

CN	80° rhombic-Negative-Solid
	PCBN Negative

H	
Applications	
Structure	SS
Material code	PNH2026 PNH2028
Cutting edge	S0102010 S0202020
Coating	S/C3/CE

Shape	ISO	ANSI	Tips forming		Cutting edges	ic	φd	S	r	la
	CNGX120608-4N	CNGX442-4N		SSST120S	4	12.7	—	6.35	0.8	12
	120612-4N	443-4N							1.2	
	120616-4N	444-4N							1.6	
	CNGX120608-4N	CNGX442-4N		SSWGR120S	4				0.8	
	120612-4N	443-4N							1.2	
	120616-4N	444-4N							1.6	
	CNGX120608-4N	CNGX442-4N		SSCBR6120S	4				0.8	
	120612-4N	443-4N							1.2	
	120616-4N	444-4N							1.6	
	CNGN120708-4N	CNGN452-4N		SSST120S	4	12.7	—	7.94	0.8	12
	120712-4N	453-4N							1.2	
	120716-4N	454-4N							1.6	
	CNGN120708-4N	CNGN452-4N		SSWGR120S	4				0.8	
	120712-4N	453-4N							1.2	
	120716-4N	454-4N							1.6	
	CNGN120708-4N	CNGN452-4N		SSCBR6120S	4				0.8	
	120712-4N	453-4N							1.2	
	120716-4N	454-4N							1.6	
	CNGX120708-4N	CNGX452-4N		SSST120S	4	12.7	—	7.94	0.8	12
	120712-4N	453-4N							1.2	
	120716-4N	454-4N							1.6	
	CNGX120708-4N	CNGX452-4N		SSWGR120S	4				0.8	
	120712-4N	453-4N							1.2	
	120716-4N	454-4N							1.6	
	CNGX120708-4N	CNGX452-4N		SSCBR6120S	4				0.8	
	120712-4N	453-4N							1.2	
	120716-4N	454-4N							1.6	

CN	80° rhombic-Negative-Solid
	PCBN Negative

H				
Applications				
Structure	SWU	SWU	SWU	
Material code	PNH0120 PNH0124	PNH2016 PNH2024	PNH3020	
Cutting edge	S0102010		S0202020	
Coating	S/C3/CE	S/C3/CE	S/C3	



Shape	ISO	ANSI	Tips forming		Cutting edges	ic	φd	S	r	la
	CNGA120408-4N	CNGA432-4N		SWUST25S	4	12.7	5.16	4.76	0.8	2.5
	120412-4N	433-4N							1.2	
	120416-4N	434-4N							1.6	
	CNGA120408-4N	CNGA432-4N		SWUWGR25S	4				0.8	
	120412-4N	433-4N							1.2	
	120416-4N	434-4N							1.6	
	CNGA120408-4N	CNGA432-4N		SWUCBR425S	4				0.8	
	120412-4N	433-4N							1.2	
	120416-4N	434-4N							1.6	

PCBN insert -Hardened Steel



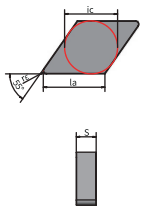

Tipped Inserts











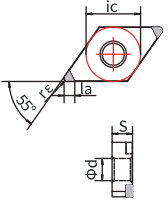





DN	55°rhombic-Negative-Solid
	PCBN Negative

H	
Applications	
Structure	SS
Material code	PNH2026 PNH2028
Cutting edge	S0102010 S0202020
Coating	S/C3/CE

Shape	ISO	ANSI	Tips forming		Cutting edges	ic	φd	S	r	la
	DNGN110404-4N	DNGN331-4N		SSST110S	4	9.525	—	4.76	0.4	11
	110408-4N	332-4N							0.8	
	110412-4N	333-4N							1.2	
	DNGN110404-4N	DNGN331-4N		SSCBR4110S	4	9.525	—	4.76	0.4	
	110408-4N	332-4N							0.8	
	110412-4N	333-4N							1.2	

DN	55°rhombic-Negative-With hole
	PCBN Negative

H				
Applications				
Structure	SL	SL	SL	CB
Material code	PNH0120 PNH0122 PNH0124	PNH1020 PNH1022 PNH1024	PNH2016 PNH2018 PNH2024	PNH3019 PNH3023
Cutting edge	S0054505 S0102005 S0152510	S0152510 S0153510	S0152510 S0153510 S0203520	S0102005 S0153510
Coating	S/C3/CE	S/C3/CE	S/C3/CE	S/C3

Shape	ISO	ANSI	Tips forming		Cutting edges	ic	φd	S	r	la						
 <p>Conventional mini type</p>	DNGA150404-2N	DNGA431-2N		□□ST22S	2	12.7	5.16	4.76	0.4	2.2						
	150408-2N	432-2N									□□WGR22S (107.5°)	2	12.7	5.16	4.76	0.8
	150412-2N	433-2N														
	DNGA150404-2N	DNGA431-2N		□□ST30S	2	12.7	5.16	4.76	0.4							
	150408-2N	432-2N									□□WGR30S (107.5°)	2	12.7	5.16	4.76	
	150412-2N	433-2N														
	DNGA150404-2N	DNGA431-2N		□□ST40S	2	12.7	5.16	4.76	0.4							
	150408-2N	432-2N									□□WGR40S (107.5°)	2	12.7	5.16	4.76	
	150412-2N	433-2N														
DNGA150408-2N	DNGA432-2N		□□ST40S	2	12.7	5.16	4.76	0.8								
150412-2N	433-2N								□□WGR40S (107.5°)	2	12.7	5.16	4.76	1.2		
150416-2N	434-2N														□□CBR640S	2
DNGA150408-2N	DNGA432-2N		□□WGR40S (107.5°)	2	12.7	5.16	4.76	0.8								
150412-2N	433-2N								□□CBR640S	2	12.7	5.16	4.76			
150416-2N	434-2N														□□CBR640S	2

PCBN insert -Hardened Steel

Tipped Inserts

DN	55°rhombic-Negative-with hole
	PCBN Negative

H				
Applications				
Structure	SL	SL	SL	CB
Material code	PNH0120 PNH0122 PNH0124	PNH1020 PNH1022 PNH1024	PNH2016 PNH2018 PNH2024	PNH3019 PNH3023
Cutting edge	S0054505 S0102005 S0152510	S0152510 S0153510	S0152510 S0153510 S0203520	S0102005 S0153510
Coating	S/C3/CE	S/C3/CE	S/C3/CE	S/C3

Shape	ISO	ANSI	Tips forming		Cutting edges	ic	φd	S	r	la
 Conventional mini type	DNGA150404-4N	DNGA431-4N		□□ST22S	4	12.7	5.16	4.76	0.4	2.2
	150408-4N	432-4N		□□WGR22S (107.5°)	4				0.8	
	150412-4N	433-4N		□□CBR422S	4				1.2	
	DNGA150404-4N	DNGA431-4N		□□WGR22S (107.5°)	4				0.4	
	150408-4N	432-4N		□□WGR22S (107.5°)	4				0.8	
	150412-4N	433-4N		□□WGR22S (107.5°)	4				1.2	
	DNGA150404-4N	DNGA431-4N		□□CBR422S	4				0.4	
	150408-4N	432-4N		□□CBR422S	4				0.8	
	150412-4N	433-4N		□□CBR422S	4				1.2	
 Standard type	DNGA150404-4N	DNGA431-4N		□□ST30S	4	12.7	5.16	4.76	0.4	3.0
	150408-4N	432-4N		□□WGR30S (107.5°)	4				0.8	
	150412-4N	433-4N		□□CBR430S	4				1.2	
	DNGA150404-4N	DNGA431-4N		□□WGR30S (107.5°)	4				0.4	
	150408-4N	432-4N		□□WGR30S (107.5°)	4				0.8	
	150412-4N	433-4N		□□WGR30S (107.5°)	4				1.2	
	DNGA150404-4N	DNGA431-4N		□□CBR430S	4				0.4	
	150408-4N	432-4N		□□CBR430S	4				0.8	
	150412-4N	433-4N		□□CBR430S	4				1.2	
 long cutting edge	DNGA150408-4N	DNGA432-4N		□□ST40S	4	12.7	5.16	4.76	0.8	4.0
	150412-4N	433-4N		□□WGR40S (107.5°)	4				1.2	
	150416-4N	434-4N		□□CBR640S	4				1.6	
	DNGA150408-4N	DNGA432-4N		□□WGR40S (107.5°)	4				0.8	
	150412-4N	433-4N		□□WGR40S (107.5°)	4				1.2	
	150416-4N	434-4N		□□WGR40S (107.5°)	4				1.6	
	DNGA150408-4N	DNGA432-4N		□□CBR640S	4				0.8	
	150412-4N	433-4N		□□CBR640S	4				1.2	
	150416-4N	434-4N		□□CBR640S	4				1.6	

PCBN insert -Hardened Steel

Tipped Inserts

DN	55°rhombic-Negative-Solid
	PCBN Negative

H	
Applications	
Structure	SS
Material code	PNH2028
Cutting edge	S0102010 S0202020
Coating	S/C3/CE

Shape	ISO	ANSI	Tips forming		Cutting edges	ic	φd	S	r	la
	DNGN150408-4N	DNGN432-4N		SSST150S	4	12.7	—	4.76	0.8	15
	150412-4N	433-4N							1.2	
	150416-4N	434-4N							1.6	
	DNGN150408-4N	DNGN432-4N		SSCBR6150S	4	12.7	—	4.76	0.8	15
	150412-4N	433-4N							1.2	
	150416-4N	434-4N							1.6	
	DNGX150408-4N	DNGX432-4N		SSST150S	4	12.7	—	4.76	0.8	15
	150412-4N	433-4N							1.2	
	150416-4N	434-4N							1.6	
	DNGX150408-4N	DNGX432-4N		SSCBR6150S	4	12.7	—	4.76	0.8	15
	150412-4N	433-4N							1.2	
	150416-4N	434-4N							1.6	
	DNGA150408-4N	DNGA432-4N		SSST150S	4	12.7	5.16	4.76	0.8	15
	150412-4N	433-4N							1.2	
	150416-4N	434-4N							1.6	
	DNGA150408-4N	DNGA432-4N		SSCBR6150S	4	12.7	5.16	4.76	0.8	15
	150412-4N	433-4N							1.2	
	150416-4N	434-4N							1.6	

DN	55°rhombic-Negative-full length
	PCBN Negative

H			
Applications			
Structure	SWU	SWU	
Material code	PNH0120 PNH0124	PNH2016 PNH2024	
Cutting edge	S0102010	S0202020	
Coating	S/C3/CE	S/C3/CE	

Shape	ISO	ANSI	Tips forming		Cutting edges	ic	φd	S	r	la
	DNGA150408-4N	DNGA432-4N		SWUST25S	4	12.7	5.16	4.76	0.8	2.5
	150412-4N	433-4N							1.2	
	150416-4N	434-4N							1.6	
	DNGA150408-4N	DNGA432-4N		SWUCBR425S	4	12.7	5.16	4.76	0.8	2.5
	150412-4N	433-4N							1.2	
	150416-4N	434-4N							1.6	

PCBN insert -Hardened Steel

Tipped Inserts

DN	55°rhombic-Negative-with hole
	PCBN Negative

H				
Applications				
Structure	SL	SL	SL	CB
Material code	PNH0120 PNH0122 PNH0124	PNH1020 PNH1022 PNH1024	PNH2016 PNH2018 PNH2024	PNH3019 PNH3023
Cutting edge	S0054505 S0102005 S0152510	S0152510 S0153510	S0152510 S0153510 S0203520	S0102005 S0153510
Coating	S/C3/CE	S/C3/CE	S/C3/CE	S/C3



Shape	ISO	ANSI	Tips forming		Cutting edges	ic	φd	S	r	la
 Conventional mini type	DNGA150604-2N	DNGA441-2N		□□ST22S	2	12.7	5.16	6.35	0.4	2.2
	150608-2N	442-2N							0.8	
	150612-2N	443-2N							1.2	
	DNGA150604-2N	DNGA441-2N		□□WGR22S (107.5°)	2				0.4	
	150608-2N	442-2N							0.8	
	150612-2N	443-2N							1.2	
	DNGA150604-2N	DNGA441-2N		□□CBR422S	2				0.4	
	150608-2N	442-2N							0.8	
	150612-2N	443-2N							1.2	
 Standard type	DNGA150604-2N	DNGA441-2N		□□ST30S	2	12.7	5.16	6.35	0.4	3.0
	150608-2N	442-2N							0.8	
	150612-2N	443-2N							1.2	
	DNGA150604-2N	DNGA441-2N		□□WGR30S (107.5°)	2				0.4	
	150608-2N	442-2N							0.8	
	150612-2N	443-2N							1.2	
	DNGA150604-2N	DNGA441-2N		□□CBR430S	2				0.4	
	150608-2N	442-2N							0.8	
	150612-2N	443-2N							1.2	
 long cutting edge	DNGA150608-2N	DNGA442-2N		□□ST40S	2	12.7	5.16	6.35	0.8	4.0
	150612-2N	443-2N							1.2	
	150616-2N	444-2N							1.6	
	DNGA150608-2N	DNGA442-2N		□□WGR40S (107.5°)	2				0.8	
	150612-2N	443-2N							1.2	
	150616-2N	444-2N							1.6	
	DNGA150608-2N	DNGA442-2N		□□CBR640S	2				0.8	
	150612-2N	443-2N							1.2	
	150616-2N	444-2N							1.6	
 Conventional mini type	DNGA150604-4N	DNGA441-4N		□□ST22S	4	12.7	5.16	6.35	0.4	2.2
	150608-4N	442-4N							0.8	
	150612-4N	443-4N							1.2	
	DNGA150604-4N	DNGA441-4N		□□WGR22S (107.5°)	4				0.4	
	150608-4N	442-4N							0.8	
	150612-4N	443-4N							1.2	
	DNGA150604-4N	DNGA441-4N		□□CBR422S	4				0.4	
	150608-4N	442-4N							0.8	
	150612-4N	443-4N							1.2	
 Standard type	DNGA150604-4N	DNGA441-4N		□□ST30S	4	12.7	5.16	6.35	0.4	3.0
	150608-4N	442-4N							0.8	
	150612-4N	443-4N							1.2	
	DNGA150604-4N	DNGA441-4N		□□WGR30S (107.5°)	4				0.4	
	150608-4N	442-4N							0.8	
	150612-4N	443-4N							1.2	
	DNGA150604-4N	DNGA441-4N		□□CBR430S	4				0.4	
	150608-4N	442-4N							0.8	
	150612-4N	443-4N							1.2	
 long cutting edge	DNGA150608-4N	DNGA442-4N		□□ST40S	4	12.7	5.16	6.35	0.8	4.0
	150612-4N	443-4N							1.2	
	150616-4N	444-4N							1.6	
	DNGA150608-4N	DNGA442-4N		□□WGR40S (107.5°)	4				0.8	
	150612-4N	443-4N							1.2	
	150616-4N	444-4N							1.6	
	DNGA150608-4N	DNGA442-4N		□□CBR640S	4				0.8	
	150612-4N	443-4N							1.2	
	150616-4N	444-4N							1.6	

PCBN insert -Hardened Steel



Tipped Inserts

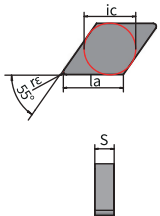

DN	55°rhombic-Negative-Solid
	PCBN Negative

H	
Applications	
Structure	SS
Material code	PNH2028
Cutting edge	S0102010 S0202020
Coating	S/C3/CE

Shape	ISO	ANSI	Tips forming		Cutting edges	ic	φd	S	r	la
	DNGN150608-4N	DNGN442-4N		SSST150S	4	12.7	—	6.35	0.8	15
	150612-4N	443-4N							1.2	
	150616-4N	444-4N							1.6	
	DNGN150608-4N	DNGN442-4N		SSCBR6150S	4	12.7	—	6.35	0.8	
	150612-4N	443-4N							1.2	
	150616-4N	444-4N							1.6	

DN	55°rhombic-Negative-Full length
	PCBN Negative

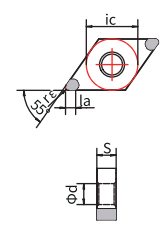
H			
Applications			
Structure	SWU	SWU	
Material code	PNH0120 PNH0124	PNH2016 PNH2024	
Cutting edge	S0102010 S0202020		
Coating	S/C3/CE		S/C3/CE







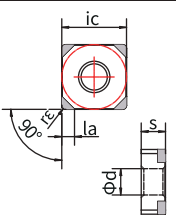

Shape	ISO	ANSI	Tips forming		Cutting edges	ic	φd	S	r	la
	DNGA150608-4N	DNGA442-4N		SWUST25S	4	12.7	5.16	6.35	0.8	2.5
	150612-4N	443-4N							1.2	
	150616-4N	444-4N							1.6	
	DNGA150608-4N	DNGA442-4N		SWUCBR425S	4	12.7	5.16	6.35	0.8	
	150612-4N	443-4N							1.2	
	150616-4N	444-4N							1.6	

PCBN insert -Hardened Steel

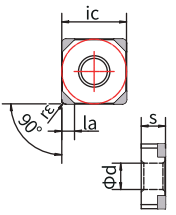
Tipped Inserts

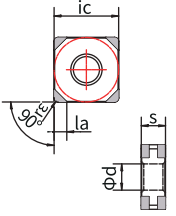
SN	90° square-Negative-With hole
	PCBN Negative

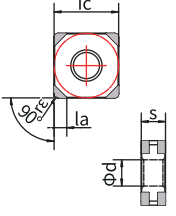
H				
Applications				
Structure	SL	SL	SL	CB
Material code	PNH0120 PNH0122 PNH0124	PNH1020 PNH1022 PNH1024	PNH2016 PNH2018 PNH2024	PNH3019 PNH3023
Cutting edge	S0054505 S0102005 S0152510	S0152510 S0153510	S0152510 S0153510 S0203520	S0102005 S0153510
Coating	S/C3/CE	S/C3/CE	S/C3/CE	S/C3

Shape	ISO	ANSI	Tips forming		Cutting edges	ic	ød	S	r	la
 Conventional mini type	SNGA090304-4N	SNGA321-4N		□□ST22S	4	9.525	3.81	3.18	0.4	2.2
	090308-4N	322-4N							0.8	
	090312-4N	323-4N							1.2	
	SNGA090304-4N	SNGA321-4N		□□CBR422S	4				0.4	
	090308-4N	322-4N							0.8	
	090312-4N	323-4N							1.2	
 Standard type	SNGA090304-4N	SNGA321-4N		□□ST30S	4	9.525	3.81	3.18	0.4	3.0
	090308-4N	322-4N							0.8	
	090312-4N	323-4N							1.2	
	SNGA090304-4N	SNGA321-4N		□□CBR430S	4				0.4	
	090308-4N	322-4N							0.8	
	090312-4N	323-4N							1.2	
 Conventional mini type	SNGA090304-8N	SNGA321-8N		□□ST22S	8	9.525	3.81	3.18	0.4	2.2
	090308-8N	322-8N							0.8	
	090312-8N	323-8N							1.2	
	SNGA090304-8N	SNGA321-8N		□□CBR422S	8				0.4	
	090308-8N	322-8N							0.8	
	090312-8N	323-8N							1.2	
 Standard type	SNGA090304-8N	SNGA321-8N		□□ST30S	8	9.525	3.81	3.18	0.4	3.0
	090308-8N	322-8N							0.8	
	090312-8N	323-8N							1.2	
	SNGA090304-8N	SNGA321-8N		□□CBR430S	8				0.4	
	090308-8N	322-8N							0.8	
	090312-8N	323-8N							1.2	

PCBN insert -Hardened Steel

Tipped Inserts

SN	90° square-Negative-With hole
	PCBN Negative

H				
Applications				
Structure	SL	SL	SL	CB
Material code	PNH0120 PNH0122 PNH0124	PNH1020 PNH1022 PNH1024	PNH2016 PNH2018 PNH2024	PNH3019 PNH3023
Cutting edge	S0054505 S0102005 S0152510	S0152510 S0153510	S0152510 S0153510 S0203520	S0102005 S0153510
Coating	S/C3/CE	S/C3/CE	S/C3/CE	S/C3







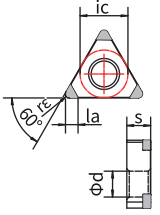

Shape	ISO	ANSI	Tips forming		Cutting edges	ic	φd	S	r	la
 Conventional mini type	SNGA120404-4N	SNGA431-4N		□□ST22S	4	12.7	5.16	4.76	0.4	2.2
	120408-4N	432-4N							0.8	
	120412-4N	433-4N	1.2							
	SNGA120404-4N	SNGA431-4N		□□CBR422S	4				0.4	
120408-4N	432-4N	0.8								
120412-4N	433-4N	1.2								
 Standard type	SNGA120404-4N	SNGA431-4N		□□ST30S	4	12.7	5.16	4.76	0.4	3.0
	120408-4N	432-4N							0.8	
	120412-4N	433-4N	1.2							
	SNGA120404-4N	SNGA431-4N		□□CBR430S	4				0.4	
120408-4N	432-4N	0.8								
120412-4N	433-4N	1.2								
 long cutting edge	SNGA120408-4N	SNGA432-4N		□□ST40S	4	12.7	5.16	4.76	0.8	4.0
	120412-4N	433-4N							1.2	
	120416-4N	434-4N	1.6							
	SNGA120408-4N	SNGA432-4N		□□CBR640S	4				0.8	
120412-4N	433-4N	1.2								
120416-4N	434-4N	1.6								
 Conventional mini type	SNGA120404-8N	SNGA431-8N		□□ST22S	8	12.7	5.16	4.76	0.4	2.2
	120408-8N	432-8N							0.8	
	120412-8N	433-8N	1.2							
	SNGA120404-8N	SNGA431-8N		□□CBR422S	8				0.4	
120408-8N	432-8N	0.8								
120412-8N	433-8N	1.2								
 Standard type	SNGA120404-8N	SNGA431-8N		□□ST30S	8	12.7	5.16	4.76	0.4	3.0
	120408-8N	432-8N							0.8	
	120412-8N	433-8N	1.2							
	SNGA120404-8N	SNGA431-8N		□□CBR430S	8				0.4	
120408-8N	432-8N	0.8								
120412-8N	433-8N	1.2								
 long cutting edge	SNGA120408-8N	SNGA432-8N		□□ST40S	8	12.7	5.16	4.76	0.8	4.0
	120412-8N	433-8N							1.2	
	120416-8N	434-8N	1.6							
	SNGA120408-8N	SNGA432-8N		□□CBR640S	8				0.8	
120412-8N	433-8N	1.2								
120416-8N	434-8N	1.6								

PCBN insert -Hardened Steel

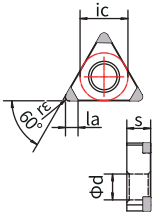
Tipped Inserts

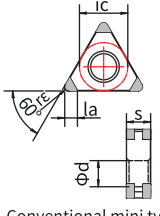
TN	60°Square-Negative-With hole
	PCBN Negative

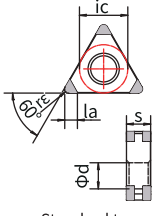
H				
Applications	○	⦿	⊕	⊛
Structure	SL	SL	SL	CB
Material code	PNH0120 PNH0122 PNH0124	PNH1020 PNH1022 PNH1024	PNH2016 PNH2018 PNH2024	PNH3019 PNH3023
Cutting edge	S0054505 S0102005 S0152510	S0152510 S0153510	S0152510 S0153510 S0203520	S0102005 S0153510
Coating	S/C3/CE	S/C3/CE	S/C3/CE	S/C3









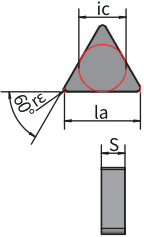

Shape	ISO	ANSI	Tips forming		Cutting edges	ic	φd	S	r	la
 Conventional mini type	TNGA160404-3N	TNGA331-3N		□□ST22S	3	9.525	3.81	4.76	0.4	2.2
	160408-3N	332-3N							0.8	
	160412-3N	333-3N							1.2	
	TNGA160404-3N	TNGA331-3N		□□CBR422S	3	0.4				
	160408-3N	332-3N				0.8				
	160412-3N	333-3N				1.2				
 Standard type	TNGA160404-3N	TNGA331-3N		□□ST30S	3	9.525	3.81	4.76	0.4	3.0
	160408-3N	332-3N							0.8	
	160412-3N	333-3N							1.2	
	TNGA160404-3N	TNGA331-3N		□□CBR430S	3	0.4				
	160408-3N	332-3N				0.8				
	160412-3N	333-3N				1.2				
 Conventional mini type	TNGA160404-6N	TNGA331-6N		□□ST22S	6	9.525	3.81	4.76	0.4	2.2
	160408-6N	332-6N							0.8	
	160412-6N	333-6N							1.2	
	TNGA160404-6N	TNGA331-6N		□□CBR422S	6	0.4				
	160408-6N	332-6N				0.8				
	160412-6N	333-6N				1.2				
 Standard type	TNGA160404-6N	TNGA331-6N		□□ST30S	6	9.525	3.81	4.76	0.4	3.0
	160408-6N	332-6N							0.8	
	160412-6N	333-6N							1.2	
	TNGA160404-6N	TNGA331-6N		□□CBR430S	6	0.4				
	160408-6N	332-6N				0.8				
	160412-6N	333-6N				1.2				

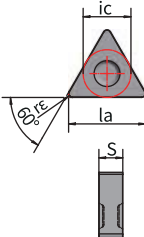
PCBN insert -Hardened Steel

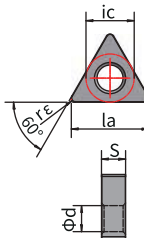
Tipped Inserts

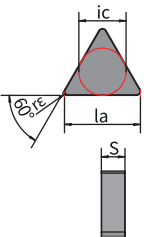
TN	60°Square-Negative-Solid
	PCBN Negative

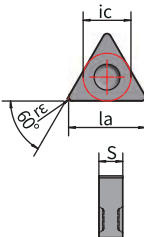
H	
Applications	
Structure	SS
Material code	PNH2026 PNH2028
Cutting edge	S0102010 S0202020
Coating	S/C3/CE

Shape	ISO	ANSI	Tips forming		Cutting edges	ic	φd	S	r	la
	TNGN160408-6N	TNGN332-6N		SSST160S	6	9.525	—	4.76	0.8	16
	160412-6N	333-6N							1.2	
	160416-6N	334-6N							1.6	
	TNGN160408-6N	TNGN332-6N		SSCBR6160S	6				0.8	
	160412-6N	333-6N							1.2	
	160416-6N	334-6N							1.6	
	TNGX160408-6N	TNGX332-6N		SSST160S	6	9.525	—	4.76	0.8	16
	160412-6N	333-6N							1.2	
	160416-6N	334-6N							1.6	
	TNGX160408-6N	TNGX332-6N		SSCBR6160S	6				0.8	
	160412-6N	333-6N							1.2	
	160416-6N	334-6N							1.6	
	TNGA160408-6N	TNGA332-6N		SSST160S	6	9.525	3.81	4.76	0.8	16
	160412-6N	333-6N							1.2	
	160416-6N	334-6N							1.6	
	TNGA160408-6N	TNGA332-6N		SSCBR6160S	6				0.8	
	160412-6N	333-6N							1.2	
	160416-6N	334-6N							1.6	
	TNGN160708-6N	TNGN352-6N		SSST160S	6	9.525	—	7.94	0.8	16
	160712-6N	353-6N							1.2	
	160716-6N	354-6N							1.6	
	TNGN160708-6N	TNGN352-6N		SSCBR6160S	6				0.8	
	160712-6N	353-6N							1.2	
	160716-6N	354-6N							1.6	
	TNGX160708-6N	TNGX352-6N		SSST160S	6	9.525	—	7.94	0.8	16
	160712-6N	353-6N							1.2	
	160716-6N	354-6N							1.6	
	TNGX160708-6N	TNGX352-6N		SSCBR6160S	6				0.8	
	160712-6N	353-6N							1.2	
	160716-6N	354-6N							1.6	

PCBN insert -Hardened Steel

Tipped Inserts

TN	60°Square-Negative-Full length
	PCBN Negative

H		
Applications	○	○ ⊕
Structure	SWU	SWU
Material code	PNH0120 PNH0124	PNH2016 PNH2024
Cutting edge	S0102010 S0202020	
Coating	S/C3/CE	

Shape	ISO	ANSI	Tips forming	Cutting edges	ic	φd	S	r	la
	TNGA160408-6N	TNGA332-6N		SWUST25S	6	9.525	3.81	4.76	0.8
	160412-6N	333-6N							1.2
	160416-6N	334-6N							1.6
	TNGA160408-6N	TNGA332-6N		SWUCBR625S	6	9.525	3.81	4.76	0.8
	160412-6N	333-6N							1.2
	160416-6N	334-6N							1.6

PCBN insert -Hardened Steel

Tipped Inserts

VN	35°rhombic-Negative-With hole
	PCBN Negative

H				
Applications				
Structure	SL	SL	SL	CB
Material code	PNH0120 PNH0122 PNH0124	PNH1020 PNH1022 PNH1024	PNH2016 PNH2018 PNH2024	PNH3019 PNH3023
Cutting edge	S0054505 S0102005 S0152510	S0152510 S0153510	S0152510 S0153510 S0203520	S0102005 S0153510
Coating	S/C3/CE	S/C3/CE	S/C3/CE	S/C3

Shape	ISO	ANSI	Tips forming	Cutting edges	ic	φd	S	r	la
 Conventional mini type	VNGA160404-2N	VNGA331-2N	 □□ST22S	2	9.525	3.81	4.76	0.4	2.2
	160408-2N	332-2N						0.8	
	160412-2N	333-2N						1.2	
	VNGA160404-2N	VNGA331-2N	 □□CBR422S	2				0.4	
	160408-2N	332-2N						0.8	
	160412-2N	333-2N						1.2	
 Standard type	VNGA160404-2N	VNGA331-2N	 □□ST30S	2	9.525	3.81	4.76	0.4	3.0
	160408-2N	332-2N						0.8	
	160412-2N	333-2N						1.2	
	VNGA160404-2N	VNGA331-2N	 □□CBR430S	2				0.4	
	160408-2N	332-2N						0.8	
	160412-2N	333-2N						1.2	
 long cutting edge	VNGA160408-2N	VNGA332-2N	 □□ST40S	2	9.525	3.81	4.76	0.8	4.0
	160412-2N	333-2N						1.2	
	160416-2N	334-2N						1.6	
	VNGA160408-2N	VNGA332-2N	 □□CBR640S	2				0.8	
	160412-2N	333-2N						1.2	
	160416-2N	334-2N						1.6	
 Conventional mini type	VNGA160404-4N	VNGA331-4N	 □□ST22S	4	9.525	3.81	4.76	0.4	2.2
	160408-4N	332-4N						0.8	
	160412-4N	333-4N						1.2	
	VNGA160404-4N	VNGA331-4N	 □□CBR422S	4				0.4	
	160408-4N	332-4N						0.8	
	160412-4N	333-4N						1.2	
 Standard type	VNGA160404-4N	VNGA331-4N	 □□ST30S	4	9.525	3.81	4.76	0.4	3.0
	160408-4N	332-4N						0.8	
	160412-4N	333-4N						1.2	
	VNGA160404-4N	VNGA331-4N	 □□CBR430S	4				0.4	
	160408-4N	332-4N						0.8	
	160412-4N	333-4N						1.2	
 long cutting edge	VNGA160408-4N	VNGA332-4N	 □□ST40S	4	9.525	3.81	4.76	0.8	4.0
	160412-4N	333-4N						1.2	
	160416-4N	334-4N						1.6	
	VNGA160408-4N	VNGA332-4N	 □□CBR640S	4				0.8	
	160412-4N	333-4N						1.2	
	160416-4N	334-4N						1.6	

PCBN insert -Hardened Steel

Tipped Inserts

VN	35°rhombic-Negative-Solid
	PCBN Negative

H	
Applications	
Structure	SS
Material code	PNH2028
Cutting edge	S0102010 S0202020
Coating	S/C3/CE

Shape	ISO	ANSI	Tips forming		Cutting edges	ic	φd	S	r	la
 	VNGN160408-4N	VNGN332-4N	 SSST160S	4	9.525	—	4.76	0.8	16	
	160412-4N	333-4N						1.2		
	160416-4N	334-4N						1.6		
	VNGN160408-4N	VNGN332-4N	 SSCBR6160S	4				0.8		
	160412-4N	333-4N						1.2		
	160416-4N	334-4N						1.6		
 	VNGX160408-4N	VNGX332-4N	 SSST160S	4	9.525	—	4.76	0.8	16	
	160412-4N	333-4N						1.2		
	160416-4N	334-4N						1.6		
	VNGX160408-4N	VNGX332-4N	 SSCBR6160S	4				0.8		
	160412-4N	333-4N						1.2		
	160416-4N	334-4N						1.6		
 	VNGA160408-4N	VNGA332-4N	 SSST160S	4	9.525	3.81	4.76	0.8	16	
	160412-4N	333-4N						1.2		
	160416-4N	334-4N						1.6		
	VNGA160408-4N	VNGA332-4N	 SSCBR6160S	4				0.8		
	160412-4N	333-4N						1.2		
	160416-4N	334-4N						1.6		
 	VNGN160708-4N	VNGN352-4N	 SSST160S	4	9.525	—	7.94	0.8	16	
	160712-4N	353-4N						1.2		
	160716-4N	354-4N						1.6		
	VNGN160708-4N	VNGN352-4N	 SSCBR6160S	4				0.8		
	160712-4N	353-4N						1.2		
	160716-4N	354-4N						1.6		
 	VNGX160708-4N	VNGX352-4N	 SSST160S	4	9.525	—	7.94	0.8	16	
	160712-4N	353-4N						1.2		
	160716-4N	354-4N						1.6		
	VNGX160708-4N	VNGX352-4N	 SSCBR6160S	4				0.8		
	160712-4N	353-4N						1.2		
	160716-4N	354-4N						1.6		

PCBN insert -Hardened Steel

Tipped Inserts

VN	35°rhombic-Negative-Full length
	PCBN Negative

H		
Applications	○	⊕ ⊗
Structure	SWU	SWU
Material code	PNH0120 PNH0124	PNH2016 PNH2024
Cutting edge	S0102010 S0202020	
Coating	S/C3/CE S/C3/CE	

Shape	ISO	ANSI	Tips forming	Cutting edges	ic	φd	S	r	la
	VNGA160408-4N	VNGA332-4N		4	9.525	3.81	4.76	0.8	2.5
	160412-4N	333-4N						1.2	
	160416-4N	334-4N						1.6	
	VNGA160408-4N	VNGA332-4N		4	9.525	3.81	4.76	0.8	
	160412-4N	333-4N						1.2	
	160416-4N	334-4N						1.6	

PCBN insert -Hardened Steel

Tipped Inserts

WN	80°hexagonal-Negative-With hole
	PCBN Negative

H				
Applications				
Structure	SL	SL	SL	CB
Material code	PNH0120 PNH0122 PNH0124	PNH1020 PNH1022 PNH1024	PNH2016 PNH2018 PNH2024	PNH3019 PNH3023
Cutting edge	S0054505 S0102005 S0152510	S0152510 S0153510	S0152510 S0153510 S0203520	S0102005 S0153510
Coating	S/C3/CE	S/C3/CE	S/C3/CE	S/C3

Shape	ISO	ANSI	Tips forming	Cutting edges	ic	φd	S	r	la
 Conventional mini type	WNGA080404-3N	WNGA431-3N		□□ST22S	3	12.7	5.16	4.76	0.4
	080408-3N	432-3N		□□WGR22S	3				0.8
	080412-3N	433-3N		□□CBR422S	3				1.2
	WNGA080404-3N	WNGA431-3N		□□ST22S	3				0.4
	080408-3N	432-3N		□□WGR22S	3				0.8
	080412-3N	433-3N		□□CBR422S	3				1.2
	WNGA080404-3N	WNGA431-3N		□□ST22S	3				0.4
	080408-3N	432-3N		□□WGR22S	3				0.8
	080412-3N	433-3N		□□CBR422S	3				1.2
 Standard type	WNGA080404-3N	WNGA431-3N		□□ST30S	3	12.7	5.16	4.76	0.4
	080408-3N	432-3N		□□WGR30S	3				0.8
	080412-3N	433-3N		□□CBR430S	3				1.2
	WNGA080404-3N	WNGA431-3N		□□ST30S	3				0.4
	080408-3N	432-3N		□□WGR30S	3				0.8
	080412-3N	433-3N		□□CBR430S	3				1.2
	WNGA080404-3N	WNGA431-3N		□□ST30S	3				0.4
	080408-3N	432-3N		□□WGR30S	3				0.8
	080412-3N	433-3N		□□CBR430S	3				1.2
 long cutting edge	WNGA080408-3N	WNGA432-3N		□□ST40S	3	12.7	5.16	4.76	0.8
	080412-3N	433-3N		□□WGR40S	3				1.2
	080416-3N	434-3N		□□CBR640S	3				1.6
	WNGA080408-3N	WNGA432-3N		□□ST40S	3				0.8
	080412-3N	433-3N		□□WGR40S	3				1.2
	080416-3N	434-3N		□□CBR640S	3				1.6
	WNGA080408-3N	WNGA432-3N		□□ST40S	3				0.8
	080412-3N	433-3N		□□WGR40S	3				1.2
	080416-3N	434-3N		□□CBR640S	3				1.6
 Conventional mini type	WNGA080404-6N	WNGA431-6N		□□ST22S	6	12.7	5.16	4.76	0.4
	080408-6N	432-6N		□□WGR22S	6				0.8
	080412-6N	433-6N		□□CBR422S	6				1.2
	WNGA080404-6N	WNGA431-6N		□□ST22S	6				0.4
	080408-6N	432-6N		□□WGR22S	6				0.8
	080412-6N	433-6N		□□CBR422S	6				1.2
	WNGA080404-6N	WNGA431-6N		□□ST22S	6				0.4
	080408-6N	432-6N		□□WGR22S	6				0.8
	080412-6N	433-6N		□□CBR422S	6				1.2
 Standard type	WNGA080404-6N	WNGA431-6N		□□ST30S	6	12.7	5.16	4.76	0.4
	080408-6N	432-6N		□□WGR30S	6				0.8
	080412-6N	433-6N		□□CBR430S	6				1.2
	WNGA080404-6N	WNGA431-6N		□□ST30S	6				0.4
	080408-6N	432-6N		□□WGR30S	6				0.8
	080412-6N	433-6N		□□CBR430S	6				1.2
	WNGA080404-6N	WNGA431-6N		□□ST30S	6				0.4
	080408-6N	432-6N		□□WGR30S	6				0.8
	080412-6N	433-6N		□□CBR430S	6				1.2
 long cutting edge	WNGA080408-6N	WNGA432-6N		□□ST40S	6	12.7	5.16	4.76	0.8
	080412-6N	433-6N		□□WGR40S	6				1.2
	080416-6N	434-6N		□□CBR640S	6				1.6
	WNGA080408-6N	WNGA432-6N		□□ST40S	6				0.8
	080412-6N	433-6N		□□WGR40S	6				1.2
	080416-6N	434-6N		□□CBR640S	6				1.6
	WNGA080408-6N	WNGA432-6N		□□ST40S	6				0.8
	080412-6N	433-6N		□□WGR40S	6				1.2
	080416-6N	434-6N		□□CBR640S	6				1.6

PCBN insert -Hardened Steel

Tipped Inserts

WN	80°hexagonal-Negative-Solid
	PCBN Negative

H	
Applications	
Structure	SS
Material code	PNH2026 PNH2028
Cutting edge	S0102010 S0202020
Coating	S/C3/CE

Shape	ISO	ANSI	Tips forming		Cutting edges	ic	φd	S	r	la
	WNGN080408-6N	WNGN432-6N		SSST80S	6	12.7	—	4.76	0.8	8
	080412-6N	433-6N							1.2	
	080416-6N	434-6N							1.6	
	WNGN080408-6N	WNGN432-6N		SSWGR80S	6				0.8	
	080412-6N	433-6N							1.2	
	080416-6N	434-6N							1.6	
	WNGN080408-6N	WNGN432-6N		SSCBR680S	6				0.8	
	080412-6N	433-6N							1.2	
	080416-6N	434-6N							1.6	
	WNGX080408-6N	WNGX432-6N		SSST80S	6	12.7	—	4.76	0.8	8
	080412-6N	433-6N							1.2	
	080416-6N	434-6N							1.6	
	WNGX080408-6N	WNGX432-6N		SSWGR80S	6				0.8	
	080412-6N	433-6N							1.2	
	080416-6N	434-6N							1.6	
	WNGX080408-6N	WNGX432-6N		SSCBR680S	6				0.8	
	080412-6N	433-6N							1.2	
	080416-6N	434-6N							1.6	
	WNGA080408-6N	WNGA432-6N		SSST80S	6	12.7	5.16	4.76	0.8	8
	080412-6N	433-6N							1.2	
	080416-6N	434-6N							1.6	
	WNGA080408-6N	WNGA432-6N		SSWGR80S	6				0.8	
	080412-6N	433-6N							1.2	
	080416-6N	434-6N							1.6	
	WNGA080408-6N	WNGA432-6N		SSCBR680S	6				0.8	
	080412-6N	433-6N							1.2	
	080416-6N	434-6N							1.6	

WN	80°hexagonal-Negative-Full length
	PCBN Negative



H	
Applications	
Structure	SWU
Material code	PNH0120 PNH0124 PNH2016 PNH2024
Cutting edge	S0102010 S0202020
Coating	S/C3/CE











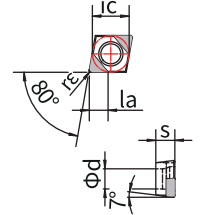

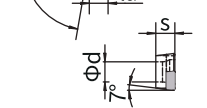

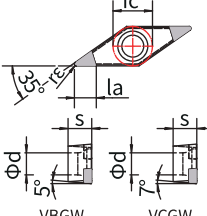
Shape	ISO	ANSI	Tips forming		Cutting edges	ic	φd	S	r	la
	WNGA080408-6N	WNGA432-6N		SWUST25S	6	12.7	5.16	4.76	0.8	2.5
	080412-6N	433-6N							1.2	
	080416-6N	434-6N							1.6	
	WNGA080408-6N	WNGA432-6N		SWUWGR25S	6				0.8	
	080412-6N	433-6N							1.2	
	080416-6N	434-6N							1.6	
	WNGA080408-6N	WNGA432-6N		SWUCBR625S	6				0.8	
	080412-6N	433-6N							1.2	
	080416-6N	434-6N							1.6	

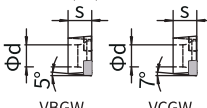
PCBN insert -Hardened Steel

Tipped Inserts

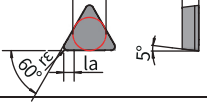
C/V T/W	Microminiature insert
	PCBN Positive

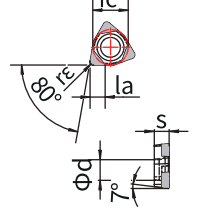

H		
Applications		
Structure	SL	SL
Material code	PNH0120	PNH2018
Cutting edge	S0102010 S0202020	
Coating	S/C3/CE	







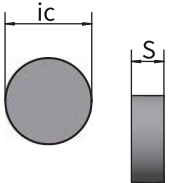

Shape	ISO	ANSI	Tips forming		Cutting edges	ic	φd	S	r	la
	CCGW030102-2N	—		□□ST18S	2	3.5	1.9	1.8	0.2	1.8
	030104-2N	—							0.4	
	CCGW040102-2N	CCGW(1.5)1(0.5)-2N		□□ST18S	2	4.3	2.2	1.8	0.2	1.8
	040104-2N	(1.5)11-2N							0.4	
	VCGW070202-2N	VCGW(1.2)(1.5)(0.5)-2N		□□ST22S	2	3.97	2.2	2.38	0.2	2.2
	070204-2N	(1.2)(1.5)1-2N							0.4	
	VBGW070202-2N	VBGW(1.2)(1.5)(0.5)-2N		□□ST22S	2	3.97	2.2	2.38	0.2	2.2
	070204-2N	(1.2)(1.5)1-2N							0.4	
	TCGW06T102-2N	—		□□ST18S	3	3.97	2.2	1.98	0.2	1.8
06T104-2N	—	0.4								
	TBGN060104-3N	TBGN(1.2)11-3N		SFST40S	3	3.97	—	1.59	0.2	6.0
060104-3N	TBGN(1.2)11-3N	0.4								
	WCGW020102-3N	WCGW(1.2)1(0.5)-3N		□□ST17S	3	3.97	2.2	1.59	0.2	1.7
	020104-3N	(1.2)11-3N							0.4	

PCBN insert -Hardened Steel

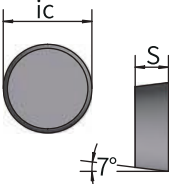
Tipped Inserts

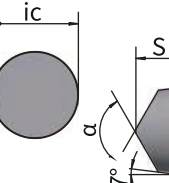
RN/RC	Circular-Solid
	PCBN Circular

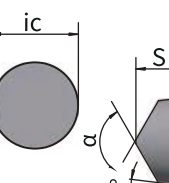
H		
Applications		
Structure	SS	SS
Material code	PNH2026 PNH2028	PNH3020
Cutting edge	S0102010	S0202020
Coating	S/C3/CE	S/C3/CE
Notes: PNH2026/PNH2028 offer a variety of inserts thicker than 4.76cm		

Shape	ISO	ANSI	Tips forming	Cutting edges	ic	φd	S	r	la
	RNGN060300	RNGN22		SSST64S	6.35	—	3.18	—	—
	RNGN090300	RNGN32		SSST95S	9.525		3.18		
	RNGN090400	RNGN33		SSST95S	9.525		4.76		
	RNGN120300	RNGN42		SSST127S	12.7		3.18		
	RNGN120400	RNGN43		SSST127S	12.7		4.76		
	RNGN120700	RNGN45		SSST127S	12.7		7.94		
	RNGN150700	RNGN55		SSST159S	15.875		7.94		
	RNGN190400	RNGN63		SSST190S	19.05		4.76		
	RNGN190700	RNGN65		SSST190S	19.05		7.94		
	RNGN200800	—		SSST200S	20		8		
	RNGN201000	—		SSST200S	20		10		
	RNGN250400	RNGN83		SSST254S	25.4		4.76		
	RNGN250700	RNGN85		SSST254S	25.4		7.94		
		RCGN0603MO		—			SSST60S		
RCGN060300		RCGN22	SSST64S	6.35		3.18			
RCGN090300		RCGN32	SSST95S	9.525		3.18			
RCGN090400		RCGN33	SSST95S	9.525		4.76			
RCGN120300		RCGN42	SSST127S	12.7		3.18			
RCGN120400		RCGN43	SSST127S	12.7		4.76			
RCGN120700		RCGN45	SSST127S	12.7		7.94			
	RCGX060400	RCGX23		SSST64S	6.35	—	4.76	—	—
	RCGX060500	RCGX2(3.5)		SSST64S	6.35		5.56		
	RCGX090400	RCGX33		SSST95S	9.525		4.76		
	RCGX100400	—		SSST100S	10		4.76		
	RCGX120700	RCGX45		SSST127S	12.7		7.94		
	RCGX150700	RCGX55		SSST190S	15.875		7.94		
	RCGX191000	—		SSST190S	19.05		10		
	RCGX201200	—		SSST200S	20		12		
	RCGX060400-V	RCGX23		SSST64S	6.35	—	4.76	—	—
	RCGX080400-V	—		SSST80S	8		4.76		

PCBN insert -Hardened Steel

Tipped Inserts

RN/RC	Circular-Full face
	PCBN Circular

H		
Applications	○	⊕
Structure	SF	SF
Material code	PNH3013	PNH3023
Cutting edge	S0102010 S0202020	
Coating	S/C3/CE	





Shape	ISO	ANSI	Tips forming		Cutting edges	ic	φd	S	r	la
	RNGN060300	RNGN22		SFST64S	—	6.35	—	3.18	—	—
	RNGN090300	RNGN32		SFST95S		9.525		3.18		
	RNGN090400	RNGN33		SFST95S		9.525		4.76		
	RNGN120300	RNGN42		SFST127S		12.7		3.18		
	RNGN120400	RNGN43		SFST127S		12.7		4.76		
	RNGN120700	RNGN45		SFST127S		12.7		7.94		
	RNGN150700	RNGN55		SFST159S		15.875		7.94		
	RCGN0603MO	—		SFST60S	—	6	—	3.18	—	—
	RCGN060300	RCGN22		SFST65S		6.35		3.18		
	RCGN090300	RCGN32		SFST95S		9.525		3.18		
	RCGN090400	RCGN33		SFST95S		9.525		4.76		
	RCGN120300	RCGN42		SFST127S		12.7		3.18		
	RCGN120400	RCGN43		SFST127S		12.7		4.76		
	RCGN120700	RCGN45		SFST127S		12.7		7.94		
	RCGX060400	RCGX23		SFST65S	—	6.35	—	4.76	—	—
	RCGX060500	RCGX2(3.5)		SFST65S		6.35		5.56		
	RCGX090400	RCGX33		SFST95S		9.525		4.76		
	RCGX100400	—		SFST100S		10		4.76		
	RCGX120700	RCGX45		SFST127S		12.7		7.94		
	RCGX060400-V	RCGX23		SFST65S	—	6.35	—	4.76	—	—
	RCGX080400-V	—		SFST80S		8		4.76		
	RCGW050200	RCGW(1.8)(1.5)		SFST56S	—	5.56	—	2.38	—	—
	RCGW060300	RCGW22		SFST64S		6.35		3.18		

PCBN insert-Cast Iron

Tipped insert

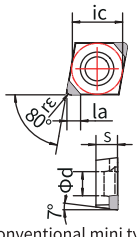

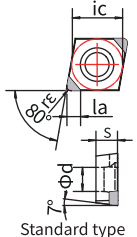

CC	80° rhombic-Positive-With hole
	PCBN Positive

K					
Applications	○ ☺		⚙ ⚙		
Structure	SL	CB	SL	CB	
Material code	PNK0126	PNK0107	PNK0122	PNK3003	PNK3007 PNK3013
Cutting edge	S0102005 S0202010				
Coating	S/C3				

Shape	ISO	ANSI	Tips forming		Cutting edges	ic	φd	S	r	la
 <p>Conventional mini type</p>	CCGW060202-2N	CCGW2(1.5)(0.5)-2N		□□ST22S	2	6.35	2.8	2.38	0.2	2.2
	060204-2N	2(1.5)1-2N								
	060208-2N	2(1.5)2-2N	0.8							
	CCGW060202-2N	CCGW2(1.5)(0.5)-2N	0.2							
	060204-2N	2(1.5)1-2N	0.4							
	060208-2N	2(1.5)2-2N	0.8							
 <p>Standard type</p>	CCGW060202-2N	CCGW2(1.5)(0.5)-2N		□□ST30S	2	6.35	2.8	2.38	0.2	3.0
	060204-2N	2(1.5)1-2N								
	060208-2N	2(1.5)2-2N	0.8							
	CCGW060202-2N	CCGW2(1.5)(0.5)-2N	0.2							
	060204-2N	2(1.5)1-2N	0.4							
	060208-2N	2(1.5)2-2N	0.8							

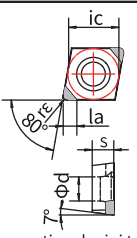
CC	80° rhombic-Positive-With hole
	PCBN Positive

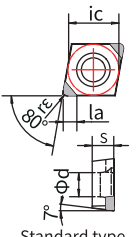
K					
Applications	○ ☺		⚙ ⚙		
Structure	SL	CB	SL	CB	
Material code	PNK0126	PNK0107	PNK0122	PNK3003	PNK3007 PNK3013
Cutting edge	S0102005 S0202010				
Coating	S/C3				





Shape	ISO	ANSI	Tips forming		Cutting edges	ic	φd	S	r	la
 <p>Conventional mini type</p>	CCGW09T304-2N	CCGW3(2.5)1-2N		□□ST22S	2	9.525	4.4	3.97	0.4	2.2
	09T308-2N	3(2.5)2-2N								
	09T312-2N	3(2.5)3-2N	1.2							
	CCGW09T304-2N	CCGW3(2.5)1-2N	0.4							
	09T308-2N	3(2.5)2-2N	0.8							
	09T312-2N	3(2.5)3-2N	1.2							
 <p>Standard type</p>	CCGW09T304-2N	CCGW3(2.5)1-2N		□□ST30S	2	9.525	4.4	3.97	0.4	3.0
	09T308-2N	3(2.5)2-2N								
	09T312-2N	3(2.5)3-2N	1.2							
	CCGW09T304-2N	CCGW3(2.5)1-2N	0.4							
	09T308-2N	3(2.5)2-2N	0.8							
	09T312-2N	3(2.5)3-2N	1.2							

PCBN insert-Cast Iron

Tipped insert

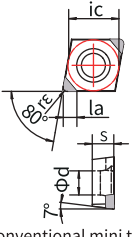

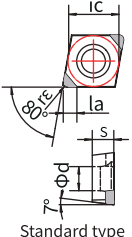



CC	80° rhombic-Positive-With hole
	PCBN Positive

K					
Applications	○ ☺		⚙ ⚙		
Structure	SL	CB	SL	CB	
Material code	PNK0126	PNK0107	PNK0122	PNK3003	PNK3007 PNK3013
Cutting edge	S0102005 S0202010				
Coating	S/C3				

Shape	ISO	ANSI	Tips forming	Cutting edges	ic	φd	S	r	la
 <p>Conventional mini type</p>	CCGW120404-2N	CCGW431-2N	 <p>□□ST22S</p>	2	12.7	5.5	4.76	0.4	2.2
	120408-2N	432-2N						0.8	
	120412-2N	433-2N						1.2	
	CCGW120404-2N	CCGW431-2N	 <p>□□WGR22S</p>	2				0.4	
	120408-2N	432-2N						0.8	
	120412-2N	433-2N						1.2	
 <p>Standard type</p>	CCGW120404-2N	CCGW431-2N	 <p>□□ST30S</p>	2	12.7	5.5	4.76	0.4	3.0
	120408-2N	432-2N						0.8	
	120412-2N	433-2N						1.2	
	CCGW120404-2N	CCGW431-2N	 <p>□□WGR30S</p>	2				0.4	
	120408-2N	432-2N						0.8	
	120412-2N	433-2N						1.2	

DC	55° rhombic-Positive-With hole
	PCBN Positive

K					
Applications	○ ☺		⚙ ⚙		
Structure	SL	CB	SL	CB	
Material code	PNK0126	PNK0107	PNK0122	PNK3003	PNK3007 PNK3013
Cutting edge	S0102005 S0202010				
Coating	S/C3				

Shape	ISO	ANSI	Tips forming	Cutting edges	ic	φd	S	r	la
 <p>Conventional mini type</p>	DCGW070202-2N	DCGW2(1.5)(0.5)-2N	 <p>□□ST22S</p>	2	6.35	2.8	2.38	0.2	2.2
	070204-2N	2(1.5)1-2N						0.4	
	070208-2N	2(1.5)2-2N						0.8	
	DCGW070202-2N	DCGW2(1.5)(0.5)-2N	 <p>□□WGR22S (107.5°)</p>	2				0.2	
	070204-2N	2(1.5)1-2N						0.4	
	070208-2N	2(1.5)2-2N						0.8	
 <p>Standard type</p>	DCGW070202-2N	DCGW2(1.5)(0.5)-2N	 <p>□□ST30S</p>	2	6.35	2.8	2.38	0.2	3.0
	070204-2N	2(1.5)1-2N						0.4	
	070208-2N	2(1.5)2-2N						0.8	
	DCGW070202-2N	DCGW2(1.5)(0.5)-2N	 <p>□□WGR30S (107.5°)</p>	2				0.2	
	070204-2N	2(1.5)1-2N						0.4	
	070208-2N	2(1.5)2-2N						0.8	

PCBN insert-Cast Iron

Tipped insert

DC	55°rhombic-Positive-With hole
	PCBN Positive

K					
Applications	○ ○		⊕ ⊗		
Structure	SL	CB	SL	CB	
Material code	PNK0126	PNK0107	PNK0122	PNK3003	PNK3007 PNK3013
Cutting edge	S0102005 S0202010				
Coating	S/C3				

Shape	ISO	ANSI	Tips forming		Cutting edges	ic	φd	S	r	la
<p>Conventional mini type</p>	DCGW11T304-2N	DCGW3(2.5)1-2N		□□ST22S	2	9.525	4.4	3.97	0.4	2.2
	11T308-2N	3(2.5)2-2N							0.8	
	11T312-2N	3(2.5)3-2N							1.2	
	DCGW11T304-2N	DCGW3(2.5)1-2N		□□WGR22S (107.5°)	2	9.525	4.4	3.97	0.4	
	11T308-2N	3(2.5)2-2N							0.8	
	11T312-2N	3(2.5)3-2N							1.2	
<p>Standard type</p>	DCGW11T304-2N	DCGW3(2.5)1-2N		□□ST30S	2	9.525	4.4	3.97	0.4	3.0
	11T308-2N	3(2.5)2-2N							0.8	
	11T312-2N	3(2.5)3-2N							1.2	
	DCGW11T304-2N	DCGW3(2.5)1-2N		□□WGR30S (107.5°)	2	9.525	4.4	3.97	0.4	
	11T308-2N	3(2.5)2-2N							0.8	
	11T312-2N	3(2.5)3-2N							1.2	

DC	55°rhombic-Positive-With hole
	PCBN Positive

K					
Applications	○ ○		⊕ ⊗		
Structure	SL	CB	SL	CB	
Material code	PNK0126	PNK0107	PNK0122	PNK3003	PNK3007 PNK3013
Cutting edge	S0102005 S0202010				
Coating	S/C3				





Shape	ISO	ANSI	Tips forming		Cutting edges	ic	φd	S	r	la
<p>Conventional mini type</p>	DCGW150404-2N	DCGW431-2N		□□ST22S	2	12.7	5.5	4.76	0.4	2.2
	150408-2N	432-2N							0.8	
	150412-2N	433-2N							1.2	
	DCGW150404-2N	DCGW431-2N		□□WGR22S (107.5°)	2	12.7	5.5	4.76	0.4	
	150408-2N	432-2N							0.8	
	150412-2N	433-2N							1.2	
<p>Standard type</p>	DCGW150404-2N	DCGW431-2N		□□ST30S	2	12.7	5.5	4.76	0.4	3.0
	150408-2N	432-2N							0.8	
	150412-2N	433-2N							1.2	
	DCGW150404-2N	DCGW431-2N		□□WGR30S (107.5°)	2	12.7	5.5	4.76	0.4	
	150408-2N	432-2N							0.8	
	150412-2N	433-2N							1.2	

PCBN insert-Cast Iron

Tipped insert

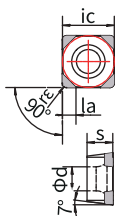
SC	90°Square-Positive-With hole
	PCBN Positive

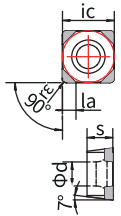
K					
Applications	○ ○		⊕ ⊗		
Structure	SL	CB	SL	CB	
Material code	PNK0126	PNK0107	PNK0122	PNK3003	PNK3007 PNK3013
Cutting edge	S0102005 S0202010				
Coating	S/C3				





Shape	ISO	ANSI	Tips forming		Cutting edges	ic	φd	S	r	la
 <p>Conventional mini type</p>	SCGW09T304-4N	SCGW3(2.5)1-4N		□□ST22S	4	9.525	4.4	3.97	0.4	2.2
	09T308-4N	3(2.5)2-4N							0.8	
	09T312-4N	3(2.5)3-4N							1.2	
 <p>Standard type</p>	SCGW09T304-4N	SCGW3(2.5)1-4N		□□ST30S	4	9.525	4.4	3.97	0.4	3.0
	09T308-4N	3(2.5)2-4N							0.8	
	09T312-4N	3(2.5)3-4N							1.2	

PCBN insert-Cast Iron

Tipped insert

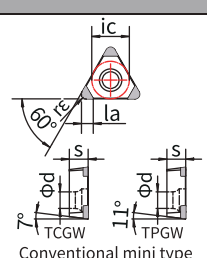

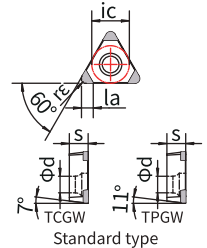

TC/TP	60°Square-Positive-With hole
	PCBN Positive

K					
Applications	○ ☺		⚙ ⚙		
Structure	SL	CB	SL	CB	
Material code	PNK0126	PNK0107	PNK0122	PNK3003	PNK3007 PNK3013
Cutting edge	S0102005 S0202010				
Coating	S/C3				

Shape	ISO	ANSI	Tips forming	Cutting edges	ic	φd	S	r	la
 <p>Conventional mini type</p>	TCGW080202-3N	TCGW(1.5)(1.5)(0.5)-3N		□□ST22S	3	4.76	2.4	2.38	0.2
	080204-3N	(1.5)(1.5)1-3N							0.4
	TPGW080202-3N	TPGW(1.5)(1.5)(0.5)-3N		□□ST22S	3	4.76	2.4	2.38	0.2
	080204-3N	(1.5)(1.5)1-3N							0.4
 <p>Standard type</p>	TCGW080202-3N	TCGW(1.5)(1.5)(0.5)-3N		□□ST30S	3	4.76	2.4	2.38	0.2
	080204-3N	(1.5)(1.5)1-3N							0.4
	TPGW080202-3N	TPGW(1.5)(1.5)(0.5)-3N		□□ST30S	3	4.76	2.4	2.38	0.2
	080204-3N	(1.5)(1.5)1-3N							0.4

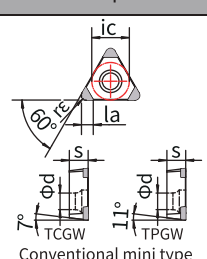
TC/TP	60°Square-Positive-With hole
	PCBN Positive

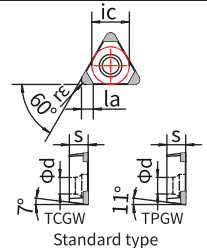
K					
Applications	○ ☺		⚙ ⚙		
Structure	SL	CB	SL	CB	
Material code	PNK0126	PNK0107	PNK0122	PNK3003	PNK3007 PNK3013
Cutting edge	S0102005 S0202010				
Coating	S/C3				

Shape	ISO	ANSI	Tips forming	Cutting edges	ic	φd	S	r	la
 <p>Conventional mini type</p>	TCGW090202-3N	TCGW(1.8)(1.5)(0.5)-3N		□□ST22S	3	5.56	2.4	2.38	0.2
	090204-3N	(1.8)(1.5)1-3N							0.4
	090208-3N	(1.8)(1.5)2-3N							0.8
	TPGW090202-3N	TPGW(1.8)(1.5)(0.5)-3N		□□ST22S	3	5.56	2.8	2.38	0.2
	090204-3N	(1.8)(1.5)1-3N							0.4
	090208-3N	(1.8)(1.5)2-3N							0.8
 <p>Standard type</p>	TCGW090202-3N	TCGW(1.8)(1.5)(0.5)-3N		□□ST30S	3	5.56	2.4	2.38	0.2
	090204-3N	(1.8)(1.5)1-3N							0.4
	090208-3N	(1.8)(1.5)2-3N							0.8
	TPGW090202-3N	TPGW(1.8)(1.5)(0.5)-3N		□□ST30S	3	5.56	2.8	2.38	0.2
	090204-3N	(1.8)(1.5)1-3N							0.4
	090208-3N	(1.8)(1.5)2-3N							0.8

PCBN insert-Cast Iron

Tipped insert

TC/TP	60°Square-Positive-With hole
	PCBN Positive

K					
Applications	○ ○		⚙ ⚙		
Structure	SL	CB	SL	CB	
Material code	PNK0126	PNK0107	PNK0122	PNK3003	PNK3007 PNK3013
Cutting edge	S0102005 S0202010				
Coating	S/C3				

Shape	ISO	ANSI	Tips forming	Cutting edges	ic	φd	S	r	la		
<p>Conventional mini type</p>	TCGW110302-3N	TCGW22(0.5)-3N		□□ST22S	3	6.35	2.8	3.18	0.2	2.2	
	110304-3N	221-3N							0.4		
	110308-3N	222-3N							0.8		
	TPGW110302-3N	TPGW22(0.5)-3N		□□ST22S	3	6.35	3.3	3.18	0.2		
		110304-3N							221-3N		0.4
		110308-3N							222-3N		0.8
<p>Standard type</p>	TCGW110302-3N	TCGW22(0.5)-3N		3	6.35	2.8	3.18	0.2	3.0		
	110304-3N	221-3N						0.4			
	110308-3N	222-3N						0.8			
	TPGW110302-3N	TPGW22(0.5)-3N		□□ST30S	3	6.35	3.3	3.18		0.2	
		110304-3N								221-3N	0.4
		110308-3N								222-3N	0.8

TC/TP	60°Square-Positive-With hole
	PCBN Positive

K					
Applications	○ ○		⚙ ⚙		
Structure	SL	CB	SL	CB	
Material code	PNK0126	PNK0107	PNK0122	PNK3003	PNK3007 PNK3013
Cutting edge	S0102005 S0202010				
Coating	S/C3				





Shape	ISO	ANSI	Tips forming	Cutting edges	ic	φd	S	r	la	
<p>Conventional mini type</p>	TPGW160304-3N	TPGW321-3N		□□ST22S	3	9.525	4.4	3.18	0.4	2.2
	160308-3N	322-3N							0.8	
	160312-3N	323-3N							1.2	
<p>Standard type</p>	TPGW160304-3N	TPGW321-3N		3	9.525	4.4	3.18	0.4	3.0	
	160308-3N	322-3N						0.8		
	160312-3N	323-3N						1.2		

PCBN insert-Cast Iron

Tipped insert

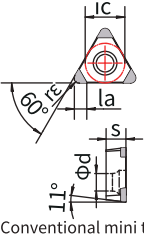

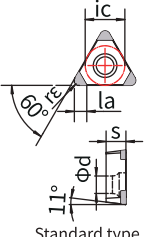



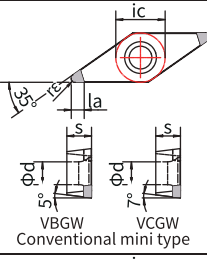

TP	60°Square-Positive-With hole
	PCBN Positive

K					
Applications	○ ☺		⚙ ⚙		
Structure	SL	CB	SL	CB	
Material code	PNK0126	PNK0107	PNK0122	PNK3003	PNK3007 PNK3013
Cutting edge	S0102005 S0202010				
Coating	S/C3				

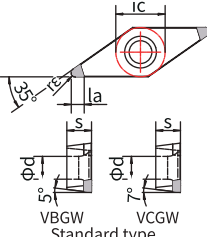
Shape	ISO	ANSI	Tips forming	Cutting edges	ic	φd	S	r	la
 <p>Conventional mini type</p>	TPGW160404-3N	TPGW331-3N		□□ST22S	2	9.525	4.4	4.76	0.4
	160408-3N	332-3N							0.8
	160412-3N	333-3N							1.2
 <p>Standard type</p>	TPGW160404-3N	TPGW331-3N		□□ST30S	2	9.525	4.4	4.76	0.4
	160408-3N	332-3N							0.8
	160412-3N	333-3N							1.2

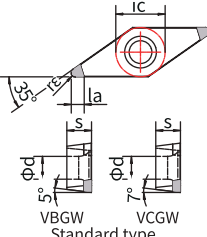
VB/VC	35°rhombic-Positive-With hole
	PCBN Positive

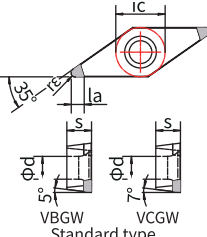
K					
Applications	○ ☺		⚙ ⚙		
Structure	SL	CB	SL	CB	
Material code	PNK0126	PNK0107	PNK0122	PNK3003	PNK3007 PNK3013
Cutting edge	S0102005 S0202010				
Coating	S/C3				

Shape	ISO	ANSI	Tips forming	Cutting edges	ic	φd	S	r	la	
 <p>Conventional mini type</p>	VBGW110302-2N	VBGW22(0.5)-2N		□□ST22S	2	6.35	2.8	3.18	0.2	
	110304-2N	221-2N							0.4	
	110308-2N	222-2N							0.8	
	 <p>Standard type</p>	VCGW110302-2N	VCGW22(0.5)-2N		□□ST22S	2	6.35	2.8	3.18	0.2
		110304-2N	221-2N							0.4
		110308-2N	222-2N							0.8
 <p>Standard type</p>	VBGW110302-2N	VBGW22(0.5)-2N		□□ST30S	2	6.35	2.8	3.18	0.2	
	110304-2N	221-2N							0.4	
	110308-2N	222-2N							0.8	
 <p>Standard type</p>	VCGW110302-2N	VCGW22(0.5)-2N		□□ST30S	2	6.35	2.8	3.18	0.2	
	110304-2N	221-2N							0.4	
	110308-2N	222-2N							0.8	

PCBN insert-Cast Iron

Tipped insert

VB/VC	35°rhombic-Positive-With hole
	PCBN Positive

K					
Applications	○ ○		⚙ ⚙		
Structure	SL	CB	SL	CB	
Material code	PNK0126	PNK0107	PNK0122	PNK3003	PNK3007 PNK3013
Cutting edge	S0102005 S0202010				
Coating	S/C3				











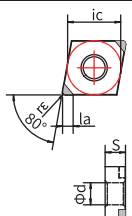

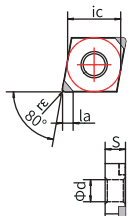
Shape	ISO	ANSI	Tips forming		Cutting edges	ic	φd	S	r	la
<p>VBGW Conventional mini type</p>	VBGW160404-2N	VBGW331-2N		□□ST22S	2	9.525	4.4	4.76	0.4	2.2
	160408-2N	332-2N							0.8	
	160412-2N	333-2N							1.2	
	VCGW160404-2N	VCGW331-2N		□□ST22S	2	9.525	4.4	4.76	0.4	
	160408-2N	332-2N							0.8	
	160412-2N	333-2N							1.2	
<p>VBGW Standard type</p>	VBGW160404-2N	VBGW331-2N		□□ST30S	2	9.525	4.4	4.76	0.4	3.0
	160408-2N	332-2N							0.8	
	160412-2N	333-2N							1.2	
	VCGW160404-2N	VCGW331-2N		□□ST30S	2	9.525	4.4	4.76	0.4	
	160408-2N	332-2N							0.8	
	160412-2N	333-2N							1.2	
<p>VBGW long cutting edge</p>	VBGW160404-2N	VBGW331-2N		□□ST40S	2	9.525	4.4	4.76	0.4	4.0
	160408-2N	332-2N							0.8	
	160412-2N	333-2N							1.2	
	VCGW160404-2N	VCGW331-2N		□□ST40S	2	9.525	4.4	4.76	0.4	
	160408-2N	332-2N							0.8	
	160412-2N	333-2N							1.2	
160416-2N	334-2N	1.6								

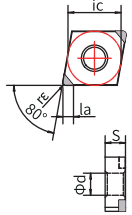
PCBN insert-Cast Iron

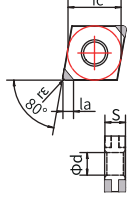
Tipped insert

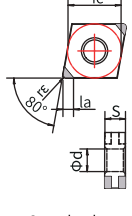
CN	80° rhombic-Negative-With hole
	PCBN Negative

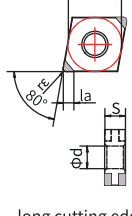

K					
Applications	○ ○		⚙ ⚙		
Structure	SL	CB	SL	CB	
Material code	PNK0126	PNK0107	PNK0122	PNK3003	PNK3007 PNK3013
Cutting edge	S0102005 S0202010				
Coating	S/C3				





Shape	ISO	ANSI	Tips forming		Cutting edges	ic	φd	S	r	la
 Conventional mini type	CNGA120404-2N	CNGA431-2N		□□ST22S	2	12.7	5.16	4.76	0.4	2.2
	120408-2N	432-2N							0.8	
	120412-2N	433-2N							1.2	
	CNGA120404-2N	CNGA431-2N		□□WGR22S	2				0.4	
	120408-2N	432-2N							0.8	
	120412-2N	433-2N							1.2	
 Standard type	CNGA120404-2N	CNGA431-2N		□□ST30S	2	12.7	5.16	4.76	0.4	3.0
	120408-2N	432-2N							0.8	
	120412-2N	433-2N							1.2	
	CNGA120404-2N	CNGA431-2N		□□WGR30S	2				0.4	
	120408-2N	432-2N							0.8	
	120412-2N	433-2N							1.2	
 long cutting edge	CNGA120408-2N	CNGA432-2N		□□ST40S	2	12.7	5.16	4.76	0.8	4.0
	120412-2N	433-2N							1.2	
	120416-2N	434-2N							1.6	
	CNGA120408-2N	CNGA432-2N		□□WGR40S	2				0.8	
	120412-2N	433-2N							1.2	
	120416-2N	434-2N							1.6	
 Conventional mini type	CNGA120404-4N	CNGA431-4N		□□ST22S	4	12.7	5.16	4.76	0.4	2.2
	120408-4N	432-4N							0.8	
	120412-4N	433-4N							1.2	
	CNGA120404-4N	CNGA431-4N		□□WGR22S	4				0.4	
	120408-4N	432-4N							0.8	
	120412-4N	433-4N							1.2	
 Standard type	CNGA120404-4N	CNGA431-4N		□□ST30S	4	12.7	5.16	4.76	0.4	3.0
	120408-4N	432-4N							0.8	
	120412-4N	433-4N							1.2	
	CNGA120404-4N	CNGA431-4N		□□WGR30S	4				0.4	
	120408-4N	432-4N							0.8	
	120412-4N	433-4N							1.2	
 long cutting edge	CNGA120408-4N	CNGA432-4N		□□ST40S	4	12.7	5.16	4.76	0.8	4.0
	120412-4N	433-4N							1.2	
	120416-4N	434-4N							1.6	
	CNGA120408-4N	CNGA432-4N		□□WGR40S	4				0.8	
	120412-4N	433-4N							1.2	
	120416-4N	434-4N							1.6	

PCBN insert-Cast Iron

Tipped insert

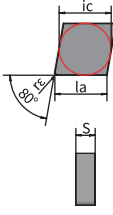
CN	80° rhombic-Negative-Solid
	PCBN Negative

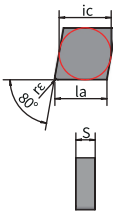
K		
Applications		
Structure	SS	SS
Material code	PNK0110 PNK0118	PNK3020
Cutting edge	E0000005 S0102005 S0202020	
Coating	S/C3	
Notes:PNK0118 offer a variety of inserts thinner than 4.76cm		









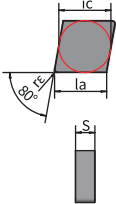

Shape	ISO	ANSI	Tips forming	Cutting edges	ic	φd	S	r	la
	CNGN090304-4N	CNGN321-4N		SSST90S	4	9.525	3.18	0.4	9
	090308-4N	322-4N						0.8	
	090312-4N	323-4N						1.2	
	CNGN090304-4N	CNGN321-4N		SSWGR90S	4	9.525	3.18	0.4	
	090308-4N	322-4N						0.8	
	090312-4N	323-4N						1.2	
	CNGN090404-4N	CNGN331-4N		SSST90S	4	9.525	4.76	0.4	9
	090408-4N	332-4N						0.8	
	090412-4N	333-4N						1.2	
	CNGN090404-4N	CNGN331-4N		SSWGR90S	4	9.525	4.76	0.4	
	090408-4N	332-4N						0.8	
	090412-4N	333-4N						1.2	

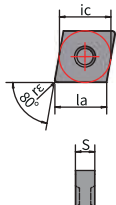
PCBN insert-Cast Iron

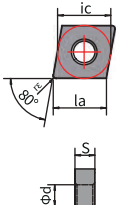
Tipped insert

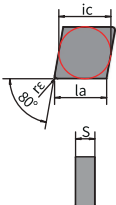
CN	80° rhombic-Negative-Solid
	PCBN Negative

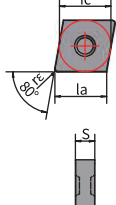
K		
Applications		
Structure	SS	SS
Material code	PNK0110 PNK0118	PNK3020
Cutting edge	E0000005 S0102005 S0202020	
Coating	S/C3	
Notes:PNK0118 offer a variety of inserts thinner than 4.76cm		











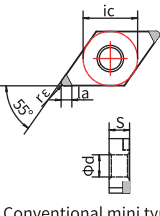

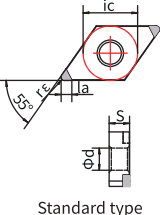
Shape	ISO	ANSI	Tips forming		Cutting edges	ic	φd	S	r	la
	CNGN120408-4N	CNGN432-4N		SSST120S	4	12.7	—	4.76	0.8	12
	120412-4N	433-4N							1.2	
	120416-4N	434-4N							1.6	
	CNGN120408-4N	CNGN432-4N		SSWGR120S	4				0.8	
	120412-4N	433-4N							1.2	
	120416-4N	434-4N							1.6	
	CNGX120408-4N	CNGX432-4N		SSST120S	4	12.7	—	4.76	0.8	12
	120412-4N	433-4N							1.2	
	120416-4N	434-4N							1.6	
	CNGX120408-4N	CNGX432-4N		SSWGR120S	4				0.8	
	120412-4N	433-4N							1.2	
	120416-4N	434-4N							1.6	
	CNGA120408-4N	CNGA432-4N		SSST120S	4	12.7	5.16	4.76	0.8	12
	120412-4N	433-4N							1.2	
	120416-4N	434-4N							1.6	
	CNGA120408-4N	CNGA432-4N		SSWGR120S	4				0.8	
	120412-4N	433-4N							1.2	
	120416-4N	434-4N							1.6	
	CNGN120708-4N	CNGN452-4N		SSST120S	4	12.7	—	7.94	0.8	12
	120712-4N	453-4N							1.2	
	120716-4N	454-4N							1.6	
	CNGN120708-4N	CNGN452-4N		SSWGR120S	4				0.8	
	120712-4N	453-4N							1.2	
	120716-4N	454-4N							1.6	
	CNGX120708-4N	CNGX452-4N		SSST120S	4	12.7	—	7.94	0.8	12
	120712-4N	453-4N							1.2	
	120716-4N	454-4N							1.6	
	CNGX120708-4N	CNGX452-4N		SSWGR120S	4				0.8	
	120712-4N	453-4N							1.2	
	120716-4N	454-4N							1.6	

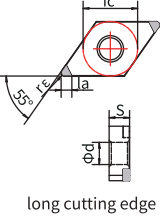
PCBN insert-Cast Iron

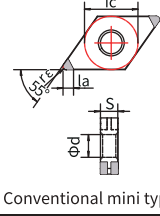
Tipped insert

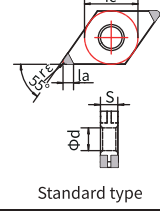
DN	55° rhombic-Negative-With hole
	PCBN Negative

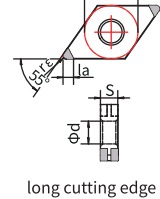
K					
Applications	○ ○		⊕ ⊗		
Structure	SL	CB	SL	CB	
Material code	PNK0126	PNK0107	PNK0122	PNK3003	PNK3007 PNK3013
Cutting edge	S0102005 S0202010				
Coating	S/C3				











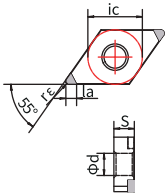

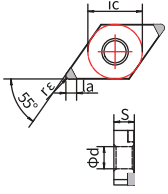
Shape	ISO	ANSI	Tips forming		Cutting edges	ic	φd	S	r	la
 Conventional mini type	DNGA150404-2N	DNGA431-2N		□□ST22S	2	12.7	5.16	4.76	0.4	2.2
	150408-2N	432-2N							0.8	
	150412-2N	433-2N	1.2							
	DNGA150404-2N	DNGA431-2N		□□WGR22S (107.5°)					0.4	
	150408-2N	432-2N							0.8	
	150412-2N	433-2N	1.2							
 Standard type	DNGA150404-2N	DNGA431-2N		□□ST30S	2	12.7	5.16	4.76	0.4	3.0
	150408-2N	432-2N							0.8	
	150412-2N	433-2N	1.2							
	DNGA150404-2N	DNGA431-2N		□□WGR30S (107.5°)					0.4	
	150408-2N	432-2N							0.8	
	150412-2N	433-2N	1.2							
 long cutting edge	DNGA150408-2N	DNGA432-2N		□□ST40S	2	12.7	5.16	4.76	0.8	4.0
	150412-2N	433-2N							1.2	
	150416-2N	434-2N	1.6							
	DNGA150408-2N	DNGA432-2N		□□WGR40S (107.5°)					0.8	
	150412-2N	433-2N							1.2	
	150416-2N	434-2N	1.6							
 Conventional mini type	DNGA150404-4N	DNGA431-4N		□□ST22S	4	12.7	5.16	4.76	0.4	2.2
	150408-4N	432-4N							0.8	
	150412-4N	433-4N	1.2							
	DNGA150404-4N	DNGA431-4N		□□WGR22S (107.5°)					0.4	
	150408-4N	432-4N							0.8	
	150412-4N	433-4N	1.2							
 Standard type	DNGA150404-4N	DNGA431-4N		□□ST30S	4	12.7	5.16	4.76	0.4	3.0
	150408-4N	432-4N							0.8	
	150412-4N	433-4N	1.2							
	DNGA150404-4N	DNGA431-4N		□□WGR30S (107.5°)					0.4	
	150408-4N	432-4N							0.8	
	150412-4N	433-4N	1.2							
 long cutting edge	DNGA150408-4N	DNGA432-4N		□□ST40S	4	12.7	5.16	4.76	0.8	4.0
	150412-4N	433-4N							1.2	
	150416-4N	434-4N	1.6							
	DNGA150408-4N	DNGA432-4N		□□WGR40S (107.5°)					0.8	
	150412-4N	433-4N							1.2	
	150416-4N	434-4N	1.6							

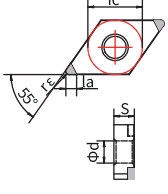
PCBN insert-Cast Iron

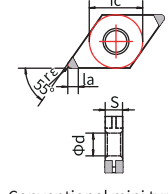
Tipped insert

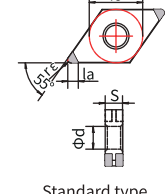
DN	55° rhombic-Negative-With hole
	PCBN Negative

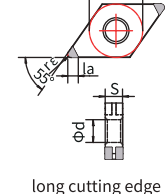

K					
Applications	○ ○		⚙ ⚙		
Structure	SL	CB	SL	CB	
Material code	PNK0126	PNK0107	PNK0122	PNK3003	PNK3007 PNK3013
Cutting edge	S0102005 S0202010				
Coating	S/C3				



Shape	ISO	ANSI	Tips forming		Cutting edges	ic	φd	S	r	la
 Conventional mini type	DNGA150604-2N	DNGA441-2N		□□ST22S	2	12.7	5.16	6.35	0.4	2.2
	150608-2N	442-2N								
	150612-2N	443-2N	1.2							
	DNGA150604-2N	DNGA441-2N	0.4							
	150608-2N	442-2N	0.8							
	150612-2N	443-2N	1.2							
 Standard type	DNGA150604-2N	DNGA441-2N		□□ST30S	2	12.7	5.16	6.35	0.4	3.0
	150608-2N	442-2N								
	150612-2N	443-2N	1.2							
	DNGA150604-2N	DNGA441-2N	0.4							
	150608-2N	442-2N	0.8							
	150612-2N	443-2N	1.2							
 long cutting edge	DNGA150608-2N	DNGA442-2N		□□ST40S	2	12.7	5.16	6.35	0.8	4.0
	150612-2N	443-2N								
	150616-2N	444-2N	1.6							
	DNGA150608-2N	DNGA442-2N	0.8							
	150612-2N	443-2N	1.2							
	150616-2N	444-2N	1.6							
 Conventional mini type	DNGA150604-4N	DNGA441-4N		□□ST22S	4	12.7	5.16	6.35	0.4	2.2
	150608-4N	442-4N								
	150612-4N	443-4N	1.2							
	DNGA150604-4N	DNGA441-4N	0.4							
	150608-4N	442-4N	0.8							
	150612-4N	443-4N	1.2							
 Standard type	DNGA150604-4N	DNGA441-4N		□□ST30S	4	12.7	5.16	6.35	0.4	3.0
	150608-4N	442-4N								
	150612-4N	443-4N	1.2							
	DNGA150604-4N	DNGA441-4N	0.4							
	150608-4N	442-4N	0.8							
	150612-4N	443-4N	1.2							
 long cutting edge	DNGA150608-4N	DNGA442-4N		□□ST40S	4	12.7	5.16	6.35	0.8	4.0
	150612-4N	443-4N								
	150616-4N	444-4N	1.6							
	DNGA150608-4N	DNGA442-4N	0.8							
	150612-4N	443-4N	1.2							
	150616-4N	444-4N	1.6							

PCBN insert-Cast Iron



Tipped insert

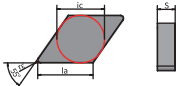





DN	55°rhombic-Negative-Solid
	PCBN Negative

K		
Applications		
Structure	SS	SS
Material code	PNK0110 PNK0118	PNK3020
Cutting edge	E0000005 S0102005 S0202020	
Coating	S/C3	
Notes:PNK0118 offer a variety of inserts thinner than 4.76cm		

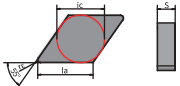

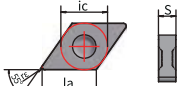
Shape	ISO	ANSI	Tips forming	Cutting edges	ic	φd	S	r	la	
	DNGN110404-4N	DNGN331-4N		SSST110S	4	9.525	—	4.76	0.4	11
	110408-4N	332-4N							0.8	
	110412-4N	333-4N							1.2	

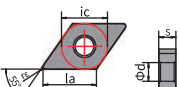



DN	55°rhombic-Negative-Solid
	PCBN Negative

K		
Applications		
Structure	SS	SS
Material code	PNK0110 PNK0118	PNK3020
Cutting edge	E0000005 S0102005 S0202020	
Coating	S/C3	

Shape	ISO	ANSI	Tips forming	Cutting edges	ic	φd	S	r	la	
	DNGN150408-4N	DNGN432-4N		SSST150S	4	12.7	—	4.76	0.8	15
	150412-4N	433-4N							1.2	
	150416-4N	434-4N							1.6	
	DNGX150408-4N	DNGX432-4N		SSST150S	4	12.7	—	4.76	0.8	15
	150412-4N	433-4N							1.2	
	150416-4N	434-4N							1.6	
	DNGA150408-4N	DNGA432-4N		SSST150S	4	12.7	5.16	4.76	0.8	15
	150412-4N	433-4N							1.2	
	150416-4N	434-4N							1.6	

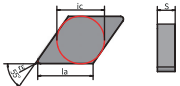
DN	55°rhombic-Negative-Solid
	PCBN Negative

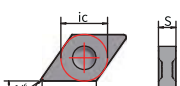
K		
Applications		
Structure	SS	SS
Material code	PNK0110 PNK0118	PNK3020
Cutting edge	E0000005 S0102005 S0202020	
Coating	S/C3	











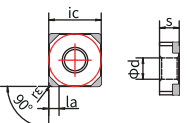

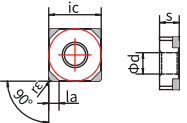
Shape	ISO	ANSI	Tips forming	Cutting edges	ic	φd	S	r	la	
	DNGN150608-4N	DNGN442-4N		SSST150S	4	12.7	—	6.35	0.8	15
	150612-4N	443-4N							1.2	
	150616-4N	444-4N							1.6	
	DNGX150608-4N	DNGX442-4N		SSST150S	4	12.7	—	6.35	0.8	15
	150612-4N	443-4N							1.2	
	150616-4N	444-4N							1.6	

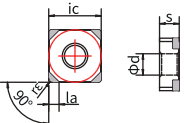
PCBN insert-Cast Iron

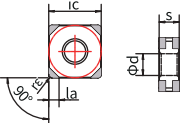
Tipped insert

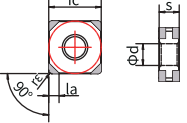
SN	90° square-Negative-With hole
	PCBN Negative

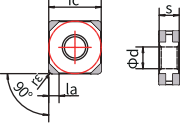
K					
Applications	○ ☺		⚙ ⚙		
Structure	SL	CB	SL	CB	
Material code	PNK0126	PNK0107	PNK0122	PNK3003	PNK3007 PNK3013
Cutting edge	S0102005 S0202010				
Coating	S/C3				

Shape	ISO	ANSI	Tips forming	Cutting edges	ic	φd	S	r	la
 <p>Conventional mini type</p>	SNGA120404-4N	SNGA431-4N		□□ST22S	4	12.7	5.16	4.76	0.4
	120408-4N	432-4N							0.8
	120412-4N	433-4N							1.2
 <p>Standard type</p>	SNGA120404-4N	SNGA431-4N		□□ST30S	4	12.7	5.16	4.76	0.4
	120408-4N	432-4N							0.8
	120412-4N	433-4N							1.2
 <p>long cutting edge</p>	SNGA120408-4N	SNGA432-4N		□□ST40S	4	12.7	5.16	4.76	0.8
	120412-4N	433-4N							1.2
	120416-4N	434-4N							1.8
 <p>Conventional mini type</p>	SNGA120404-8N	SNGA431-8N		□□ST22S	8	12.7	5.16	4.76	0.4
	120408-8N	432-8N							0.8
	120412-8N	433-8N							1.2
 <p>Standard type</p>	SNGA120404-8N	SNGA431-8N		□□ST30S	8	12.7	5.16	4.76	0.4
	120408-8N	432-8N							0.8
	120412-8N	433-8N							1.2
 <p>long cutting edge</p>	SNGA120408-8N	SNGA432-8N		□□ST40S	8	12.7	5.16	4.76	0.8
	120412-8N	433-8N							1.2
	120416-8N	434-8N							1.6

PCBN insert-Cast Iron

Tipped insert

SN	90° square-Negative-Solid
	PCBN Negative

K		
Applications		
Structure	SS	SS
Material code	PNK0110 PNK0118	PNK3020
Cutting edge	E0000005 S0102005 S0202020	
Coating	S/C3	
Notes:PNK0118 offer a variety of inserts thinner than 4.76cm		

Shape	ISO	ANSI	Tips forming	Cutting edges	ic	φd	S	r	la
	SNGN090304-8N	SNGN321-8N		SSST95S	8	9.525	—	3.18	0.4
	90308-8N	322-8N							0.8
	90312-8N	323-8N							1.2
	SNGN090404-8N	SNGN331-8N		SSST95S	8	9.525	—	4.76	0.4
	90408-8N	332-8N							0.8
	90412-8N	333-8N							1.2
	SNGN120408-8N	SNGN432-8N		SSST127S	8	—	4.76	0.8	
	120412-8N	433-8N						1.2	
	120416-8N	434-8N						1.6	
	SNGX120408-8N	SNGX432-8N		SSST127S	8	12.7	—	4.76	0.8
	120412-8N	433-8N							1.2
	120416-8N	434-8N							1.6
	SNGA120408-8N	SNGA432-8N		SSST127S	8	12.7	5.16	4.76	0.8
	120412-8N	433-8N							1.2
	120416-8N	434-8N							1.6
	SNGN120708-8N	SNGN452-8N		SSST127S	8	—	7.94	0.8	
	120712-8N	453-8N						1.2	
	120716-8N	454-8N						1.6	
	SNGX120708-8N	SNGX452-8N		SSST127S	8	12.7	—	7.94	0.8
	120712-8N	453-8N							1.2
	120716-8N	454-8N							1.6
	SNGN150708-8N	SNGN552-8N		SSST127S	8	15.875	—	7.94	0.8
	150712-8N	553-8N							1.2
	150716-8N	554-8N							1.6
	SNGX150708-8N	SNXN552-8N		SSST127S	8	15.875	—	7.94	0.8
	150712-8N	553-8N							1.2
	150716-8N	554-8N							1.6

PCBN insert-Cast Iron

Tipped insert

TN	60°Square-Negative-With hole
	PCBN Negative

K						
Applications						
Structure	SL	CB	SL	CB		
Material code	PNK0126	PNK0107	PNK0122	PNK3003	PNK3007	PNK3013
Cutting edge	S0102005 S0202010					
Coating	S/C3					











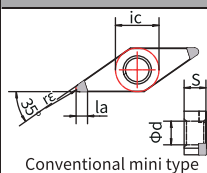

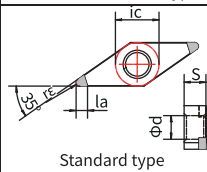
Shape	ISO	ANSI	Tips forming		Cutting edges	ic	φd	S	r	la
<p>Conventional mini type</p>	TNGA160404-3N	TNGA331-3N		□□ST22S	3	9.525	3.81	4.76	0.4	2.2
	160408-3N	332-3N							0.8	
	160412-3N	333-3N							1.2	
	TNGA160404-6N	TNGA331-6N		□□ST22S	6	9.525	3.81	4.76	0.4	
	160408-6N	332-6N							0.8	
	160412-6N	333-6N							1.2	
<p>Standard type</p>	TNGA160404-3N	TNGA331-3N		□□ST30S	3	9.525	3.81	4.76	0.4	3.0
	160408-3N	332-3N							0.8	
	160412-3N	333-3N							1.2	
	TNGA160404-6N	TNGA331-6N		□□ST30S	6	9.525	3.81	4.76	0.4	
	160408-6N	332-6N							0.8	
	160412-6N	333-6N							1.2	

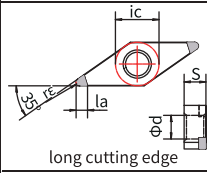
PCBN insert-Cast Iron

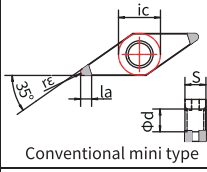
Tipped insert

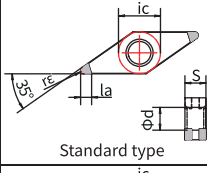
VN	35° rhombic-Negative-With hole
	PCBN Negative

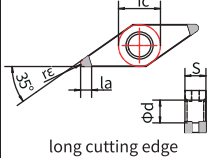
K					
Applications	○ ☺		⚙ ⚙		
Structure	SL	CB	SL	CB	
Material code	PNK0126	PNK0107	PNK0122	PNK3003	PNK3007 PNK3013
Cutting edge	S0102005 S0202010				
Coating	S/C3				





Shape	ISO	ANSI	Tips forming		Cutting edges	ic	φd	S	r	la
 <p>Conventional mini type</p>	VNGA160404-2N	VNGA331-2N		□□ST22S	2	9.525	3.81	4.76	0.4	2.2
	160408-2N	332-2N							0.8	
	160412-2N	333-2N							1.2	
 <p>Standard type</p>	VNGA160404-2N	VNGA331-2N		□□ST30S	2	9.525	3.81	4.76	0.4	3.0
	160408-2N	332-2N							0.8	
	160412-2N	333-2N							1.2	
 <p>long cutting edge</p>	VNGA160408-2N	VNGA332-2N		□□ST40S	2	9.525	3.81	4.76	0.8	4.0
	160412-2N	333-2N							1.2	
	160416-2N	334-2N							1.6	
 <p>Conventional mini type</p>	VNGA160404-4N	VNGA331-4N		□□ST22S	4	9.525	3.81	4.76	0.4	2.2
	160408-2N	332-4N							0.8	
	160412-4N	333-4N							1.2	
 <p>Standard type</p>	VNGA160404-4N	VNGA331-4N		□□ST30S	4	9.525	3.81	4.76	0.4	3.0
	160408-2N	332-4N							0.8	
	160412-4N	333-4N							1.2	
 <p>long cutting edge</p>	VNGA160408-4N	VNGA332-4N		□□ST40S	4	9.525	3.81	4.76	0.8	4.0
	160412-2N	333-4N							1.2	
	160416-4N	334-4N							1.6	

PCBN insert-Cast Iron

Tipped insert

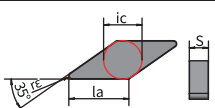
VN	35°rhombic-Negative-Solid
	PCBN Negative

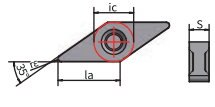
K		
Applications		
Structure	SS	SS
Material code	PNK0110 PNK0118	PNK3020
Cutting edge	E0000005 S0102005 S0202020	
Coating	S/C3	











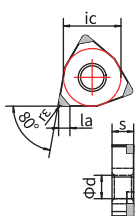

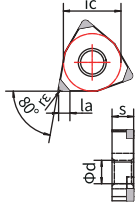
Shape	ISO	ANSI	Tips forming	Cutting edges	ic	φd	S	r	la
	VNGN160408-4N	VNGN332-4N		SSST160S	4	9.525	—	4.76	0.8
	160412-4N	333-4N							1.2
	160416-4N	334-4N							1.6
	VNGX160408-4N	VNGX332-4N		SSST160S	4	—	4.76	0.8	
	160412-4N	333-4N						1.2	
	160416-4N	334-4N						1.6	

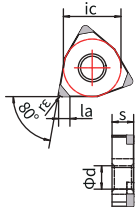
PCBN insert-Cast Iron

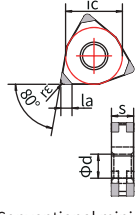
Tipped insert

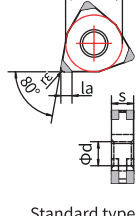
WN	80°hexagonal-Negative-With hole
	PCBN Negative

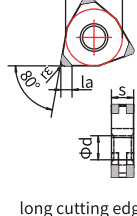

K					
Applications	○ ○		⚙ ⚙		
Structure	SL	CB	SL	CB	
Material code	PNK0126	PNK0107	PNK0122	PNK3003	PNK3007 PNK3013
Cutting edge	S0102005 S0202010				
Coating	S/C3				







Shape	ISO	ANSI	Tips forming	Cutting edges	ic	φd	S	r	la
 Conventional mini type	WNGA080404-3N	WNGA431-3N	 □□ST22S	3	12.7	5.16	4.76	0.4	2.2
	080408-3N	432-3N						0.8	
	080412-3N	433-3N	1.2						
	WNGA080404-3N	WNGA431-3N	 □□WGR22S	3				0.4	
	080408-3N	432-3N						0.8	
	080412-3N	433-3N	1.2						
 Standard type	WNGA080404-3N	WNGA431-3N	 □□ST30S	3	12.7	5.16	4.76	0.4	3.0
	080408-3N	432-3N						0.8	
	080412-3N	433-3N	1.2						
	WNGA080404-3N	WNGA431-3N	 □□WGR30S	3				0.4	
	080408-3N	432-3N						0.8	
	080412-3N	433-3N	1.2						
 long cutting edge	WNGA080408-3N	WNGA432-3N	 □□ST40S	3	12.7	5.16	4.76	0.8	4.0
	080412-3N	433-3N						1.2	
	080416-3N	434-3N	1.6						
	WNGA080408-3N	WNGA432-3N	 □□WGR40S	3				0.8	
	080412-3N	433-3N						1.2	
	080416-3N	434-3N	1.6						
 Conventional mini type	WNGA080404-6N	WNGA431-6N	 □□ST22S	6	12.7	5.16	4.76	0.4	2.2
	080408-6N	432-6N						0.8	
	080412-6N	433-6N	1.2						
	WNGA080404-6N	WNGA431-6N	 □□WGR22S	6				0.4	
	080408-6N	432-6N						0.8	
	080412-6N	433-6N	1.2						
 Standard type	WNGA080404-6N	WNGA431-6N	 □□ST30S	6	12.7	5.16	4.76	0.4	3.0
	080408-6N	432-6N						0.8	
	080412-6N	433-6N	1.2						
	WNGA080404-6N	WNGA431-6N	 □□WGR30S	6				0.4	
	080408-6N	432-6N						0.8	
	080412-6N	433-6N	1.2						
 long cutting edge	WNGA080408-6N	WNGA432-6N	 □□ST40S	6	12.7	5.16	4.76	0.8	4.0
	080412-6N	433-6N						1.2	
	080416-6N	434-6N	1.6						
	WNGA080408-6N	WNGA432-6N	 □□WGR40S	6				0.8	
	080412-6N	433-6N						1.2	
	080416-6N	434-6N	1.6						

PCBN insert-Cast Iron

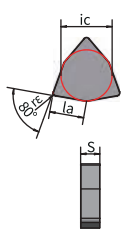
Tipped insert

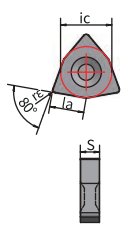
WN	80°hexagonal-Negative-Solid
	PCBN Negative

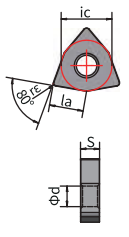
K		
Applications		
Structure	SS	SS
Material code	PNK0110 PNK0118	PNK3020
Cutting edge	E0000005 S0102005 S0202020	
Coating	S/C3	
Notes:PNK0118 offer a variety of inserts thinner than 4.76cm		







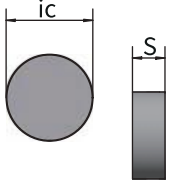

Shape	ISO	ANSI	Tips forming		Cutting edges	ic	φd	S	r	la
	WNGN080408-6N	WNGN432-6N		SSST80S	6	12.7	—	4.76	0.8	8
	080412-6N	433-6N							1.2	
	080416-6N	434-6N							1.6	
	WNGN080408-6N	WNGN432-6N		SSWGR80S	6	12.7	—	4.76	0.8	
	080412-6N	433-6N							1.2	
	080416-6N	434-6N							1.6	
	WNGX080408-6N	WNGX432-6N		SSST80S	6	12.7	—	4.76	0.8	8
	080412-6N	433-6N							1.2	
	080416-6N	434-6N							1.6	
	WNGX080408-6N	WNGX432-6N		SSWGR80S	6	12.7	—	4.76	0.8	
	080412-6N	433-6N							1.2	
	080416-6N	434-6N							1.6	
	WNGA080408-6N	WNGA432-6N		SSST80S	6	12.7	5.16	4.76	0.8	8
	080412-6N	433-6N							1.2	
	080416-6N	434-6N							1.6	
	WNGA080408-6N	WNGA432-6N		SSWGR80S	6	12.7	5.16	4.76	0.8	
	080412-6N	433-6N							1.2	
	080416-6N	434-6N							1.6	

PCBN insert-Cast Iron

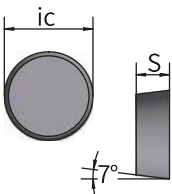
Tipped insert

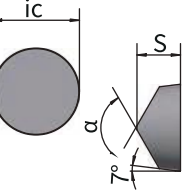
RN/RC	Circular-Solid
	PCBN Circular

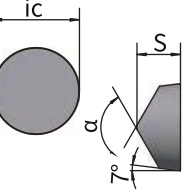

K			
Applications			
Structure	SS		SS
Material code	PNK0110	PNK0118	PNK3020
Cutting edge	E0000005 S0102005 S0202020		
Coating	S/C3		
Notes: PNK0118 offer a variety of inserts thinner than 4.76cm			









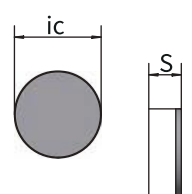

Shape	ISO	ANSI	Tips forming	Cutting edges	ic	φd	S	r	la
	RNGN060300	RNGN22		SSST64S	6.35	—	3.18	—	—
	RNGN090300	RNGN32		SSST95S	9.525		3.18		
	RNGN090400	RNGN33		SSST95S	9.525		4.76		
	RNGN120300	RNGN42		SSST127S	12.7		3.18		
	RNGN120400	RNGN43		SSST127S	12.7		4.76		
	RNGN120700	RNGN45		SSST127S	12.7		7.94		
	RNGN150700	RNGN55		SSST159S	15.875		7.94		
	RNGN190400	RNGN63		SSST190S	19.05		4.76		
	RNGN190700	RNGN65		SSST190S	19.05		7.94		
	RNGN200800	—		SSST200S	20		8		
	RNGN201000	—		SSST200S	20		10		
	RNGN250400	RNGN83		SSST254S	25.4		4.76		
	RNGN250700	RNGN85		SSST254S	25.4		7.94		
		RCGN0603MO		—			SSST60S		
RCGN060300		RCGN22	SSST64S	6.35		3.18			
RCGN090300		RCGN32	SSST95S	9.525		3.18			
RCGN090400		RCGN33	SSST95S	9.525		4.76			
RCGN120300		RCGN42	SSST127S	12.7		3.18			
RCGN120400		RCGN43	SSST127S	12.7		4.76			
RCGN120700		RCGN45	SSST127S	12.7		7.94			
	RCGX060400	RCGX23		SSST64S	6.35	—	4.76	—	—
	RCGX060500	RCGX2(3.5)		SSST64S	6.35		5.56		
	RCGX090400	RCGX33		SSST95S	9.525		4.76		
	RCGX100400	—		SSST100S	10		4.76		
	RCGX120700	RCGX45		SSST127S	12.7		7.94		
	RCGX150700	RCGX55		SSST190S	15.875		7.94		
	RCGX191000	—		SSST190S	19.05		10		
	RCGX201200	—		SSST200S	20		12		
		RCGX060400-V		RCGX23			SSST64S		
RCGX080400-V		—	SSST80S	8		4.76			

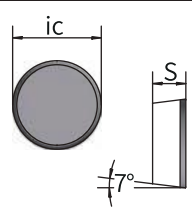
PCBN insert-Cast Iron

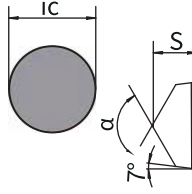
Tipped insert

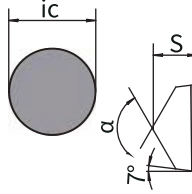
RN/RC	Circular-Full face
	PCBN Circular

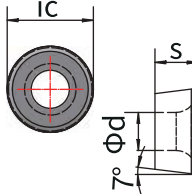
K		
Applications		
Structure	SS	SS
Material code	PNK0107	PNK3003 PNK3007
Cutting edge	E0000005 S0102005 S0202020	
Coating	S/C3	

Shape	ISO	ANSI	Tips forming		Cutting edges	ic	φd	S	r	la
	RNGN060300	RNGN22		SFST64S	—	6.35	—	3.18	—	—
	RNGN090300	RNGN32		SFST95S		9.525		3.18		
	RNGN090400	RNGN33		SFST95S		9.525		4.76		
	RNGN120300	RNGN42		SFST127S		12.7		3.18		
	RNGN120400	RNGN43		SFST127S		12.7		4.76		
	RNGN120700	RNGN45		SFST127S		12.7		7.94		
	RNGN150700	RNGN55		SFST159S		15.875		7.94		
	RCGN0603MO	—		SFST60S	—	6	—	3.18	—	—
	RCGN060300	RCGN22		SFST65S		6.35		3.18		
	RCGN090300	RCGN32		SFST95S		9.525		3.18		
	RCGN090400	RCGN33		SFST95S		9.525		4.76		
	RCGN120300	RCGN42		SFST127S		12.7		3.18		
	RCGN120400	RCGN43		SFST127S		12.7		4.76		
	RCGN120700	RCGN45		SFST127S		12.7		7.94		
	RCGX060400	RCGX23		SFST65S	—	6.35	—	4.76	—	—
	RCGX060500	RCGX2(3.5)		SFST65S		6.35		5.56		
	RCGX090400	RCGX33		SFST95S		9.525		4.76		
	RCGX100400	—		SFST100S		10		4.76		
	RCGX120700	RCGX45		SFST127S		12.7		7.94		
	RCGX060400-V	RCGX23		SFST65S	—	6.35	—	4.76	—	—
	RCGX080400-V	—		SFST80S		8		4.76		
	RCGW050200	RCGW(1.8)(1.5)		SFST56S	—	5.56	—	2.38	—	—
	RCGW060300	RCGW22		SFST64S		6.35		3.18		

PCBN insert-Powder Metallurgy

Tipped insert

CC	80° rhombic-Positive-With hole
	PCBN Positive

S			
Applications	○	◌	⊕ ⊗
Structure	SL	CB	CB
Material code	PNS0126	PNS0117	PNS2005 PNS2007 PNS2019
Cutting edge	E0000005 S0101505 S0153510		
Coating	S/C3		

Shape	ISO	ANSI	Tips forming	Cutting edges	ic	φd	S	r	la	
 <p>Conventional mini type</p>	CCGW060204-2N	CCGW2(1.5)1-2N		□□ST22S	6.35	2.8	2.38	0.4	2.2	
	060208-2N	2(1.5)2-2N						2		0.8
	CCGW060204-2N	CCGW2(1.5)1-2N		□□WGR22S				2		0.4
	060208-2N	2(1.5)2-2N						2		0.8
 <p>Standard type</p>	CCGW060204-2N	CCGW2(1.5)1-2N		□□ST30S	6.35	2.8	2.38	0.4	3.0	
	060208-2N	2(1.5)2-2N						2		0.8
	CCGW060204-2N	CCGW2(1.5)1-2N		□□WGR30S				2		0.4
	060208-2N	2(1.5)2-2N						2		0.8

CC	80° rhombic-Positive-With hole
	PCBN Positive

S			
Applications	○	◌	⊕ ⊗
Structure	SL	CB	CB
Material code	PNS0126	PNS0117	PNS2005 PNS2007 PNS2019
Cutting edge	E0000005 S0101505 S0153510		
Coating	S/C3		

Shape	ISO	ANSI	Tips forming	Cutting edges	ic	φd	S	r	la	
 <p>Conventional mini type</p>	CCGW09T304-2N	CCGW3(2.5)1-2N		□□ST22S	9.525	4.4	3.97	0.4	2.2	
	09T308-2N	3(2.5)2-2N						2		0.8
	CCGW09T304-2N	CCGW3(2.5)1-2N		□□WGR22S				2		0.4
	09T308-2N	3(2.5)2-2N						2		0.8
 <p>Standard type</p>	CCGW09T304-2N	CCGW3(2.5)1-2N		□□ST30S	9.525	4.4	3.97	0.4	3.0	
	09T308-2N	3(2.5)2-2N						2		0.8
	CCGW09T304-2N	CCGW3(2.5)1-2N		□□WGR30S				2		0.4
	09T308-2N	3(2.5)2-2N						2		0.8

PCBN insert-Powder Metallurgy

Tipped insert

CC	80° rhombic-Positive-With hole
	PCBN Positive

S			
Applications			
Structure	SL	CB	CB
Material code	PNS0126	PNS0117	PNS2005 PNS2007 PNS2019
Cutting edge	E0000005 S0101505 S0153510		
Coating	S/C3		

Shape	ISO	ANSI	Tips forming	Cutting edges	ic	φd	S	r	la	
<p>Conventional mini type</p>	CCGW120404-2N	CCGW431-2N		□□ST22S	12.7	5.5	4.76	0.4	2.2	
	120408-2N	432-2N		□□WGR22S				2		0.8
	CCGW120404-2N	CCGW431-2N		□□ST30S				2		0.4
	120408-2N	432-2N		□□WGR30S				2		0.8
<p>Standard type</p>	CCGW120404-2N	CCGW431-2N		□□ST30S	12.7	5.5	4.76	0.4	3.0	
	120408-2N	432-2N		□□WGR30S				2		0.8
	CCGW120404-2N	CCGW431-2N		□□ST30S				2		0.4
	120408-2N	432-2N		□□WGR30S				2		0.8

DC	55° rhombic-Positive-With hole
	PCBN Positive

S			
Applications			
Structure	SL	CB	CB
Material code	PNS0126	PNS0117	PNS2005 PNS2007 PNS2019
Cutting edge	E0000005 S0101505 S0153510		
Coating	S/C3		





Shape	ISO	ANSI	Tips forming	Cutting edges	ic	φd	S	r	la	
<p>Conventional mini type</p>	DCGW070204-2N	DCGW2(1.5)1-2N		□□ST22S	6.35	2.8	2.38	0.4	2.2	
	070208-2N	2(1.5)2-2N		□□WGR22S (107.5°)				2		0.8
	DCGW070204-2N	DCGW2(1.5)1-2N		□□ST30S				2		0.4
	070208-2N	2(1.5)2-2N		□□WGR30S (107.5°)				2		0.8
<p>Standard type</p>	DCGW070204-2N	DCGW2(1.5)1-2N		□□ST30S	6.35	2.8	2.38	0.4	3.0	
	070208-2N	2(1.5)2-2N		□□WGR30S (107.5°)				2		0.8
	DCGW070204-2N	DCGW2(1.5)1-2N		□□ST30S				2		0.4
	070208-2N	2(1.5)2-2N		□□WGR30S (107.5°)				2		0.8

PCBN insert-Powder Metallurgy

Tipped insert

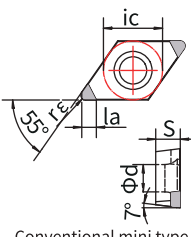
DC	55° rhombic-Positive-With hole
	PCBN Positive

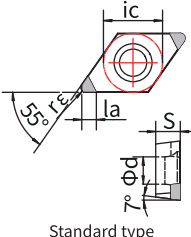
S			
Applications	○	◐	⊕ ⊗
Structure	SL	CB	CB
Material code	PNS0126	PNS0117	PNS2005 PNS2007 PNS2019
Cutting edge	E0000005 S0101505 S0153510		
Coating	S/C3		





Shape	ISO	ANSI	Tips forming	Cutting edges	ic	φd	S	r	la
 <p>Conventional mini type</p>	DCGW11T304-2N	DCGW3(2.5)1-2N		□□ST22S	9.525	4.4	3.97	0.4	2.2
	11T308-2N	3(2.5)2-2N						0.8	
	DCGW11T304-2N	DCGW3(2.5)1-2N		□□WGR22S (107.5°)				0.4	
	11T308-2N	3(2.5)2-2N						0.8	
 <p>Standard type</p>	DCGW11T304-2N	DCGW3(2.5)1-2N		□□ST30S	9.525	4.4	3.97	0.4	3.0
	11T308-2N	3(2.5)2-2N						0.8	
	DCGW11T304-2N	DCGW3(2.5)1-2N		□□WGR30S (107.5°)				0.4	
	11T308-2N	3(2.5)2-2N						0.8	

PCBN insert-Powder Metallurgy

Tipped insert

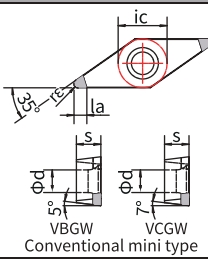
VB/VC	35°rhombic-Positive-With hole
	PCBN Positive

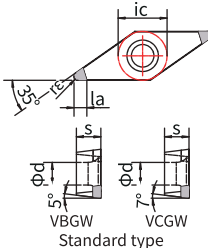
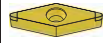
S			
Applications	○	⊕	⚙️ ⚙️
Structure	SL	CB	CB
Material code	PNS0126	PNS0117	PNS2005 PNS2007 PNS2019
Cutting edge	E0000005 S0101505 S0153510		
Coating	S/C3		











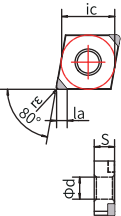



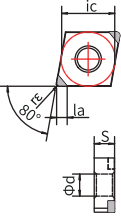



Shape	ISO	ANSI	Tips forming		Cutting edges	ic	φd	S	r	la
 <p>VBGW VCGW Conventional mini type</p>	VBGW160404-2N	VBGW331-2N		□□ST22S	2	9.525	4.4	4.76	0.4	2.2
	160408-2N	332-2N							0.8	
	VCGW160404-2N	VCGW331-2N		□□ST22S	2				0.4	
	160408-2N	332-2N							0.8	
 <p>VBGW VCGW Standard type</p>	VBGW160404-2N	VBGW331-2N		□□ST30S	2	9.525	4.4	4.76	0.4	3.0
	160408-2N	332-2N							0.8	
	VCGW160404-2N	VCGW331-2N		□□ST30S	2				0.4	
	160408-2N	332-2N							0.8	

PCBN insert-Powder Metallurgy

Tipped insert

CN	80° rhombic-Negative-With hole
	PCBN Negative

S			
Applications	○	◐	⊞ ⊞
Structure	SL	CB	CB
Material code	PNS0126	PNS0117	PNS2005 PNS2007 PNS2019
Cutting edge	E0000005 S0101505 S0153510		
Coating	S/C3		

Shape	ISO	ANSI	Tips forming	Cutting edges	ic	φd	S	r	la	
 Conventional mini type	CNGA120404-2N	CNGA431-2N		□□ST22S	2	12.7	5.16	4.76	0.4	2.2
	120408-2N	432-2N		□□ST22S					0.8	
	CNGA120404-2N	CNGA431-2N		□□WGR22S	2				0.4	
	120408-2N	432-2N		□□WGR22S	2				0.8	
 Standard type	CNGA120404-2N	CNGA431-2N		□□ST30S	2	12.7	5.16	4.76	0.4	3.0
	120408-2N	432-2N		□□ST30S					2	
	CNGA120404-2N	CNGA431-2N		□□WGR30S	2				0.4	
	120408-2N	432-2N		□□WGR30S	2				0.8	
 Conventional mini type	CNGA120404-4N	CNGA431-4N		□□ST22S	4	12.7	5.16	4.76	0.4	2.2
	120408-4N	432-4N		□□ST22S					4	
	CNGA120404-4N	CNGA431-4N		□□WGR22S	4				0.4	
	120408-4N	432-4N		□□WGR22S	4				0.8	
 Standard type	CNGA120404-4N	CNGA431-4N		□□ST30S	4	12.7	5.16	4.76	0.4	3.0
	120408-4N	432-4N		□□ST30S					4	
	CNGA120404-4N	CNGA431-4N		□□WGR30S	4				0.4	
	120408-4N	432-4N		□□WGR30S	4				0.8	

PCBN insert-Powder Metallurgy

Tipped insert

DN	55°rhombic-Negative-With hole
	PCBN Negative

S			
Applications	○	⊖	⚙️ ⚙️
Structure	SL	CB	CB
Material code	PNS0126	PNS0117	PNS2005 PNS2007 PNS2019
Cutting edge	E0000005 S0101505 S0153510		
Coating	S/C3		





Shape	ISO	ANSI	Tips forming		Cutting edges	ic	φd	S	r	la
	DNGA150404-2N	DNGA431-2N		□□ST22S	2	12.7	5.16	6.35	0.4	2.2
	150408-2N	432-2N							0.8	
	DNGA150404-2N	DNGA431-2N		□□WGR22S (107.5°)	2				0.4	
	150408-2N	432-2N							0.8	
	DNGA150404-2N	DNGA431-2N		□□ST30S	2	12.7	5.16	6.35	0.4	3.0
	150408-2N	432-2N							0.8	
	DNGA150404-2N	DNGA431-2N		□□WGR30S (107.5°)	2				0.4	
	150408-2N	432-2N							0.8	
<p>Conventional mini type</p>	DNGA150404-4N	DNGA431-4N		□□ST22S	4	12.7	5.16	6.35	0.4	2.2
	150408-4N	432-4N							0.8	
	DNGA150404-4N	DNGA431-4N		□□WGR22S (107.5°)	4				0.4	
	150408-4N	432-4N							0.8	
<p>Standard type</p>	DNGA150404-4N	DNGA431-4N		□□ST30S	4	12.7	5.16	6.35	0.4	3.0
	150408-4N	432-4N							0.8	
	DNGA150404-4N	DNGA431-4N		□□WGR30S (107.5°)	4				0.4	
	150408-4N	432-4N							0.8	

PCBN insert-Powder Metallurgy

Tipped insert

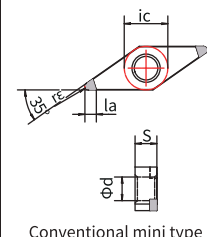
VN	35° rhombic-Negative-With hole
	PCBN Negative

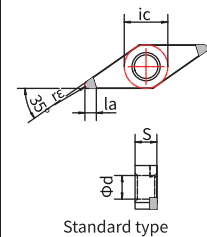
S			
Applications	○	◐	⊕ ⊗
Structure	SL	CB	CB
Material code	PNS0126	PNS0117	PNS2005 PNS2007 PNS2019
Cutting edge	E0000005 S0101505 S0153510		
Coating	S/C3		

Shape	ISO	ANSI	Tips forming	Cutting edges	ic	φd	S	r	la
 <p>Conventional mini type</p>	VNGA160404-2N	VNGA331-2N		□□ST22S	9.525	3.81	4.76	0.4	2.2
	160408-2N	332-2N						0.8	
	VNGA160404-4N	VNGA331-4N		□□ST22S	4	0.4			
	160408-4N	332-4N			0.8				
 <p>Standard type</p>	VNGA160404-2N	VNGA331-2N		□□ST30S	9.525	3.81	4.76	0.4	3.0
	160408-2N	332-2N						0.8	
	VNGA160404-4N	VNGA331-4N		□□ST30S	4	0.4			
	160408-4N	332-4N			0.8				

Insert Wear Causes and Solutions

wear on the rake face, breakage of the cutting edge, crescent wear, chipping

■ Wear on the rake face

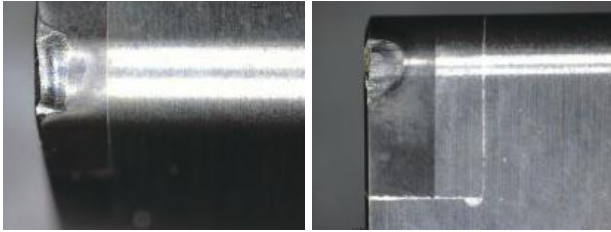

Causes: Excessive cutting speed

Insufficient wear resistance of the material

Low Feed rate

Solutions: Reduce cutting speed

Select a material with higher wear resistance

Adjust the feed to match the cutting speed and depth
(increase the feed)

■ Breakage of the cutting edge



Causes: Hard material

Vibration

Excessive feed rate or cutting depth

Interrupted cutting

Chip damage

Solutions: Reduce cutting speed

Select a material with higher wear resistance

Adjust the feed to match the cutting speed and depth
(increase the feed)

■ Crescent wear

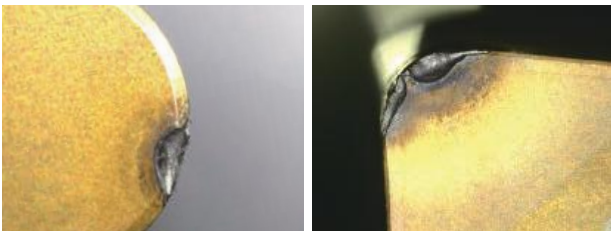

Causes: Excessive cutting speed and/or feed rate

Insufficient wear resistance of the material

Insufficient coolant supply

Solutions: Reduce cutting speed and/or feed rate

Optimize the coolant supply by increasing the coolant
flow and pressure

Use a material with higher wear resistance for crescent

■ Chipping

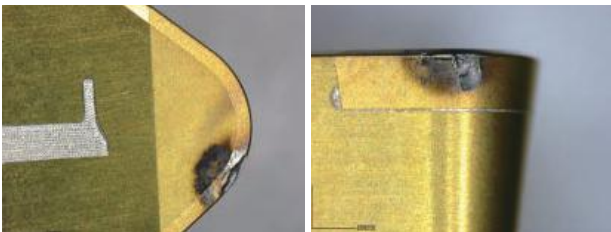

Causes: Excessive pressure on inserts

Insufficient stability

Small corners

Excessive breakage at the cutting depth of the edge

Solutions: Use tougher materials

Use chamfered inserts

Increase the corners of the inserts

Dry/ Wet Cutting Recommendation

Dry/ Wet Cutting

The coolant plays a lubricating and cooling role when cutting with PCBN tools, minimizing heat damage to the insert. This is especially important during continuous high-speed cutting under heavy loads. However, during interrupted cutting, the use of coolant can create thermal stress on the inserts and lead to cracking. Therefore, it is recommended to use dry cutting for interrupted cutting.

Spindle Speed Recommendation

Cutting speed—Workpiece/Tool Diameter

Cutting speed Vc(m/min)	Workpiece/Tool Diameter (mm)													
	12	16	20	25	32	50	63	80	100	125	160	175	200	250
80	2123	1592	1274	1019	796	510	404	318	255	204	159	146	127	102
90	2389	1791	1433	1146	896	573	455	358	287	229	179	164	143	115
100	2654	1990	1592	1274	995	637	506	398	318	255	199	182	159	127
110	2919	2189	1752	1401	1095	701	556	438	350	280	219	200	175	140
120	3185	2389	1911	1529	1194	764	607	478	382	306	239	218	191	153
140	3715	2787	2229	1783	1393	892	708	557	446	357	279	255	223	178
160	4246	3185	2548	2038	1592	1019	809	637	510	408	318	291	255	204
180	4777	3583	2866	2293	1791	1146	910	717	573	459	358	328	287	229
200	5308	3981	3185	2548	1990	1274	1011	796	637	510	398	364	318	255
220	5839	4379	3503	2803	2189	1401	1112	876	701	561	438	400	350	280
240	6369	4777	3822	3057	2389	1529	1213	955	764	611	478	437	382	306
260	6900	5175	4140	3312	2588	1656	1314	1035	828	662	518	473	414	331
280	7431	5573	4459	3567	2787	1783	1415	1115	892	713	557	510	446	357
300		5971	4777	3822	2986	1911	1517	1194	955	764	597	546	478	382
400						2548	2022	1592	1274	1019	796	728	637	510
600						3822	3033	2389	1911	1529	1194	1092	955	764
800						5096	4044	3185	2548	2038	1592	1456	1274	1019
1000						6369	5055	3981	3185	2548	1990	1820	1592	1274

Cutting Direction Recommendation

Recommended cutting direction for turning hardened steel with PCBN tools

External machining

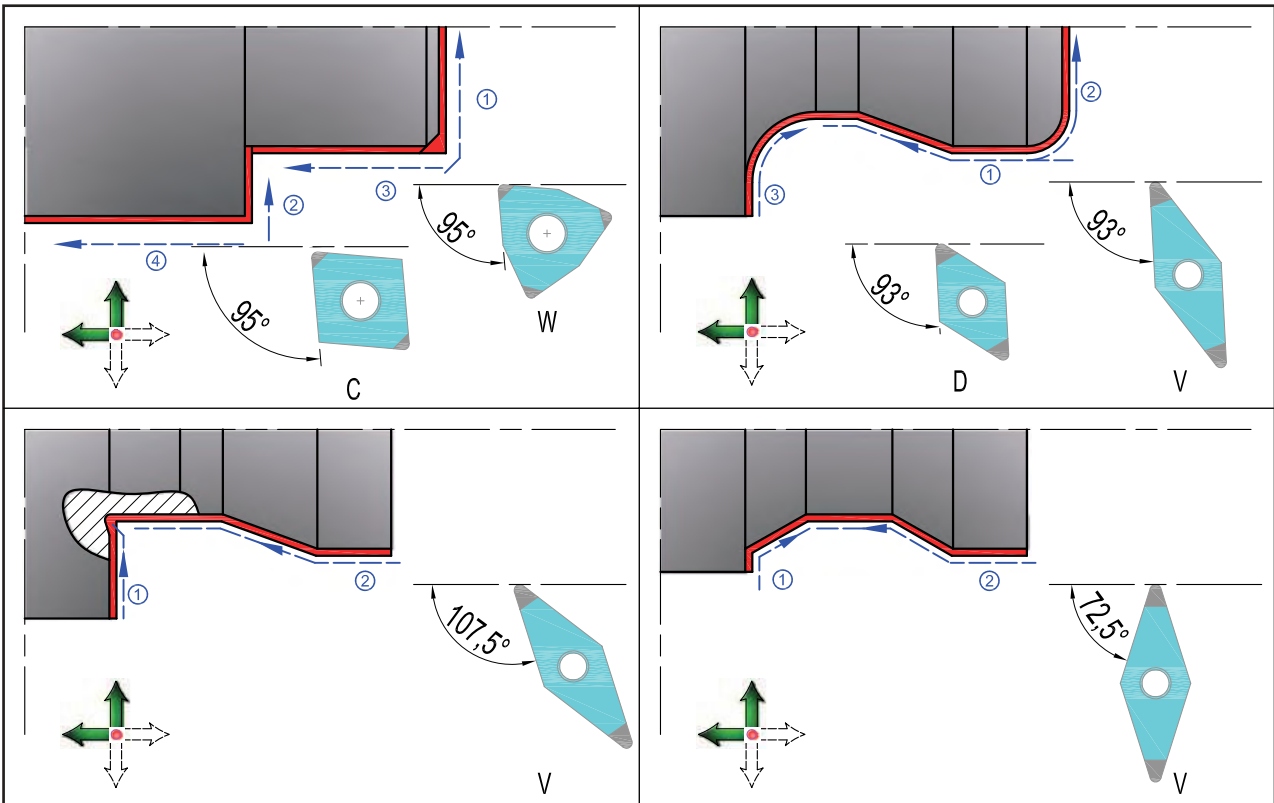

Internal machining

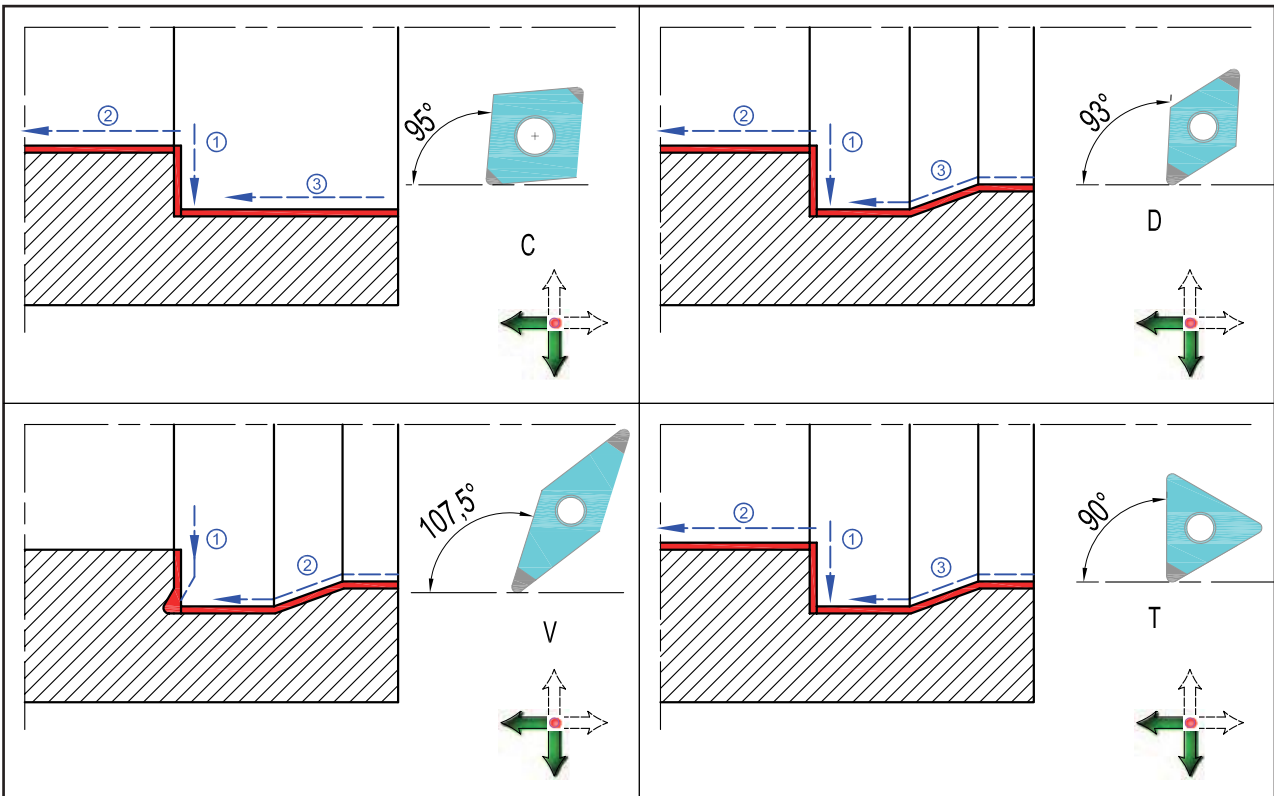

Comparison Table of Metal Material

Steel grade comparison table

Steel grade comparison table						
Description	China	Japan	America	England	Germany	France
	GB	JIS	AISI/SAE	BS	DIN	NF
Carbon Steel	08 10	S10C	1010	040A10 045A10 045M10	C10E C10R	XC10
		S12C	1012	040A12		XC12
	15	S15C	1015	055M15	C15E C15R	
		S17C	1017			XC18
	20	S20C	1020	070M20 C22 C22E C22R	C22 C22E C22R	C22 C22E C22R
		S22C	1023			
	25	S25C	1025	C25 C25E C22R	C25 C25E C22R	C25 C25E C22R
		S28C	1029			
	30	S30C	1030	080A30 080M30 C30 C30E C30R	C30 C30E C30R	C30 C30E C30R
		S33C				
	35	S35C	1035	C35 C35E C35R	C35 C35E C35R	C35 C35E C35R
		S38C	1038			
	40	S40C	1039 1040	080M40 C40 C40E C40R	C40 C40E C40R	C40 C40E C40R
		S43C	1042 1043	080A42		
	45	S45C	1045 1046	C45 C45E C45R	C45 C45E C45R	C45 C45E C45R
		S48C		080A47		
	50	S50C	1049	080M50 C50 C50E C50R	C50 C50E C50R	C50 C50E C50R
		S53C	1050 1053			
	55	S55C	1055	070M55 C55 C55E	C55 C55E C55R	C55 C55E C55R
	60	S58C	1059 1060	C55R C60 C60E	C60 C60E	C60 C60E
	S09CK		C60R 045A10	C60R C10E	C60R XC10	
			045M10			
15F	S15CK			C15E	XC12	
	S20CK				XC18	

Comparison Table of Metal Material

Steel grade comparison table

Steel grade comparison table						
Description	China	Japan	America	England	Germany	France
	GB	JIS	AISI/SAE	BS	DIN	NF
Ni-Cr Steel		SNC236			36NiCr6	
	12CrNi2	SNC415			14NiCr10	
	30CrNi3	SNC631			36NiCr10	
	12Cr2Ni4	SNC815		655M13	15NiCr13	
	37CrNi3	SNC836			31NiCr14	
Ni-Cr-Mo Steel	20CrNiMo	SNCM220	8615 8617 8620 8622	805A20 805M20 805A22 805M22	20NiCrMo2 20NiCrMoS2	20NCD 2
		SNCM240	8637 8640		40NiCrMo2-2	
		SNCM415				
	18CrNiMnMoA	SNCM420	4320		17NiCrMo6-4	
		SNCM431			30CrNiMo8	
	40CrNiMoA	SNCM439	4340		40NiCrMo6	
		SNCM447			34CrNiMo6	
		SNCM616				
		SNCM625				
	SNCM630					
	SNCM815					
Chromium Steel	15Cr 15GrA	SCr415			17Cr3 17CrS3	
	20Cr	SCr420	5120			
	30Cr	SCr430	5130 5132	34Cr4 34CrS4	34Cr4 34CrS4	34Cr4 34CrS4
	35Cr	SCr435	5132	37Cr4 37CrS4	37Cr4 37CrS4	37Cr4 37CrS4
	40Cr	SCr440	5140	530M40 41Cr4 41CrS4	41Cr4 41CrS4	41Cr4 41CrS4
	45Cr 50Cr	SCr445				
Cr-Mo Steel	15CrMo	SCM415			15CrMo4	
	20CrMo	SCM418			18CrMo4 18CrMoS4	
		SCM420		708M20	20CrMo5	
		SCM421				
	30CrMo 30CrMoA	SCM430	4130			
		SCM432				
	35CrMo	SCM435	4137	34CrMo4 34CrMoS4	34CrMo4 34CrMoS4	34CrMo4 34CrMoS4
	42CrMo	SCM440	4140 4142	708M40 709M40 42CrMo4 42CrMoS4	42CrMo4 42CrMoS4	42CrMo4 42CrMoS4
		SCM445	4145 4147			
	SCM822					

Comparison Table of Metal Material

Steel grade comparison table

Steel grade comparison table						
Description	China	Japan	America	England	Germany	France
	GB	JIS	AISI/SAE	BS	DIN	NF
Mn-Cr Steel	20Mn2	SMn420	1522	150M19	20Mn5	
	30Mn2 35Mn2	SMn433	1536	150M36	34Mn5	
	40Mn2	SMn438	1541	150M36	36Mn5	
	45Mn2	SMn443	1541			
	15CrMn	SMnC420	5115		16MnCr5	
	40GrMn	SMnC443	5140			
Hardened Steel		SMn420H	1522H			
		SMn433H				
		SMn438H	1541H			
		SMn443H	1541H			
		SMnC420H				
		SMnC443H				
	15Cr1H	SCr415H			17Cr3 17CrS3	
	20Cr1H	SCr420H	5120H		17Cr3	
		SCr430H	5130H 5132H	34Cr4 34CrS4	34Cr4 34CrS4	34Cr4 34CrS4
		SCr435H	5135H	37Cr4 37CrS4	37Cr4 37CrS4	37Cr4 37CrS4
	40CrH	SCr440H	5140H	41Cr4 41CrS4	41Cr4 41CrS4	41Cr4 41CrS4
	15CrMoH	SCM415H	4118H		15CrMo5	
		SCM418H			18CrMo4 18CrMoS4	
	20CrMoH	SCM420H	4118H	708H20	18CrMo4	
		SCM435H	4135H 4137H	34CrMo4 34CrMoS4	34CrMo4 34CrMoS4	34CrMo4 34CrMoS4
	42CrMoH	SCM440H	4140H 4142H	42CrMo4 42CrMoS4	42CrMo4 42CrMoS4	42CrMo4 42CrMoS4
		SCM445H	4145H 4147H			
		SCM822H				
		SNC415H				
		SNC631H				
12Cr2Ni4H	SNC815H			655H13	15NiCr13	
20CrNiMoH	SNCM220H	8617H 8620H 8622H	805H17 805H20 805H22	21NiCrMo2	20N CD 2	
20CrNi2MoH	SNCM420H	4320H		20NiCrMoS6-4		
SGP	GCr4	SUJ1	51100			
	GCr15	SUJ2	52100		100Cr6	100Cr6
	GCr15SiMn	SUJ3	ASTM A 485 Grade 1			
	GCr15SiMo	SUJ4				
	GCr18Mo	SUJ5				

Comparison Table of Metal Material

Steel grade comparison table

Cast iron grade comparison table						
Description	China	Japan	America	England	Germany	France
	GB	JIS	AISI/SAE	BS	DIN	NF
Grey Iron	HT100	FC100	NO.20	100	GG10	
	HT150	FC150	NO.30	150	GG15	FGL150
	HT200	FC200	NO.35	200	GG20	FGL200
	HT250	FC250	NO.45	250	GG25	FGL250
	HT300	FC300	NO.50	300	GG30	FGL300
	HT350	FC350	NO.60	350	GG35	FGL350
					GG40	FGL400
Ductile Iron	QT400-18	FCD400	60-40-18	400/17	GGG40	FGS370-17
	QT450-10	FCD450	65-45-12	420/12		FGS400-12
	QT500-7	FCD500	70-50-05	500/7	GGG50	FGS500-7
	QT600-3	FCD600	80-60-03	600/7	GGG60	FGS600-2
	QT700-2	FCD700	100-70-03	700/2	GGG70	FGS700-2
	QT800-2	FCD800	120-90-02	800/2	GGG80	FGS800-2
	QT900-2			900/2		

Precautions of How to Use Turning Tools

Hazard and Countermeasure

Products	Hazard	Countermeasure
All Turning Tools	Cutting tools have sharp cutting edges, which may cause injury if handled	※Take precautions such as wearing gloves especially when handling tools and during installation
	Improper use of tools and application of inappropriate cutting conditions may cause the tool to break and be expelled from the machine providing risk of injury.	※Ensure safety guards and goggles are used ※Use tools under recommended cutting conditions ※Refer to handling explanatory notes and catalogues
	Impact load and rapid increase of cutting resistance due to excessive wear may cause the tool to break and be expelled from the machine providing risk of injury.	※Wear personal protective equipment when using tools, e.g. gloves and safety glasses ※Replace tools timely
	Expelled hot chips produced in cutting produces risk of injuries and burns	※Wear personal protective equipment when using tools, e.g. gloves and safety glasses ※During swarf removal and machine cleaning ensure the machine is stopped and wear gloves. Please use tools under safety circumstance.
	Cutting tools and workpieces become extremely hot during cutting. Touching them with bare hands may cause burns	※Wear personal protective equipment when using tools, e.g. gloves and safety glasses
	Sparks, hot chips and heat generation during cutting caused by tool breakage provides a risk of igniting a fire	※Do not use in places where there is a danger of flammability or explosion ※Take fire prevention measures when using non-water soluble cutting tools
	Using machines, chucks, and tools with poor balance at high revolutions may cause tools to break providing risk of injuries	※Ensure safety guards and goggles are used ※Be sure there is no vibration or unusual noise before starting the operation
	Handling machined parts with burrs using bare hands may cause injuries	※Do not touching them with bare hands
Welding and Clamping Tools	If inserts and spare parts are not held securely, they may become loose and be expelled producing risk of injuries	※Ensure inserts are brazed securely before using tools. ※Do not use them under conditions which produce very high temperature over melting point
	The inserts are in danger of damaging after several brazes	※Use them strictly for the prescribed application
	Machinery or tools may break if used in applications not recommended by the manufacturer	※Use them strictly for the prescribed application
	If the inserts are not securely fastened during machining, there is a risk of it becoming loose, damaged, or unusable.	※Ensure that there are no foreign objects present before installing the inserts. ※Confirm stability and use only the tools prescribed application by the manufacturer.
	Clamping inserts and spare parts too tightly by using tools such as extension pipes may cause them to break and be expelled	※Do not use any auxiliary tool such as extension pipes ※Please use the suitable wrench
	When applying high cutting speed, spare parts and inserts may be expelled due to centrifugal force. Pay special attention to safety	※Use tools under recommended cutting conditions ※Refer to handling explanatory notes and catalogues

NOTE: This catalogue provides essential safety precautions for the proper use of our company's products.

For further information, please refer to the guideline, catalogues or contact support team. We are not responsible for any accidents from the any unauthorized modifications.



Indexable PCD and PCBN Milling Cutters





MANANOVA[®] Standard Program

Easy Choice – Fast Delivery

MANANOVA is the name for Worldia's stock-keeping standard product portfolio. It provides best-in-class high-quality products within a wide range of most-common applications at very attractive prices.

Each item has an inventory code which simplifies the order process.

MANANOVA products will be delivered directly from our warehouses to any global destination within max. 1 week.

MANANOVA product range currently covers PCD and PCBN ISO inserts as well as indexable PCD and PCBN milling cutters with associated inserts.



Worldia PCD and PCBN Indexable Milling Cutters Product Selection

	Shell Milling Cutters - Fine Pitch	Shell Milling Cutters - Light Weight/ Coarse Pitch	Shank and Screw-On Milling Cutters	Disc Milling Cutters	Shell Milling Cutters
Specification	FMP-BE	FMP-BE	FMP-BE	FMP-BE	FMP-SD
Picture					
Processes	Face + Shoulder Milling  	Face + Shoulder Milling  	Face + Shoulder Milling  	Side Milling LH, RH, Slotting   	Face Milling 
Workpiece Material	N K H	N K H	N K H	N K H	K H
Cutting Material	PCD/PCBN	PCD/PCBN	PCD/PCBN	PCD/PCBN	PCBN
Insert Type	BEHW1204	BEHW1204	BEHW1204	BEHW1204	SDHN07T3
Cutting Edges/ Insert	1 or 2	1 or 2	1 or 2	1 or 2	4
Max. DOC/ Ap (mm)	11	11	11	11/21	0.5
Standard Cutter Diameter (mm)	40 - 250	80 - 160	25 - 32	100 - 200	50 - 250
Cutter Material	40 - 63: Steel 80 - 250: Aluminium + Steel	Aluminium + Steel	Steel	Steel	Steel
Lead Angle	90°	90°	90°	90°	88°
Axially Adjustable	Yes, 2 µm within 0,1 mm range	Yes, 2 µm within 0,1 mm range	Yes, 2 µm within 0,1 mm range	Yes, 2 µm within 0,1 mm range	Yes, 5 µm within 0,3 mm range
Adjustable Tooth Number	All	All	All	All	All
Fix Pocket Runout (mm)	0,02 - 0,04	0,02 - 0,04	0,02 - 0,04	0,02 - 0,04	0,02 - 0,04
HSC Capability	Yes	Yes	Yes	Yes	Yes
Internal Coolant	Yes	Yes	Yes	Yes	Yes
Standard	ISO, INCH	ISO	ISO	ISO	ISO
Page Cutters	7 - 8	9	10	11	15
Page Inserts	21-23	21-23	21-23	21-23	24

Worldia FMP-BE Indexable Milling Cutters

High-speed cutting with highest precision and lowest weight



Main Applications

Worldia FMP-BE Milling Cutters were developed for high-speed machining of light metal on even small-size machining centers with precision spindles.

Thanks to innovative Bimetal Aluminium/ Steel body design, requirements for low weight, low inertia and precise balancing to allow high spindle acceleration, high strength and wear resistance are met at the same time.

Cutters from diameter 80 to 160 mm can be mounted to the same adaptor, whereas e.g. the weight of a diameter 160 mm cutter with BT30 adaptor does not exceed 3 kg.

All Worldia FMP-BE cutters have 1 standard insert pocket that allows usage of different combinations of BEHW1204 PCD- and PCBN-tipped inserts, adjustable or non-adjustable, for a comprehensive range of roughing and finishing applications including hatch milling.

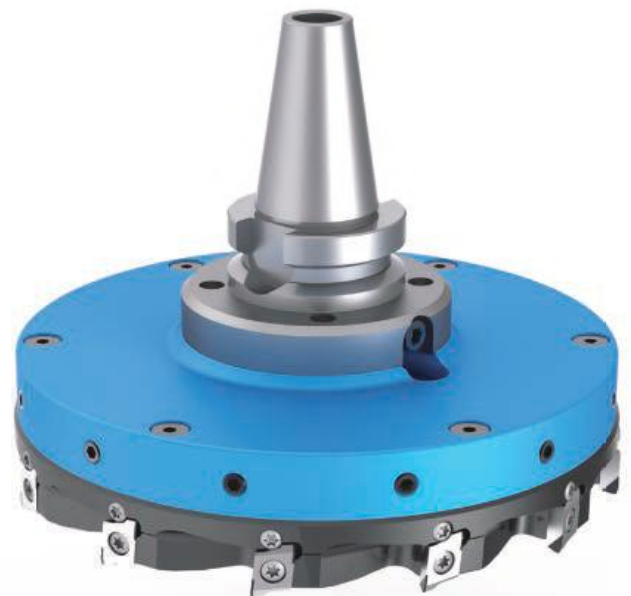

Worldia FMP-BE Indexable Milling Cutters

High-speed cutting with highest precision and lowest weight

Design Features

- Aluminium Alloy/ Steel Bimetal design
 - Al center body for weight reduction
 - Hardened Steel ring for high rigidity and wear resistance, therefore longer cutter life versus cutters with Aluminium body
- High precision insert pocket seats keeping 0,02 mm axial runout without insert adjustment
- As a standard, each pocket can also be adjusted to 2 μm axial runout within a 0,1 mm range
- BEHW inserts are available in a variety of cutting materials, lead angles, wiper and corner designs for many different applications in face and shoulder milling, roughing and finishing
- Separation between insert positioning face and cutting edge to protect cutting edge and to simplify the use of relapped or retipped inserts
- Inserts with 2 cutting edges and relap/ retip service to reduce tooling cost per part
- Internal coolant through the cutter body

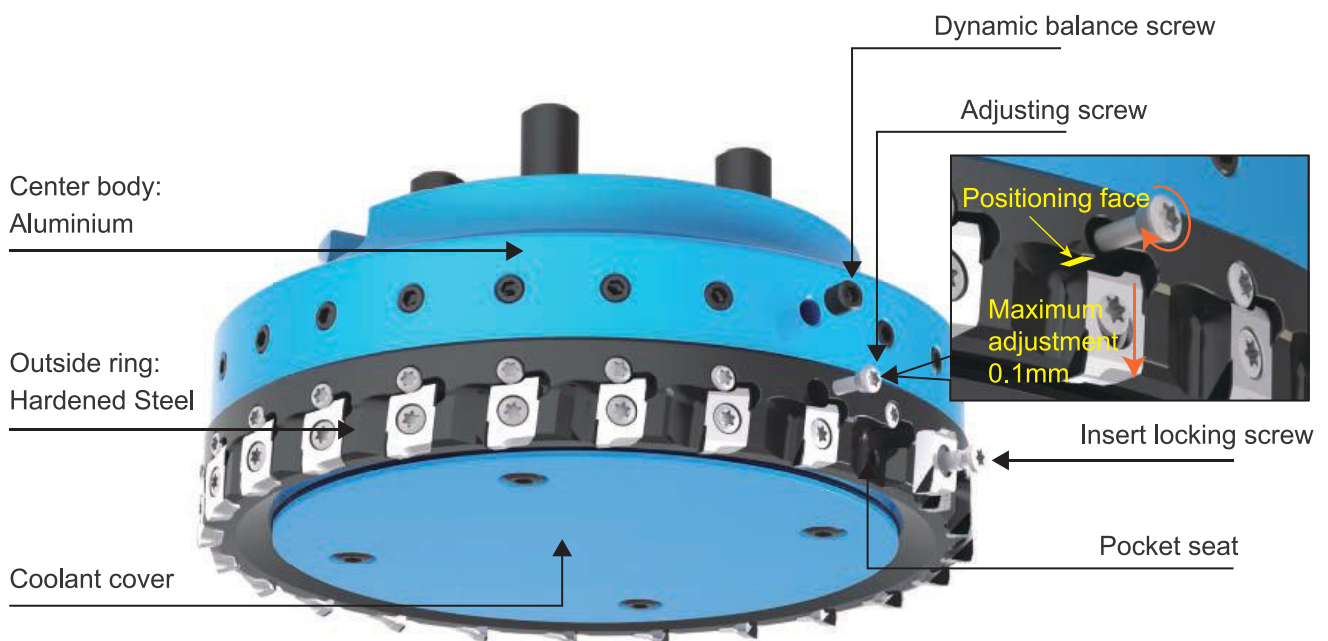
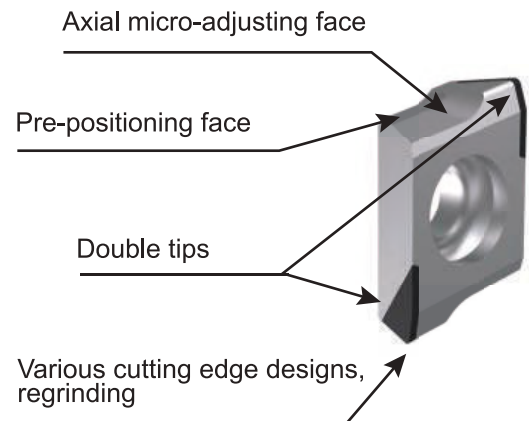

FMP-BE Shell Milling Cutters – Fine Pitch

ISO **MANANOVA** Easy Choice – Fast Delivery

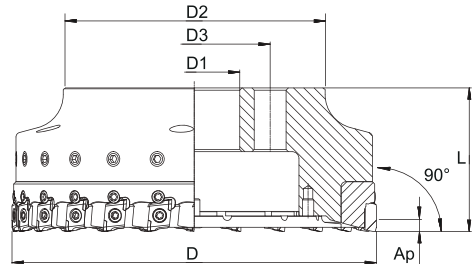

Inventory	
Code	In stock, MANANOVA
○	Made to order

ISO

Inserts see page 21-23

Specification	Inventory	D	D1	D2	D3	L	Ap max	Z	kg	max RPM	Material
FMP040SA16-BE12-06	040401060013	40	16	36	—	40	11	6	0.36	40000	Steel
FMP050SA22-BE12-08	040401060005	50	22	45	—	40	11	8	0.55	35100	Steel
FMP063SA22-BE12-10	040401060006	63	22	45	—	40	11	10	0.75	30200	Steel
FMP080SA27-BE12-12	040401060007	80	27	50	—	50	11	12	0.96	27500	Steel+Aluminium
FMP100SB32-BE12-16	040401060008	100	32	70	—	50	11	16	1.45	23800	Steel+Aluminium
FMP125SB40-BE12-20	040401060009	125	40	90	—	63	11	20	2.40	19100	Steel+Aluminium
FMP160SC40-BE12-24	040401060010	160	40	115	66.7	63	11	24	3.00	14900	Steel+Aluminium
FMP200SC60-BE12-30	040401060011	200	60	150	101.6	63	11	30	4.25	11900	Steel+Aluminium
FMP250SC60-BE12-36	040401060012	250	60	200	101.6	63	11	36	6.50	9550	Steel+Aluminium

Cutters delivered assembled with spare parts, but without inserts, dynamically balanced to G2.5 at 25000 RPM

unit: mm

Spare Parts

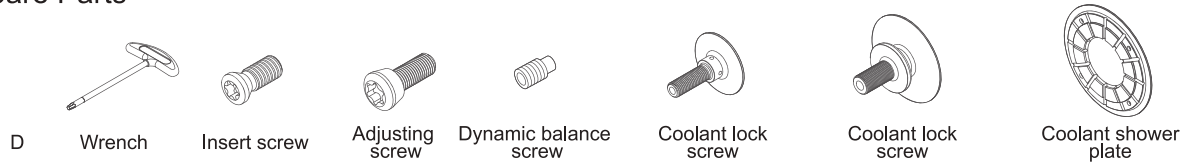

D	Wrench	Insert screw	Adjusting screw	Dynamic balance screw	Coolant lock screw	Coolant lock screw	Coolant shower plate
40	15IP	S40120J	S30110G	0204010265	FMP040SA16-BE12-06.02	—	—
50	15IP	S40120J	S30110G	0204010265	FMP050SA22-BE12-08.02	—	—
63	15IP	S40120J	S30110G	0204010265	FMP063SA22-BE12-10.02	—	—
80	15IP	S40120J	S30110G	B03400252	FMP080SA27-BE12-12.03	—	—
100	15IP	S40120J	S30110G	B03400252	—	FMP100SB32-BE12-16.03	—
125	15IP	S40120J	S30110G	B03400252	—	FMP125SB40-BE12-20.03	—
160	15IP	S40120J	S30110G	B03400252	—	—	FMP160SC40-BE12-24.03
200	15IP	S40120J	S30110G	B03400252	—	—	FMP200SC60-BE12-30.03
250	15IP	S40120J	S30110G	B03400252	—	—	FMP250SC60-BE12-36.03

FMP-BE Shell Milling Cutters – Fine Pitch

INCH **MANANOVA** Easy Choice – Fast Delivery

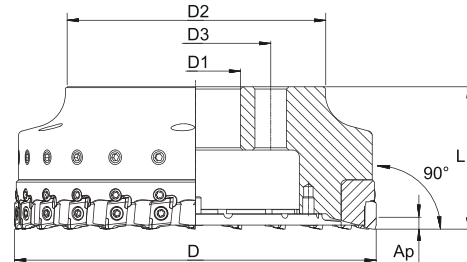

INCH

Inserts see page 21-23

Inventory	
Code	In stock, MANANOVA
○	Made to order

Specification	Inventory	D	D1	D2	D3	L	Ap max	Z	kg	max RPM	Material
FMP2.00SA0.75-BE12-08	040401060049	2.00	0.75	1.772	—	1.575	0.45	8	0.48	35100	Steel
FMP2.50SA0.75-BE12-10	040401060050	2.50	0.75	1.772	—	1.575	0.45	10	0.71	30200	Steel
FMP3.00SA1.00-BE12-12	040401060051	3.00	1.00	1.969	—	1.969	0.45	12	0.75	27500	Steel+Aluminium
FMP4.00SB1.25-BE12-16	040401060044	4.00	1.25	2.756	—	1.969	0.45	16	1.32	23800	Steel+Aluminium
FMP5.00SB1.50-BE12-20	040401060048	5.00	1.50	3.543	—	2.480	0.45	20	2.31	19100	Steel+Aluminium

Cutters delivered assembled with spare parts, but without inserts, dynamically balanced to G2.5 at 25000 RPM

unit: in

Spare Parts

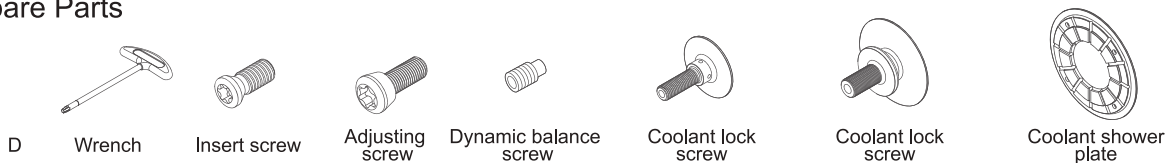

D	Wrench	Insert screw	Adjusting screw	Dynamic balance screw	Coolant lock screw	Coolant lock screw	Coolant shower plate
2.00	15IP	S40120J	S30110G	0204010265	FMP2.00SA0.75-BE12-08.02	—	—
2.50	15IP	S40120J	S30110G	0204010265	FMP2.50SA0.75-BE12-10.02	—	—
3.00	15IP	S40120J	S30110G	0204010265	FMP3.00SA1.00-BE12-12.03	—	—
4.00	15IP	S40120J	S30110G	B03400252	—	FMP4.00SB1.25-BE12-16.03	—
5.00	15IP	S40120J	S30110G	B03400252	—	FMP5.00SB1.50-BE12-20.03	—

FMP-BE Shell Milling Cutters – Light Weight/ Coarse Pitch

ISO **MANANOVA** Easy Choice – Fast Delivery

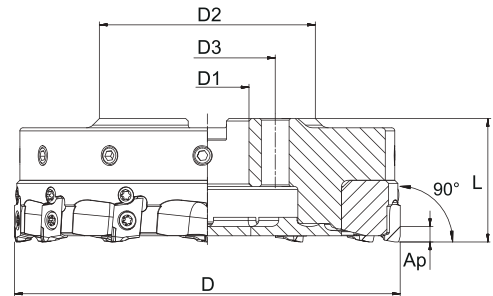

ISO

Inserts see page 21-23

Inventory	
Code	In stock. MANANOVA
○	Made to order

Specification	Inventory	D	D1	D2	D3	L	Ap max	Z	kg	max RPM	Material
FMP080SB27-BE12-08	040401060029	80	27	70	—	40	11	8	0.78	27500	Steel+Aluminium
FMP100SB27-BE12-08	040401060028	100	27	70	—	40	11	8	1.12	23800	Steel+Aluminium
FMP125SC27-BE12-12	040401060027	125	27	70	54	40	11	12	1.43	19100	Steel+Aluminium
FMP160SC27-BE12-12	040401060026	160	27	70	54	40	11	12	2.00	14900	Steel+Aluminium

Cutters delivered assembled with spare parts, but without inserts, dynamically balanced to G2.5 at 25000 RPM

unit: mm

Spare Parts

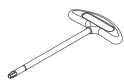

D

Wrench

Insert screw

Adjusting screw

Dynamic balance screw

Coolant lock screw

Coolant lock screw

Coolant shower plate

80	15IP	S40120J	S30110G	0204010265	—	FMP080SB27-BE12-08.03	—
100	15IP	S40120J	S30110G	0204010265	—	FMP100SB27-BE12-08.03	—
125	15IP	S40120J	S30110G	0204010265	—	—	FMP125SC27-BE12-12.03
160	15IP	S40120J	S30110G	B03400252	—	—	FMP160SC27-BE12-12.03

FMP-BE Shank and Screw-On Milling Cutters

ISO **MANANOVA** Easy Choice – Fast Delivery

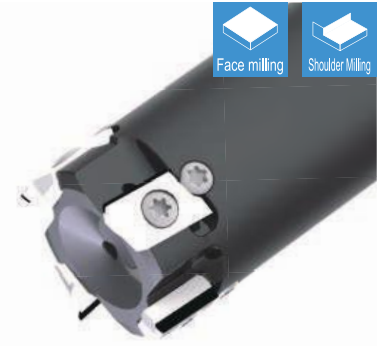
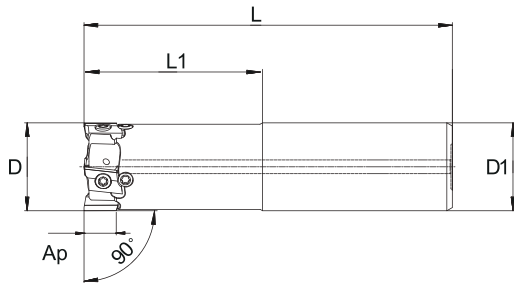

Inventory Code	Availability
○	In stock, MANANOVA
○	Made to order

ISO

Inserts see page 21-23

Specification	Inventory	D	D1	D2	L	L1	Ap max	Z	kg	max RPM	Material
FMP025CS25-BE12-03	040401070087	25	25	—	130	50	11	3	0.50	25000	Steel
FMP032CS32-BE12-04	040401070005	32	32	—	130	50	11	4	0.80	25000	Steel

unit: mm

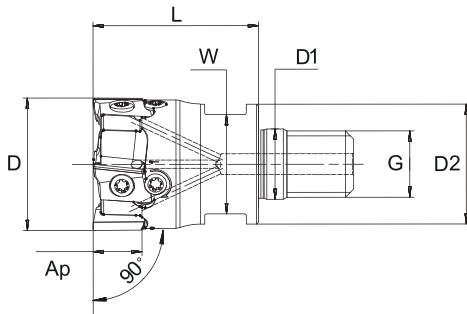

Inventory Code	Availability
○	In stock, MANANOVA
○	Made to order

ISO

Inserts see page 21-23

Specification	Inventory	D	D1	D2	L	L1	G	W	Ap max	Z	kg	max RPM	Material
FMP025M12-BE12-03	040401070088	25	12.5	21	40	—	M12	17	11	3	0.13	25000	Steel
FMP032M16-BE12-04	040401070089	32	17	29	40	—	M16	24	11	4	0.23	25000	Steel

unit: mm

Spare Parts

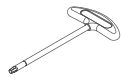

D

Wrench

Insert screw

Adjusting screw

25	15IP	S40090J	S30110G
32	15IP	S40090J	S30110G

FMP-BE Disc Milling Cutters ISO

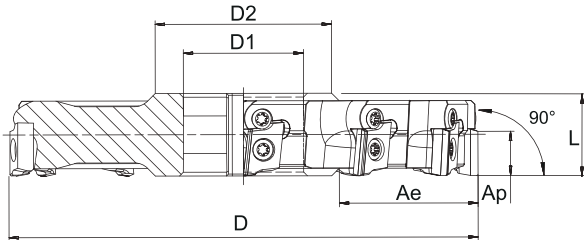

Inventory	
Code	In stock. MANANOVA
○	Made to order

ISO

Inserts see page 21-23

Specification	Inventory	D	D1	D2	L	Ap max	Ae max	Z _{eff}	Z _{axial}	kg	max RPM	Material
RH cutting												
SMP100CA32-BE12-10R	○	100	32	47	22	11	20	10	10	0.85	27000	Steel
SMP125CA32-BE12-12R	○	125	32	47	22	11	30	12	12	1.40	24000	Steel
SMP160CA40-BE12-14R	○	160	40	55	22	11	45	14	14	2.20	21300	Steel
SMP200CA40-BE12-16R	○	200	40	55	22	11	65	16	16	3.50	19100	Steel
LH cutting												
SMP100CA32-BE12-10L	○	100	32	47	22	11	20	10	10	0.85	27000	Steel
SMP125CA32-BE12-12L	○	125	32	47	22	11	30	12	12	1.40	24000	Steel
SMP160CA40-BE12-14L	○	160	40	55	22	11	45	14	14	2.20	21300	Steel
SMP200CA40-BE12-16L	○	200	40	55	22	11	65	16	16	3.50	19100	Steel

unit: mm

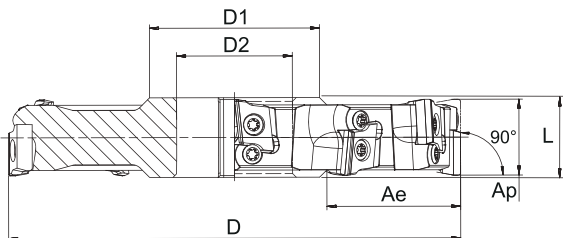

ISO

Inserts see page 21-23

Inventory	
Code	In stock. MANANOVA
○	Made to order

Specification	Inventory	D	D1	D2	L	Ap max	Ae max	Z _{eff}	Z _{axial}	kg	max RPM	Material
SMP100CA32-BE12-10N	○	100	32	47	22	21	20	5+5	5+5	0.85	27000	Steel
SMP125CA32-BE12-12N	○	125	32	47	22	21	30	6+6	6+6	1.40	24000	Steel
SMP160CA40-BE12-14N	○	160	40	55	22	21	45	7+7	7+7	2.20	21300	Steel
SMP200CA40-BE12-16N	○	200	40	55	22	21	65	8+8	8+8	3.50	19100	Steel

unit: mm

Customized FMP-BE Cutters

Designed for

- Complex structures and special tool diameter, length and rigidity requirements
- Flexible machining of cavities, shoulders etc.

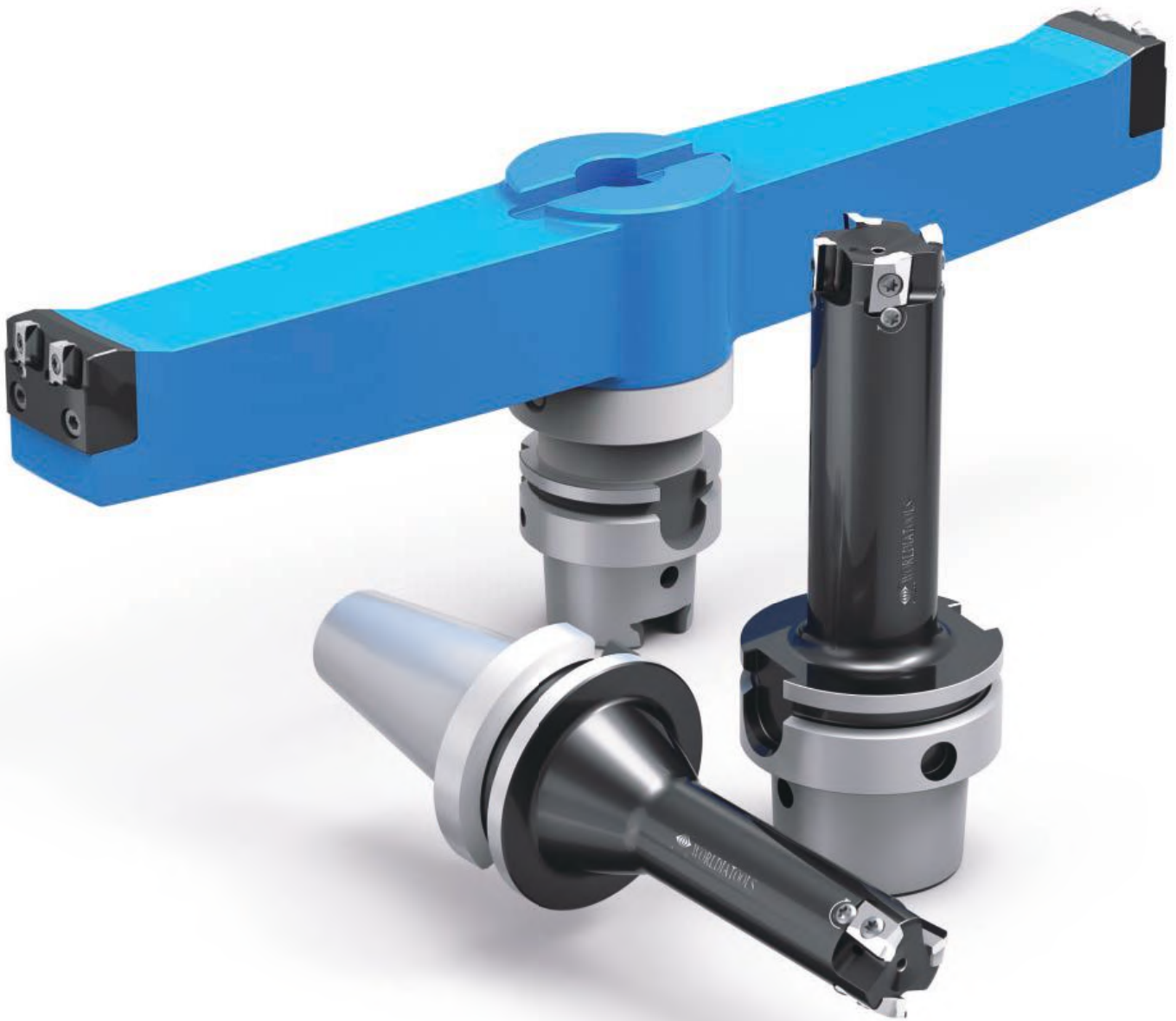

Worldia FMP-SD Indexable Milling Cutters

High-speed cutting with PCBN

Main Applications

High-speed semi-finish and finish face milling of cast iron and hardened materials with high requirements to surface finish and waviness.

Design Features

- Cutter body is made of hardened Steel-Alloy, machined by 5-axis hard milling
- High-precision insert pocket seats keeping 0,01 mm axial runout without insert adjustment
- As a standard, each pocket can also be adjusted to 2 μm axial runout within a 0,3 mm range
- Positive rake angles for smooth cutting and chip removal from surface
- Separation between insert positioning face and cutting edge to protect cutting edge and to simplify the use of relapped inserts
- Insert wedge clamping system allows easy exchange of inserts and reliable clamping
- SDHN inserts are available in a variety of wiper and corner designs for many different applications in semi-finish and finish face milling
- Full-face PCBN inserts with 4 cutting edges and regrinding option for low cutting tool cost
- Internal coolant through cutter body



Worldia FMP-SD Indexable Milling Cutters

High-speed cutting with PCBN

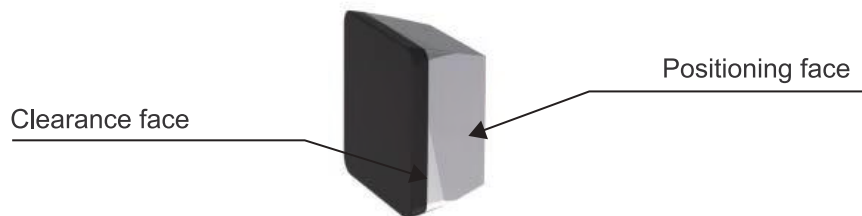
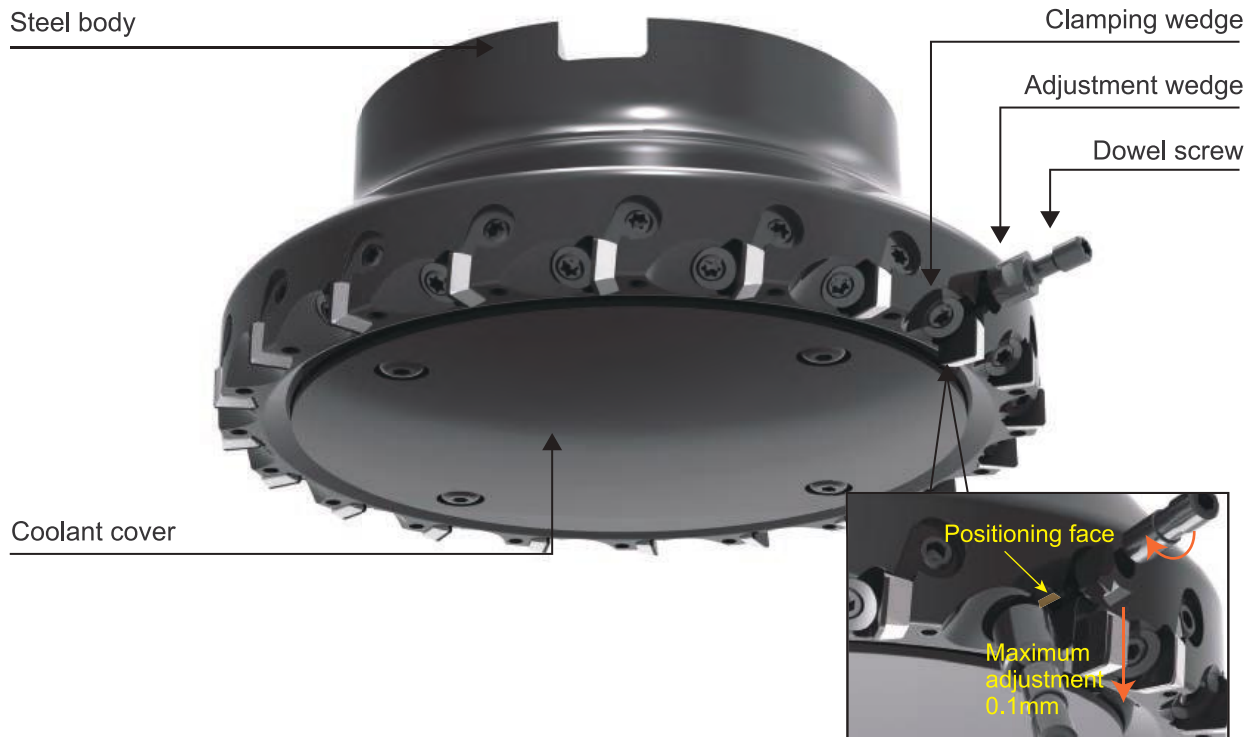

FMP-SD Shell Milling Cutters Specifications

MANANOVA Easy Choice – Fast Delivery

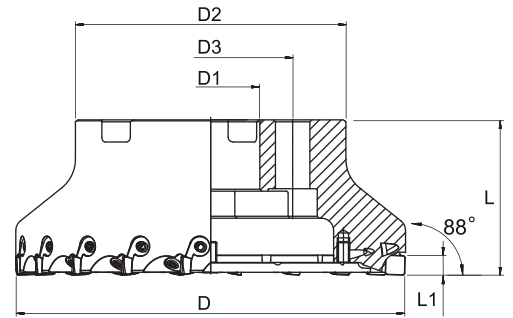

Ap max = 0,5 mm

ISO

Inserts see page 24

Inventory	
Code	In stock. MANANOVA
○	Made to order

Specifications	Inventory	D	D1	D2	D3	L	L1	Z	kg	max RPM
FMP050SA22-SD07-05	040401060023	50	22	45	—	40	7.94	5	0.40	9500
FMP063SA22-SD07-08	040401060022	63	22	45	—	40	7.94	8	0.60	7500
FMP080SA27-SD07-10	040401060021	80	27	60	—	50	7.94	10	1.20	6000
FMP100SB32-SD07-12	040401060020	100	32	80	—	50	7.94	12	1.90	4700
FMP125SB40-SD07-16	040401060019	125	40	90	—	63	7.94	16	3.20	3800
FMP160SC40-SD07-20	040401060018	160	40	110	66.7	63	7.94	20	4.50	3000
FMP200SC60-SD07-24	040401060017	200	60	150	101.6	63	7.94	24	6.80	2300
FMP250SC60-SD07-32	040401060016	250	60	200	101.6	63	7.94	32	11.6	1900

unit: mm

Spare Parts



D Wrench



Dowel screw



Wedge block



Adjustment block



Coolant lock screw(1)



Coolant lock screw(2)



Coolant shower plate

50	15IP	M5*20	FMPSD07.01	FMPSD07.02	FMP050SA22-SD07-05.02	—	—
63	15IP	M5*20	FMPSD07.01	FMPSD07.02	FMP063SA22-SD07-08.02	—	—
80	15IP	M5*20	FMPSD07.01	FMPSD07.02	FMP080SA27-SD07-10.02	—	—
100	15IP	M5*20	FMPSD07.01	FMPSD07.02	—	FMP100SB32-SD07-12.02	—
125	15IP	M5*20	FMPSD07.01	FMPSD07.02	—	FMP125SB40-SD07-16.02	—
160	15IP	M5*20	FMPSD07.01	FMPSD07.02	—	—	FMP160SC40-SD07-20.02
200	15IP	M5*20	FMPSD07.01	FMPSD07.02	—	—	FMP200SC60-SD07-24.02
250	15IP	M5*20	FMPSD07.01	FMPSD07.02	—	—	FMP250SC60-SD07-30.02

Customized FMP-SD Cutters

Designed for special applications including disc milling,
rear face of machine guideways etc.

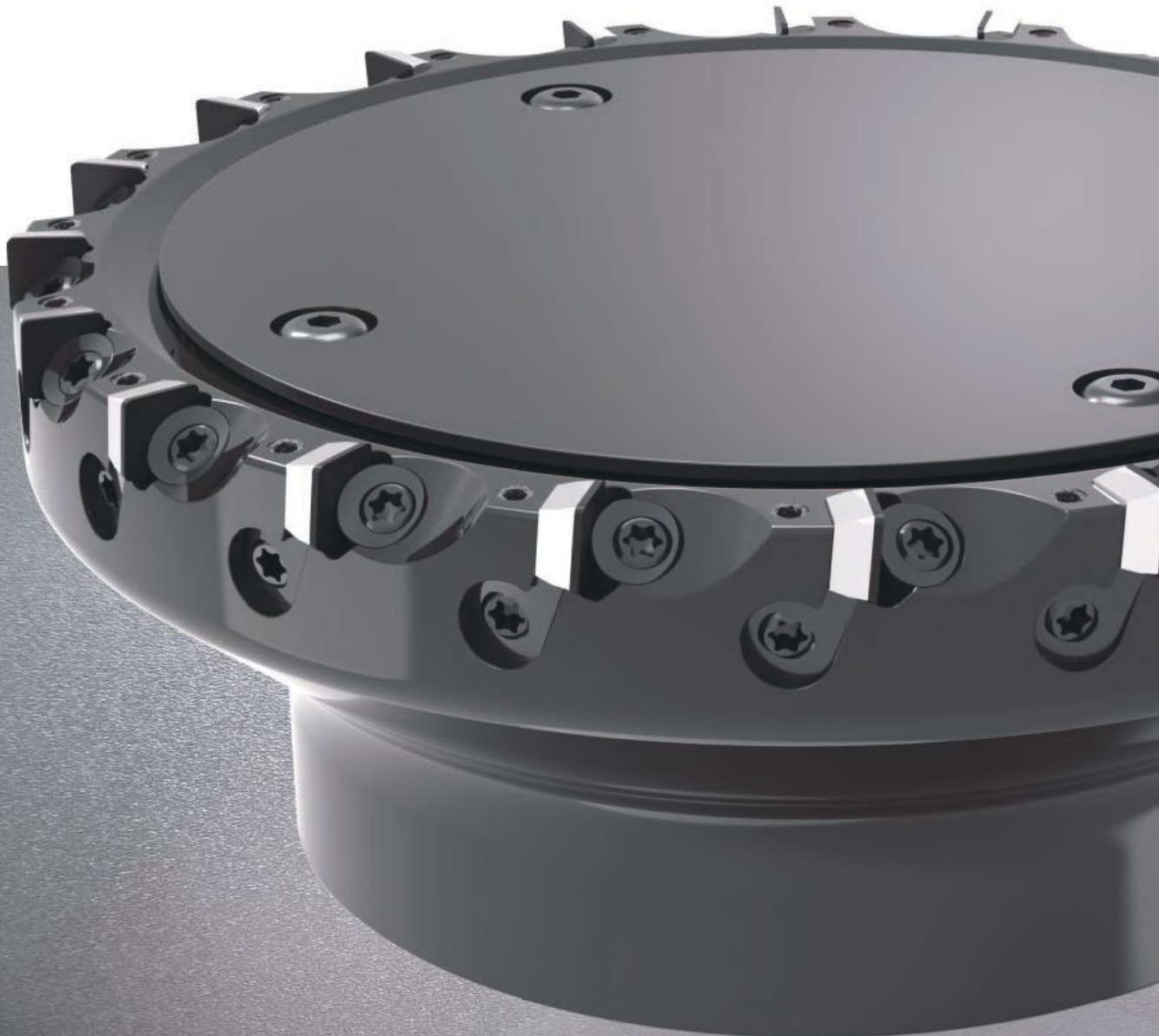

Milling Adaptors BT / HSK

BT

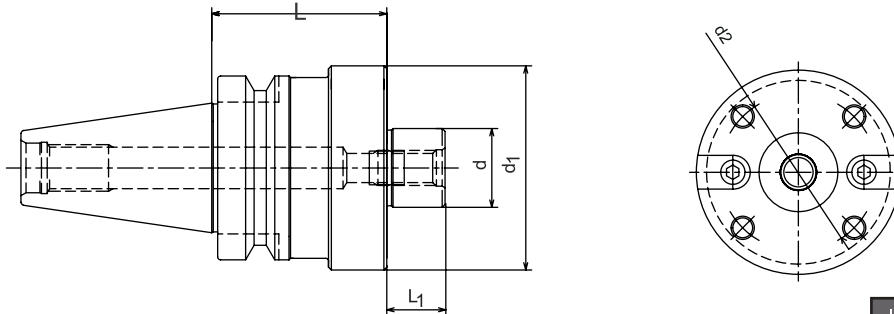

Inventory	
Code	Upon request

Specifications	Inventory	d	d1	d2	L1	L	kg
BT30-FMB16C-45	SC43129	16	34	—	18	45	0.70
BT30-FMB22C-45	SC40042	22	48	—	18	45	0.74
BT30-FMB27C-45	SC38061	27	60	—	20	45	1.10
BT40-FMB22C-45	SC38884	22	48	—	18	45	1.30
BT40-FMB27C-45	SC88885	27	60	—	20	45	1.50
BT40-FMB32C-50	SC39342	32	78	—	22	50	2.00
BT40-FMB40FC-60	SC43136	40	89	66.7	25	60	2.80
BT50-FMB40FC-75	SC43137	40	89	66.7	25	75	5.80
BT50-FMB60FC-75	SC40576	60	129	101.6	32	75	8.30

unit: mm

HSK

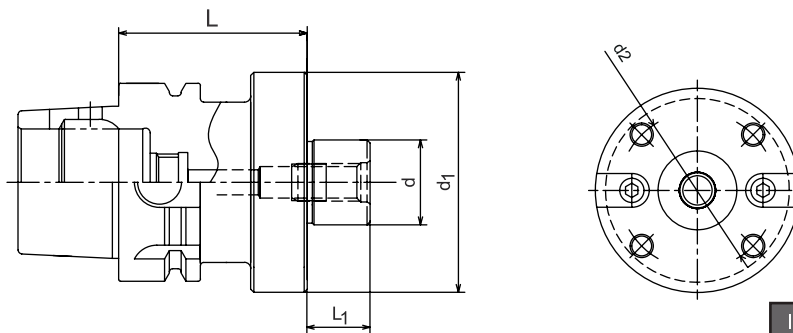

Inventory	
Code	Upon request

Specifications	Inventory	d	d1	d2	L1	L	kg
HSK63A-FMB16C-100	SC43126	16	35	—	16	100	1.80
HSK63A-FMB22C-50	SC39338	22	48	—	18	50	1.00
HSK63A-FMB27C-60	SC39339	27	60	—	20	60	1.50
HSK63A-FMB32C-60	SC39340	32	78	—	22	60	1.90
HSK63A-FMB40FC-60	SC39180	40	89	66.7	25	60	2.50
HSK100A-FMB40FC-75	SC43127	40	89	66.7	25	75	4.60
HSK100A-FMB60FC-70	SC43128	60	129	101.6	32	70	6.30

unit: mm

Light Weight Milling Adaptors BT / HSK

BT

JIS B
6339

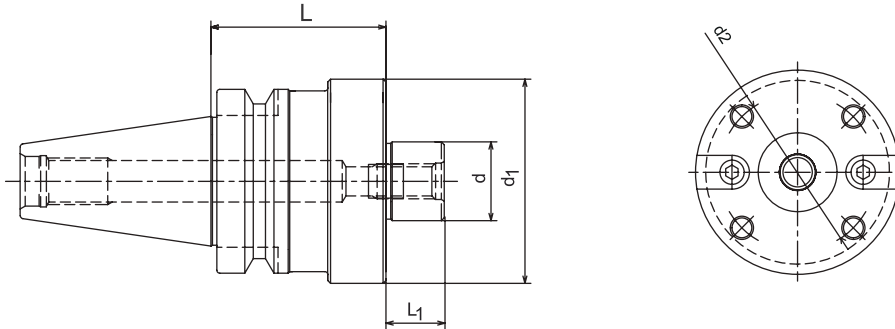

Inventory	
Code	Upon request

Specifications	Inventory	d	d1	d2	L1	L	Kg
BT30-FMB27FC-45	SC39069	27	70	54	20	45	1.20
BT40-FMB27FC-60	SC39799	27	70	54	20	60	2.50

unit: mm

HSK

DIN
69893

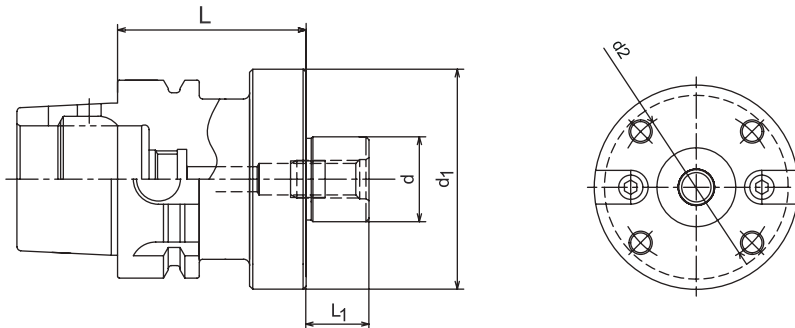

Inventory	
Code	Upon request

Specifications	Inventory	d	d1	d2	L1	L	Kg
HSK63A-FMB27FC-60	SC39798	27	70	54	20	60	1.60

unit: mm

Insert Nomenclature

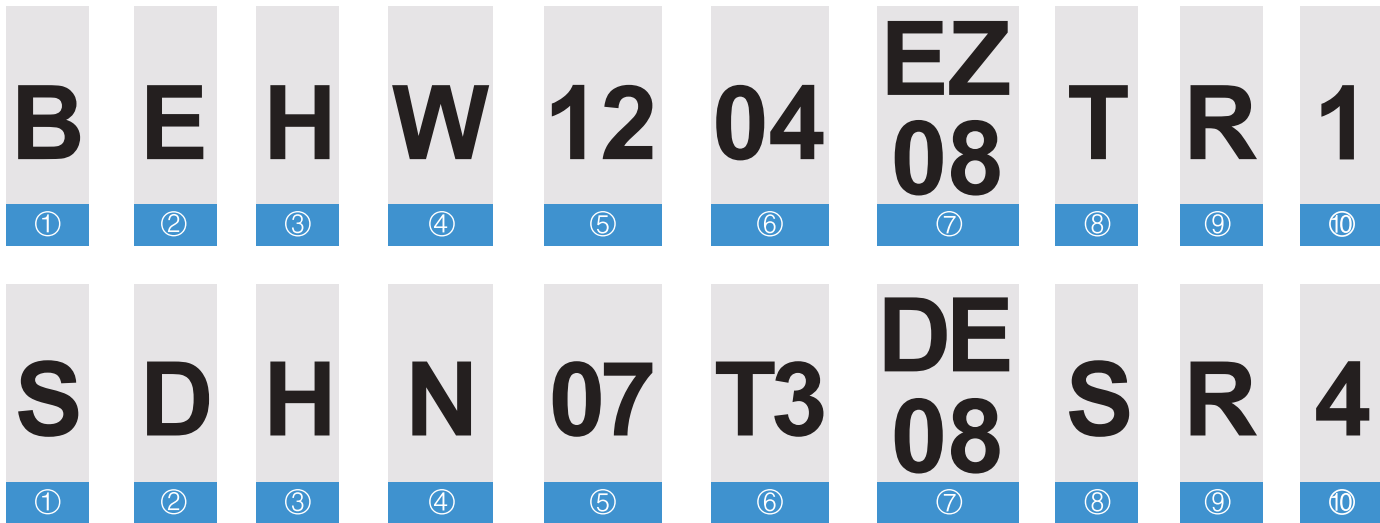

① Shape		
Code	Shape	
O	Octagonal	
S	Square	
T	Triangle	
C	Diamond 80°	
L	Rectangular 90°	
B	Diamond 82°	
R	Round	
X	Special	—

② Clearance angle	
Code	Clearance Angle
C	7°
D	15°
E	20°
F	25°
G	30°
N	0°
P	11°
Z	Other clearance angle

③ Tolerance			
Code	Nose Height m (mm)	Inscribed Circle Diameter ϕD_1 (mm)	Tolerance S1 (mm)
A	± 0.005	± 0.025	± 0.025
C	± 0.013	± 0.025	± 0.025
E	± 0.025	± 0.025	± 0.025
H	± 0.013	± 0.013	± 0.025
K*	± 0.013	$\pm 0.05 - \pm 0.15$	± 0.025
M*	$\pm 0.08 - \pm 0.18$	$\pm 0.05 - \pm 0.15$	± 0.13
N*	$\pm 0.08 - \pm 0.18$	$\pm 0.05 - \pm 0.15$	± 0.025

*standard for no lapping on the side face.

④ Chip breaker and Fixing type				
Code	Bore	Shape of Bore	Chip Breaker	Shape
W	With Bore	Cylindrical Bore + Single Side (40° – 60°)	Without	
T	With Bore		Single	
B	With Bore	Cylindrical Bore + Single Side (70° – 90°)	Without	
N	Without		Without	
R	Without	—	Single	
X	—	—	—	Special

⑤ Inscribed circle Dia.				
Code				Inscribed Circle (mm)
06	06	06		6,35
08	07	07		7,94
09	09	09		9,525
				10,00
				12,00
12	12	12		12,70
16	15	15		15,875
				20,00

Insert Nomenclature

-WG

⑪

-R04CB05

⑫

-WG



⑪

⑥ Thickness	
	
Code	Thickness (mm)
T3	3.97
04	4.76
05	5.56
06	6.35



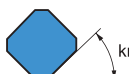

⑨ Cutting direction	
Code	Cutting Direction
L	Left Hand
N	Left & Right
R	Right Hand

⑩ Edges	
Code	Edges
1	1 edge
2	2 edge
4	4 edge

⑪ Cutting edge design	
WG	Wiper
UW	Universal
PT	Corner

⑦ Tip radius			
			
Code	Mark (mm)	Code	Mark (mm)
00	0.0	08	0.8
02	0.2	12	1.2
04	0.4	16	1.6
Tool cutting edge angle		Clearance angle of wiper	
			
Code	Mark	Code	Mark
A	45°	P	11°
D	60°	D	15°
E	75°	E	20°
P	90°	F	25°
Z	Other	Z	Other

⑫ Corner Radius / Chamfer				Tip Length CB	
Code	Shape	Code	Mark (mm)	Code	Mark (mm)
R	Radius	03	0.3	05	5
C	Chamfer	04	0.4	08	8
		08	0.8	12	12

⑧ Cutting edge design	
Code	Cutting Edge Design
E	 Honed
F	 Sharp Edge
T	 Chamfered
S	 Chamfered + Honed
Z	 Chamfered

BEHW PCD-tipped Milling Inserts for Light and Medium Applications

PCD-tipped milling inserts with various angles, wipers and corner radii for face and shoulder milling applications with higher depth of cut and Si-content ≤10%.
Please see page 27-29 for application recommendations.

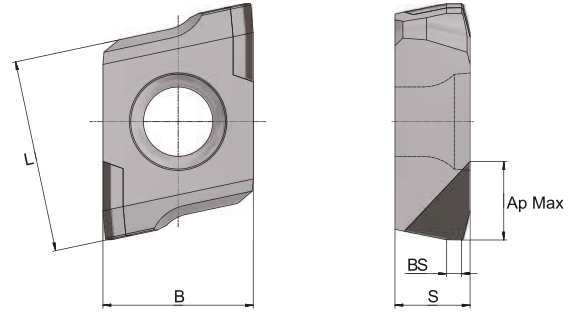

Dimensions		
L (mm)	B (mm)	S (mm)
12.2	9.525	4.76

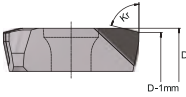
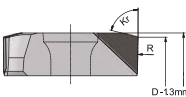
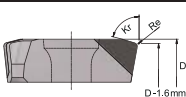
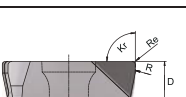
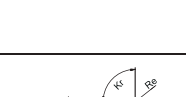
Figure	Cutter diameter		Specification	Cutting Edge	Dimensions					N
	25 - 40 mm	>40 mm			Cutting Tips	BS (mm)	Ap Max (mm)	Kr (°)	Re (mm)	
Standard 75° 		✓	BEHW1204EZFR1 C03CB05	F	1	1	4	75	—	HS03050
	✓		BEHW1204EZFR1B C03CB05	F	1	1	4	75	—	HS03615
		✓	BEHW1204EZFR2 C03CB05	F	2	1	4	75	—	HS03665
Wiper 75° 		✓	BEHW1204EZFR1-WG C03CB05	F	1	4	4	75	—	HC03020
	✓		BEHW1204EZFR1B-WG C03CB05	F	1	4	4	75	—	HC07955
		✓	BEHW1204EZFR2-WG C03CB05	F	2	4	4	75	—	HS05456
Corner 75° 		✓	BEHW1204EZFR1-PT R04CB05	F	1	-	4	75	0.4	HS01342
	✓		BEHW1204EZFR1B-PT R04CB05	F	1	-	4	75	0.4	HC03861
		✓	BEHW1204EZFR2-PT R04CB05	F	2	-	4	75	0.4	HC01106
Universal 90° 		✓	BEHW1204PZFR1-JW R04CB05	F	1	1.5	4	90	0.4	HC02033
		✓	BEHW1204PZFL1-JW R04CB05	F	1	1.5	4	90	0.4	○
	✓		BEHW1204PZFR1B-JW R04CB05	F	1	1.5	4	90	0.4	HS03185
		✓	BEHW1204PZFR2-JW R04CB05	F	2	1.5	4	90	0.4	HS03630
Full Length 90° 		✓	BEHW1204PZFR1 R04CB12	F	1	1.5	11	90	0.4	HS01810
		✓	BEHW1204PZFL1 R04CB12	F	1	1.5	11	90	0.4	○
	✓		BEHW1204PZFR1B R04CB12	F	1	1.5	11	90	0.4	HC03161

Inventory	Delivery Time	
C Code	In stock, MANANOVA	max.1 week
○	Semi-standard, made to order	approx.5 weeks
C	Customized, made to order	approx.8 weeks

BEHW PCD-tipped Milling Inserts for Heavy Duty Applications

PCD-tipped milling inserts with various angles, wipers and corner radii for face and shoulder milling applications with higher depth of cut and Si-content $\geq 10\%$. Please see page 27-29 for application recommendations.

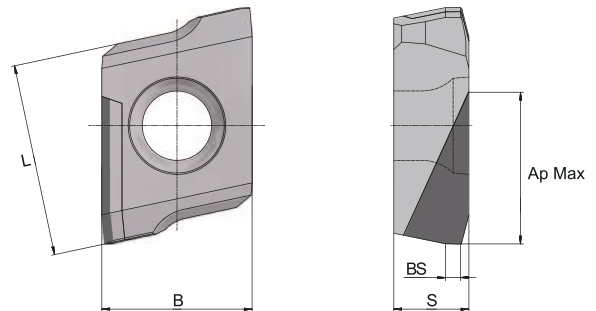

Dimensions		
L (mm)	B (mm)	S (mm)
12.2	9.525	4.76

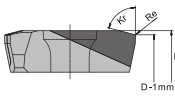
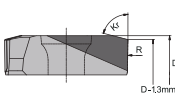
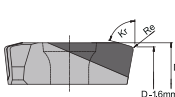
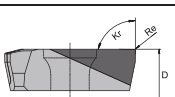
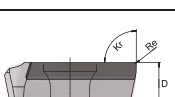
Figure	Cutter diameter		Specification	Cutting Edge	Dimensions					N	
	25 - 40 mm	>40 mm			Cutting Tips	BS (mm)	Ap Max (mm)	Kr (°)	Re (mm)	PD10E	PD32E
Standard 75° 		✓	BEHW1204EZTR1 R04CB08	T1	1	1	7	75	0,4	HC01763	○
	✓		BEHW1204EZTR1B R04CB08	T1	1	1	7	75	0,4	HC02636	○
Wiper 75° 		✓	BEHW1204EZTR1-WG C03CB08	T1	1	4	7	75	—	HC03136	○
	✓		BEHW1204EZTR1B-WG C03CB08	T1	1	4	7	75	—	HS05491	○
Corner 75° 		✓	BEHW1204EZTR1-PT R04CB08	T1	1	-	7	75	0,4	HC02508	○
	✓		BEHW1204EZTR1B-PT R04CB08	T1	1	-	7	75	0,4	HC14492	○
Universal 90° 		✓	BEHW1204PZTR1 R04CB08	T1	1	1	7	90	0,4	HC04256	○
		✓	BEHW1204PZTL1 R04CB08	T1	1	1	7	90	0,4	○	○
	✓		BEHW1204PZTR1B R04CB08	T1	1	1	7	90	0,4	HC04156	○
Full Length 90° 		✓	BEHW1204PZTR1 R08CB12	T1	1	1	11	90	0,8	HC02296	○
		✓	BEHW1204PZTL1 R08CB12	T1	1	1	11	90	0,8	○	○
	✓		BEHW1204PZTR1B R08CB12	T1	1	1	11	90	0,8	HC14044	○

Inventory	Delivery Time	
Code	In stock, MANANOVA	max.1 week
○	Semi-standard, made to order	approx.5 weeks
C	Customized, made to order	approx.8 weeks

BEHW PCBN-tipped Milling Inserts for Face and Shoulder Milling Applications

PCBN-tipped milling inserts with various angles, wipers and corner radii for face and shoulder milling applications of cast iron and hardened materials with higher depth of cut. Please see page 30 for application recommendations.

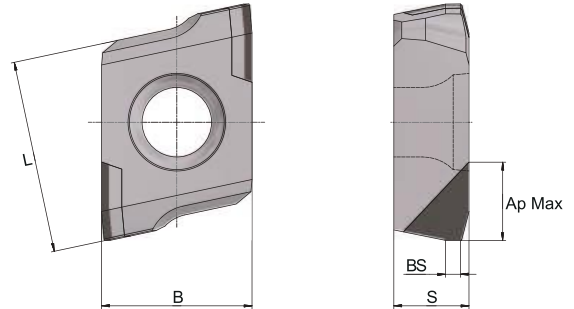

Dimensions		
L (mm)	B (mm)	S (mm)
12.2	9.525	4.76

Figure	Cutter diameter		Specification	Cutting Edge	Dimensions					K	H
	25 - 40 mm	>40 mm			Cutting Tips	BS (mm)	Ap Max (mm)	Kr (°)	Re (mm)	PNK3003	PNH2019
 Wiper 75°		✓	BEHW1204EZSR1-WG C03CB05	S8	1	4	0.5	75	—	○	○
	✓		BEHW1204EZSR1B-WG C03CB05	S8	1	4	0.5	75	—	○	○
		✓	BEHW1204EZSR2-WG C03CB05	S8	2	4	0.5	75	—	○	○
 Standard 90°		✓	BEHW1204PZSR1 R04CB05	S11	1	1.5	0.5	90	0.4	○	○
	✓		BEHW1204PZSR1B R04CB05	S11	1	1.5	0.5	90	0.4	○	○
		✓	BEHW1204PZSR2 R04CB05	S11	2	1.5	0.5	90	0.4	○	○
 Standard 90°		✓	BEHW1204PZSR1 R08CB05	S11	1	1.5	0.5	90	0.8	○	○
	✓		BEHW1204PZSR1B R08CB05	S11	1	1.5	0.5	90	0.8	○	○
		✓	BEHW1204PZSR2 R08CB05	S11	2	1.5	0.5	90	0.8	○	○

Inventory	Delivery Time	
Code	In stock, MANANOVA	max.1 week
○	Semi-standard, made to order	approx.5 weeks
C	Customized, made to order	approx.8 weeks

SDHN Full-Face PCBN Milling Inserts for Finish Face Milling Applications

PCBN full-face milling inserts with various angles and wipers for finish face milling of cast iron and hardened materials.

Please see page 30 for application recommendations.

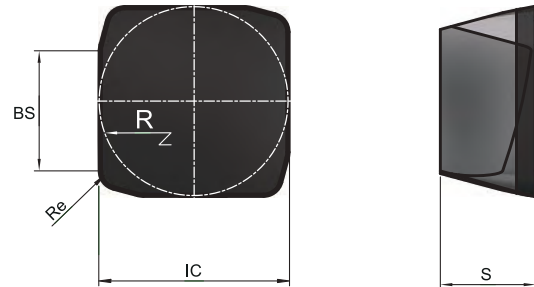

Dimensions	
IC (mm)	S (mm)
7.94	3.97

Figure	Specification	Cutting Edge	Dimensions				K
			Cutting Edges	BS (mm)	Ap Max (mm)	Re (mm)	
Corner Radius	SDHN07T308	S12	4	-	0.5	0.8	PNK3003
Standard	SDHN07T3PPSR4	S12	4	1.5	0.5	0.8	HS09896
Universal	SDHN07T3PPSR4-UW	S12	4	1.5	0.5	0.8	HS09897
Wiper	SDHN07T3DPSR4-WG	S8	4	5	0.5	0.8	HS10976

Inventory	Delivery Time	
Code	In stock, MANANOVA	max.1 week
○	Semi-standard, made to order	approx.5 weeks
C	Customized, made to order	approx.8 weeks

PCD Grades and Application Recommendations

WORLDIA® PCD Grades

Worldia's portfolio comprises of a variety of different PCD and CVD materials that will be selected based on your specific application requirements. Below grades are a selection that covers the most common applications.

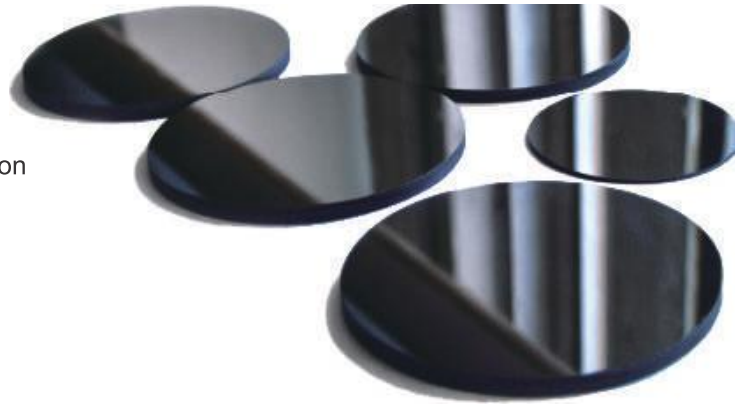

Application Recommendations

Grades

Workpiece Material	Grade	Grain size (µm)	Characteristics	Application
N	PD10E	10	PD10E is the universal grade in the market. It's the first choice for many applications where a good balance of toughness and wear resistance are required.	This grade is commonly used for non-ferrous finishing applications. Other successful applications include machining of wood, MDF, low-medium content silicon aluminium alloys, carbide, hard rubber, graphite and so on.
	PD32E	2~30	PD32E has a unique combination of wear resistance, edge strength and edge quality. It contains a carefully selected mix of micron diamond (between 2 - 30 µm). The combination of these particle sizes and a specifically developed high pressure sintering process produces a structure with extreme abrasion resistance and good thermal stability.	Application areas include the machining of abrasive workpieces such as MMC, high silicon aluminium alloys as well as machining of carbide, hard rubber, graphite and other materials.

Cutting Edge

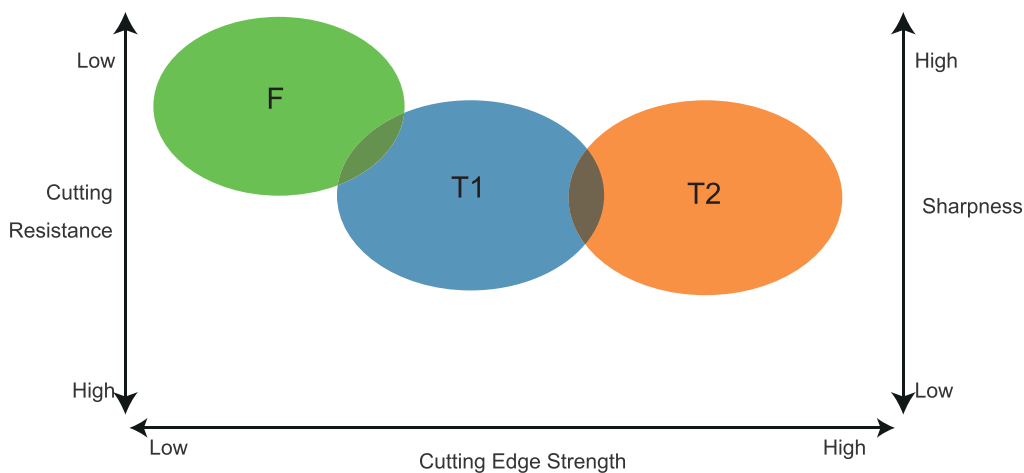

PCBN Grades and Application Recommendations

WORLDIA® PCBN Grades

PCBN is considerably better abrasive resistant than tungsten carbide and ceramics. PCBN will not have any chemical reaction with ferrous material at 1200-1300 °C .

So PCBN material is unique for dry cutting ferrous material.

The principal application areas for PCBN cutting tools are hardened steels, cast irons and sintered irons as well as powder metallurgy components.

Below grades are our recommendations for most milling applications. However, based on analysis of your specific requirements, we will suggest the most appropriate grade for your application from our comprehensive portfolio.



Application Recommendations

Grades

Workpiece Material	Grade	Content %	Grain Size (µm)	Hardness	Characteristic	Application
K	PNK3003	90~95	1~3	3700~3900	Combination of wear resistance and impact resistance	Cast iron, sintered iron
H	PNH2019	65~70	1	2700~2900	Combination of wear resistance and impact resistance	Hardened steel

Cutting Data Recommendations



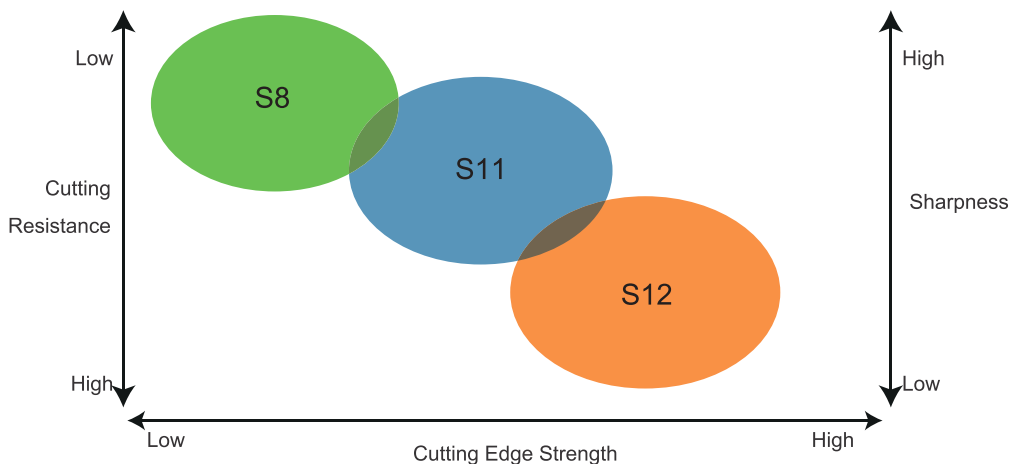

PCBN Grade	Cutting Data Recommendations		
	Cutting Speed,vc (m/min)	Feed Rate,fn (mm/r)	Cutting Depth,AP (mm)
PNK3003	300 600 800 1200	0.03 0.08 0.12 0.3	0.05 0.5
PNH2019	100 150 220 250	0.03 0.08 0.1 0.12	0.05 0.3

Cutting Edge



Application Case Studies and Worldia Recommendations

New Energy Vehicle Components

Figure	Processing conditions	Processing parameters		
	Workpiece: Motor end cover Material: Aluminum alloy Spindle: Single spindle Maximum speed: 16000RPM Adaptor: BT40 Surface finish: Ra1.25		Previous	Worldia
		Cutter	—	FMP100SB32-BE12-16
		Insert	—	BEHW1204PZFR1-UW 12 pcs BEHW1204EZFR1-WG 4 pcs
		Grade	—	PD10E
		Cutter diameter (mm)	φ100	φ100
		Number of teeth	6	16
		Cutting length (mm)	580	580
		Cutting speed (m/min)	2200	3140
		Feed per tooth (mm/z)	0.1	0.063
		Depth of cut (mm)	4.2	4.2
		Milling time roughing (s)	7.73	0
		Milling time finishing (s)	8.70	3.48
		Total (s)	16.43	3.48
Productivity	—	4.7 X		
	Workpiece: Gearbox housing for commercial vehicles Material: Aluminum alloy Spindle: Single spindle Maximum speed: 16000RPM Adaptor: BT50 Surface finish: Ra1.25		Previous	Worldia
		Cutter	Integral PCD Milling Cutter	FMP080SA27-BE12-12
		Insert	—	BEHW1204PZFR1-UW 10 pcs BEHW1204EZFR1-WG 2 pcs
		Grade	—	PD10E
		Cutter diameter (mm)	φ80	φ80
		Number of teeth	8	12
		Cutting length (mm)	960	960
		Cutting speed (m/min)	2010	3016
		Feed per tooth (mm/z)	0.1	0.07
		Depth of cut (mm)	4.5	4.5
		Milling time roughing (s)	7.63	0
		Milling time finishing (s)	9.60	5.76
		Total (s)	17.23	5.76
Productivity	—	3 X		
	Workpiece: Integrate valve of heat pump Material: Aluminum alloy Spindle: Single spindle Maximum speed: 16000RPM Adaptor: BT40 Surface finish: Ra0.8		Previous	Worldia
		Cutter	—	FMP125SB40-BE12-20
		Insert	—	BEHW1204PZFR1-UW 16 pcs BEHW1204EZFR1-WG 4 pcs
		Grade	—	PD10E
		Cutter diameter (mm)	φ60	φ125
		Number of teeth	6	20
		Cutting length (mm)	440	220
		Cutting speed (m/min)	1320	3927
		Feed per tooth (mm/z)	0.1	0.04
		Depth of cut (mm)	Ap1 = 2 AP2 = 0.2	2.2
		Milling time roughing (s)	6.60	0
		Milling time finishing (s)	6.60	1.65
		Total (s)	13.20	1.65
Productivity	—	8 X		
	Workpiece: Battery compartment Material: Aluminum alloy Spindle: Single spindle Maximum speed: 16000RPM Adaptor: HSK63A Surface finish: Ra2.5		Previous	Worldia
		Cutter	—	FMP080SA27-BE12-12
		Insert	—	BEHW1204PZFR1-UW 10 pcs BEHW1204EZFR1-WG 2 pcs
		Grade	—	PD10E
		Cutter diameter (mm)	φ80	φ80
		Number of teeth	8	12
		Cutting length (mm)	960	960
		Cutting speed (m/min)	2011	3016
		Feed per tooth (mm/z)	0.1	0.07
		Depth of cut (mm)	4.5	4.5
		Milling time roughing (s)	7.63	0
		Milling time finishing (s)	9.60	5.76
		Total (s)	17.23	5.76
Productivity	—	3 X		

Application Case Studies and Worldia Recommendations

New Energy Vehicle Components

Figure	Processing conditions	Processing parameters																																										
	<p>Workpiece: ESC Material: ADC12 Spindle: Single spindle Maximum speed: 12000RPM Adaptors: BT40 Surface finish: Ra0.8</p>	<table border="1"> <thead> <tr> <th></th> <th>Previous</th> <th>Worldia</th> </tr> </thead> <tbody> <tr> <td>Cutter</td> <td>—</td> <td>FMP100SB32-BE12-16</td> </tr> <tr> <td>Insert</td> <td>—</td> <td>BEHW1204PZFR1-UW 12 pcs BEHW1204EZFR1-WG 4 pcs</td> </tr> <tr> <td>Grade</td> <td>PCD</td> <td>PD10E</td> </tr> <tr> <td>Cutter diameter (mm)</td> <td>φ100</td> <td>φ100</td> </tr> <tr> <td>Number of teeth</td> <td>6</td> <td>16</td> </tr> <tr> <td>Cutting length (mm)</td> <td>580</td> <td>580</td> </tr> <tr> <td>Cutting speed (m/min)</td> <td>2042 (rough) 2199 (finish)</td> <td>3142</td> </tr> <tr> <td>Feed per tooth (mm/z)</td> <td>0.12 (rough) 0.10 (finish)</td> <td>0.063</td> </tr> <tr> <td>Depth of cut (mm)</td> <td>AP1=4 AP2=0.2</td> <td>4.2</td> </tr> <tr> <td>Milling time roughing (s)</td> <td>7.73</td> <td>0</td> </tr> <tr> <td>Milling time finishing (s)</td> <td>8.70</td> <td>3.48</td> </tr> <tr> <td>Total (s)</td> <td>16.43</td> <td>3.48</td> </tr> <tr> <td>Productivity</td> <td>—</td> <td>4.7 X</td> </tr> </tbody> </table>		Previous	Worldia	Cutter	—	FMP100SB32-BE12-16	Insert	—	BEHW1204PZFR1-UW 12 pcs BEHW1204EZFR1-WG 4 pcs	Grade	PCD	PD10E	Cutter diameter (mm)	φ100	φ100	Number of teeth	6	16	Cutting length (mm)	580	580	Cutting speed (m/min)	2042 (rough) 2199 (finish)	3142	Feed per tooth (mm/z)	0.12 (rough) 0.10 (finish)	0.063	Depth of cut (mm)	AP1=4 AP2=0.2	4.2	Milling time roughing (s)	7.73	0	Milling time finishing (s)	8.70	3.48	Total (s)	16.43	3.48	Productivity	—	4.7 X
			Previous	Worldia																																								
Cutter	—	FMP100SB32-BE12-16																																										
Insert	—	BEHW1204PZFR1-UW 12 pcs BEHW1204EZFR1-WG 4 pcs																																										
Grade	PCD	PD10E																																										
Cutter diameter (mm)	φ100	φ100																																										
Number of teeth	6	16																																										
Cutting length (mm)	580	580																																										
Cutting speed (m/min)	2042 (rough) 2199 (finish)	3142																																										
Feed per tooth (mm/z)	0.12 (rough) 0.10 (finish)	0.063																																										
Depth of cut (mm)	AP1=4 AP2=0.2	4.2																																										
Milling time roughing (s)	7.73	0																																										
Milling time finishing (s)	8.70	3.48																																										
Total (s)	16.43	3.48																																										
Productivity	—	4.7 X																																										

Combustion Engine Components



Figure	Processing conditions	Processing parameters																														
	<p>Workpiece: Cylinder head Material: ALSi10MgCu Spindle: Single spindle Maximum speed: 12000RPM Adaptor: HSK63 Processing type: Surface milling Processing time: 1 Surface finish: Ra3.2</p>	<table border="1"> <thead> <tr> <th></th> <th>Previous</th> <th>Worldia</th> </tr> </thead> <tbody> <tr> <td>Cutter</td> <td>100B08RP90BG15C2WPM</td> <td>FMP100SB32-BE12-16</td> </tr> <tr> <td>Cutter diameter (mm)</td> <td>φ100</td> <td>φ100</td> </tr> <tr> <td>Number of teeth</td> <td>10</td> <td>16</td> </tr> <tr> <td>Inserts</td> <td>BGHXI 5L1 5PCTRHET</td> <td>BEHW1204EZFR1</td> </tr> <tr> <td>Grade</td> <td>PCD</td> <td>PD10E</td> </tr> <tr> <td>Cutting speed (m/min)</td> <td>2513</td> <td>2513</td> </tr> <tr> <td>Feed per tooth (mm/z)</td> <td>0.088</td> <td>0.055</td> </tr> <tr> <td>Depth of cut (mm)</td> <td>4</td> <td>4</td> </tr> <tr> <td>Tool life</td> <td></td> <td>1.6 X</td> </tr> </tbody> </table>		Previous	Worldia	Cutter	100B08RP90BG15C2WPM	FMP100SB32-BE12-16	Cutter diameter (mm)	φ100	φ100	Number of teeth	10	16	Inserts	BGHXI 5L1 5PCTRHET	BEHW1204EZFR1	Grade	PCD	PD10E	Cutting speed (m/min)	2513	2513	Feed per tooth (mm/z)	0.088	0.055	Depth of cut (mm)	4	4	Tool life		1.6 X
			Previous	Worldia																												
Cutter	100B08RP90BG15C2WPM	FMP100SB32-BE12-16																														
Cutter diameter (mm)	φ100	φ100																														
Number of teeth	10	16																														
Inserts	BGHXI 5L1 5PCTRHET	BEHW1204EZFR1																														
Grade	PCD	PD10E																														
Cutting speed (m/min)	2513	2513																														
Feed per tooth (mm/z)	0.088	0.055																														
Depth of cut (mm)	4	4																														
Tool life		1.6 X																														

Figure	Processing conditions	Processing parameters																														
	<p>Workpiece: Cylinder block Material: Aluminum alloy + gray cast iron Spindle: Single spindle Maximum speed: 12000RPM Adaptor: HSK63 Processing type: Surface milling Processing time: 1 Surface finish: Rt10</p>	<table border="1"> <thead> <tr> <th></th> <th>Previous</th> <th>Worldia</th> </tr> </thead> <tbody> <tr> <td>Cutter</td> <td>EcoFeed 7-06200-01</td> <td>FMP200SC60-BE12-30</td> </tr> <tr> <td>Cutter diameter (mm)</td> <td>φ200</td> <td>φ200</td> </tr> <tr> <td>Number of teeth</td> <td>28</td> <td>30</td> </tr> <tr> <td>Inserts</td> <td>—</td> <td>BEHW1204EZFR1</td> </tr> <tr> <td>Grade</td> <td>PCD</td> <td>PD32E</td> </tr> <tr> <td>Cutting speed (m/min)</td> <td>785</td> <td>785</td> </tr> <tr> <td>Feed per tooth (mm/z)</td> <td>0.051</td> <td>0.048</td> </tr> <tr> <td>Depth of cut (mm)</td> <td>0.5</td> <td>0.5</td> </tr> <tr> <td>Tool life</td> <td></td> <td>2.35 X</td> </tr> </tbody> </table>		Previous	Worldia	Cutter	EcoFeed 7-06200-01	FMP200SC60-BE12-30	Cutter diameter (mm)	φ200	φ200	Number of teeth	28	30	Inserts	—	BEHW1204EZFR1	Grade	PCD	PD32E	Cutting speed (m/min)	785	785	Feed per tooth (mm/z)	0.051	0.048	Depth of cut (mm)	0.5	0.5	Tool life		2.35 X
			Previous	Worldia																												
Cutter	EcoFeed 7-06200-01	FMP200SC60-BE12-30																														
Cutter diameter (mm)	φ200	φ200																														
Number of teeth	28	30																														
Inserts	—	BEHW1204EZFR1																														
Grade	PCD	PD32E																														
Cutting speed (m/min)	785	785																														
Feed per tooth (mm/z)	0.051	0.048																														
Depth of cut (mm)	0.5	0.5																														
Tool life		2.35 X																														

Application Case Studies and Worldia Recommendations

Other Vehicle Components

Figure	Processing conditions	Processing parameters		
	Workpiece: Cylinder head cover Material: AISI9Cu3 Spindle: Single spindle Maximum speed: 10000RPM Adaptor: BT40 Processing type: Surface milling Surface finish: Ra3.2			
			Previous	Worldia
		Cutter	FTP063R050A	FMP63SA22-BE12-10
		Cutter diameter (mm)	φ63	φ63
		Number of teeth	5	10
		Inserts	TMCPA01RRB5	BEHW1204EZTR1
		Grade	Alloy (rough) PCD (finish)	PD10E
		Cutting tips	2	
		Cutting speed (m/min)	1484	1682
		Feed per tooth (mm/z)	0.125	0.071
		Depth of cut (mm)	Ap1=5 (alloy) AP2=1 (PCD)	6
		Tools life		1.2 X

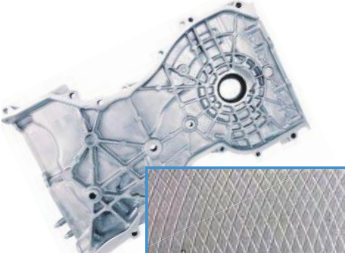

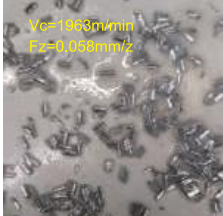

Figure	Processing conditions	Worldia	
	Workpiece: Timing chain housing cover Material: ADC12 Spindle: Single spindle Maximum speed: 12000 RPM Adaptor: BT40 Surface finish: RZ 8~20(gridline)		
		Cutter	FMP63SA22-BE12-10
		Inserts	BEHW1204PZFR1-UW 8 pcs BEHW1204EZFR1-PT 2 pcs
		Grade	PD10E
		Cutter diameter (mm)	63
		Number of teeth	10
		Cutting speed (m/min)	1188
		Feed per tooth (mm/z)	0.1
		Depth of cut(mm)	0.2

Figure	Processing conditions	Worldia	
	Workpiece: Cylinder head Material: ALSi10MgCu Spindle: Single spindle Maximum speed: 16000RPM Machining process: Deck face rough milling Surface finish: Ra3.2 Small chips due to lasered chipbreaker, easy chip removal.		
		Cutter	FMP125SB40-BE12-24
		Inserts	BEHW1204PZTR1-CBR
		Grade	PD10E
		Cutter diameter (mm)	125
		Number of teeth	24
		Cutting speed (m/min)	1963 /1571
		Feed per tooth (mm/z)	0.058 / 0.072
		Depth of cut (mm)	3.5
			 

Application Case Studies and Worldia Recommendations

Cast Iron Components

Figure	Processing conditions	Processing parameters																																	
	<p>Workpiece: Guideways Material: HT250 Spindle: Single spindle Maximum speed: 8000RPM Surface finish: Ra0.4 Hardness: HB180 Surface finish: Ra0.4 Processing time: 1</p>	<table border="1"> <thead> <tr> <th></th> <th>Previous</th> <th>Worldia</th> </tr> </thead> <tbody> <tr> <td>Cutter</td> <td>CBN Milling cutter</td> <td>FMP063SA22-SD07-08</td> </tr> <tr> <td>Cutter diameter (mm)</td> <td>φ63</td> <td>φ63</td> </tr> <tr> <td>Number of teeth</td> <td>1</td> <td>4</td> </tr> <tr> <td>Inserts</td> <td>CBN cartridge</td> <td>SDHN07T3PPSR4-UW</td> </tr> <tr> <td>Grade</td> <td>CBN</td> <td>PNK3003</td> </tr> <tr> <td>Cutting speed (m/min)</td> <td>158</td> <td>499</td> </tr> <tr> <td>Feed per tooth (mm/z)</td> <td>0.25</td> <td>0.08</td> </tr> <tr> <td>Depth of cut (mm)</td> <td>0.2</td> <td>0.2</td> </tr> <tr> <td>Tool life</td> <td></td> <td>2.6 X</td> </tr> </tbody> </table>		Previous	Worldia	Cutter	CBN Milling cutter	FMP063SA22-SD07-08	Cutter diameter (mm)	φ63	φ63	Number of teeth	1	4	Inserts	CBN cartridge	SDHN07T3PPSR4-UW	Grade	CBN	PNK3003	Cutting speed (m/min)	158	499	Feed per tooth (mm/z)	0.25	0.08	Depth of cut (mm)	0.2	0.2	Tool life		2.6 X			
	Previous	Worldia																																	
Cutter	CBN Milling cutter	FMP063SA22-SD07-08																																	
Cutter diameter (mm)	φ63	φ63																																	
Number of teeth	1	4																																	
Inserts	CBN cartridge	SDHN07T3PPSR4-UW																																	
Grade	CBN	PNK3003																																	
Cutting speed (m/min)	158	499																																	
Feed per tooth (mm/z)	0.25	0.08																																	
Depth of cut (mm)	0.2	0.2																																	
Tool life		2.6 X																																	
	<p>Workpiece: Cylinder block Material: HT280 Adaptor: HSK100 Hardness: HB200-275 Processing : Bottom surface Processing type: Milling Processing time: 1 Surface finish: Ra3.2</p>	<table border="1"> <thead> <tr> <th></th> <th>Previous</th> <th>Worldia</th> </tr> </thead> <tbody> <tr> <td>Cutter</td> <td>—</td> <td>FMP160SB32-SD07-20</td> </tr> <tr> <td>Cutter diameter(mm)</td> <td>φ160</td> <td>φ160</td> </tr> <tr> <td>Number of teeth</td> <td>17</td> <td>16</td> </tr> <tr> <td>Inserts</td> <td>Ceramic 14 pcs + PCBN wiper 3 pcs</td> <td>SDHN07T3PPSR4-UW 12 pcs SDHN07T3PPSR4-WG 4 pcs</td> </tr> <tr> <td>Grade</td> <td>CBN</td> <td>PNK3003</td> </tr> <tr> <td>Cutting speed (m/min)</td> <td>452</td> <td>754</td> </tr> <tr> <td>Feed per tooth (mm/z)</td> <td>0.099</td> <td>0.063</td> </tr> <tr> <td>Depth of cut (mm)</td> <td>0.5</td> <td>0.5</td> </tr> <tr> <td>Tool life</td> <td></td> <td>4.5 X</td> </tr> </tbody> </table>		Previous	Worldia	Cutter	—	FMP160SB32-SD07-20	Cutter diameter(mm)	φ160	φ160	Number of teeth	17	16	Inserts	Ceramic 14 pcs + PCBN wiper 3 pcs	SDHN07T3PPSR4-UW 12 pcs SDHN07T3PPSR4-WG 4 pcs	Grade	CBN	PNK3003	Cutting speed (m/min)	452	754	Feed per tooth (mm/z)	0.099	0.063	Depth of cut (mm)	0.5	0.5	Tool life		4.5 X			
	Previous	Worldia																																	
Cutter	—	FMP160SB32-SD07-20																																	
Cutter diameter(mm)	φ160	φ160																																	
Number of teeth	17	16																																	
Inserts	Ceramic 14 pcs + PCBN wiper 3 pcs	SDHN07T3PPSR4-UW 12 pcs SDHN07T3PPSR4-WG 4 pcs																																	
Grade	CBN	PNK3003																																	
Cutting speed (m/min)	452	754																																	
Feed per tooth (mm/z)	0.099	0.063																																	
Depth of cut (mm)	0.5	0.5																																	
Tool life		4.5 X																																	
	<p>Workpiece: Cylinder block Material: HT300 Spindle: Single spindle Maximum speed: 6000RPM Adaptor: HSK100 Processing part: Front and rear Processing type: Milling Processing time: 2 Surface finish: Ra3.2</p>	<table border="1"> <thead> <tr> <th></th> <th>Previous</th> <th>Worldia</th> </tr> </thead> <tbody> <tr> <td>Cutter</td> <td>—</td> <td>FMP200SC60-SD07-24</td> </tr> <tr> <td>Cutter diameter (mm)</td> <td>φ200</td> <td>φ200</td> </tr> <tr> <td>Number of teeth</td> <td>16</td> <td>16</td> </tr> <tr> <td>Inserts</td> <td>Ceramic 14 pcs + PCBN wiper 2 pcs</td> <td>SDHN07T3PPSR4-UW 12 pcs SDHN07T3PPSR4-WG 4 pcs</td> </tr> <tr> <td>Grade</td> <td>CBN</td> <td>PNK3003</td> </tr> <tr> <td>Cutting speed (m/min)</td> <td>628</td> <td>754</td> </tr> <tr> <td>Feed per tooth (mm/z)</td> <td>0.15 (rear) 0.144 (front)</td> <td>0.167 (rear) 0.16 (front)</td> </tr> <tr> <td>Depth of cut (mm)</td> <td>0.35/0.15 (rear) 0.25/0.25 (front)</td> <td>0.35/0.15 (rear) 0.25/0.25 (front)</td> </tr> <tr> <td>Cutting length (m)</td> <td>1.8 (rear) 1 (front)</td> <td>1.8 (rear) 1 (front)</td> </tr> <tr> <td>Tool life</td> <td></td> <td>2.5 X</td> </tr> </tbody> </table>		Previous	Worldia	Cutter	—	FMP200SC60-SD07-24	Cutter diameter (mm)	φ200	φ200	Number of teeth	16	16	Inserts	Ceramic 14 pcs + PCBN wiper 2 pcs	SDHN07T3PPSR4-UW 12 pcs SDHN07T3PPSR4-WG 4 pcs	Grade	CBN	PNK3003	Cutting speed (m/min)	628	754	Feed per tooth (mm/z)	0.15 (rear) 0.144 (front)	0.167 (rear) 0.16 (front)	Depth of cut (mm)	0.35/0.15 (rear) 0.25/0.25 (front)	0.35/0.15 (rear) 0.25/0.25 (front)	Cutting length (m)	1.8 (rear) 1 (front)	1.8 (rear) 1 (front)	Tool life		2.5 X
	Previous	Worldia																																	
Cutter	—	FMP200SC60-SD07-24																																	
Cutter diameter (mm)	φ200	φ200																																	
Number of teeth	16	16																																	
Inserts	Ceramic 14 pcs + PCBN wiper 2 pcs	SDHN07T3PPSR4-UW 12 pcs SDHN07T3PPSR4-WG 4 pcs																																	
Grade	CBN	PNK3003																																	
Cutting speed (m/min)	628	754																																	
Feed per tooth (mm/z)	0.15 (rear) 0.144 (front)	0.167 (rear) 0.16 (front)																																	
Depth of cut (mm)	0.35/0.15 (rear) 0.25/0.25 (front)	0.35/0.15 (rear) 0.25/0.25 (front)																																	
Cutting length (m)	1.8 (rear) 1 (front)	1.8 (rear) 1 (front)																																	
Tool life		2.5 X																																	
	<p>Workpiece: Pump body Material: QT500 Spindle: Single spindle Maximum speed: 8000RPM Adaptors: BT40 Processing type: Milling Processing time: 2 Surface finish: Ra1.6</p>	<table border="1"> <thead> <tr> <th></th> <th>Previous</th> <th>Worldia</th> </tr> </thead> <tbody> <tr> <td>Cutter</td> <td>—</td> <td>FMP125SB40-SD07-16</td> </tr> <tr> <td>Cutter diameter (mm)</td> <td>φ125</td> <td>φ125</td> </tr> <tr> <td>Number of teeth</td> <td>1</td> <td>5</td> </tr> <tr> <td>Inserts</td> <td>APKT160408-1N (CBN)</td> <td>SDHN07T3PPSR4-UW 4 pcs SDHN07T3PPSR4-WG 1 pcs</td> </tr> <tr> <td>Grade</td> <td>CBN</td> <td>PNK3003</td> </tr> <tr> <td>Cutting speed (m/min)</td> <td>236</td> <td>785</td> </tr> <tr> <td>Feed per tooth (mm/z)</td> <td>0.083</td> <td>0.038</td> </tr> <tr> <td>Depth of cut (mm)</td> <td>0.5</td> <td>0.5</td> </tr> <tr> <td>Tool life</td> <td></td> <td>5 X</td> </tr> </tbody> </table>		Previous	Worldia	Cutter	—	FMP125SB40-SD07-16	Cutter diameter (mm)	φ125	φ125	Number of teeth	1	5	Inserts	APKT160408-1N (CBN)	SDHN07T3PPSR4-UW 4 pcs SDHN07T3PPSR4-WG 1 pcs	Grade	CBN	PNK3003	Cutting speed (m/min)	236	785	Feed per tooth (mm/z)	0.083	0.038	Depth of cut (mm)	0.5	0.5	Tool life		5 X			
	Previous	Worldia																																	
Cutter	—	FMP125SB40-SD07-16																																	
Cutter diameter (mm)	φ125	φ125																																	
Number of teeth	1	5																																	
Inserts	APKT160408-1N (CBN)	SDHN07T3PPSR4-UW 4 pcs SDHN07T3PPSR4-WG 1 pcs																																	
Grade	CBN	PNK3003																																	
Cutting speed (m/min)	236	785																																	
Feed per tooth (mm/z)	0.083	0.038																																	
Depth of cut (mm)	0.5	0.5																																	
Tool life		5 X																																	

Assembly and Setting Instructions Worldia FMP-BE Indexable Milling Cutters

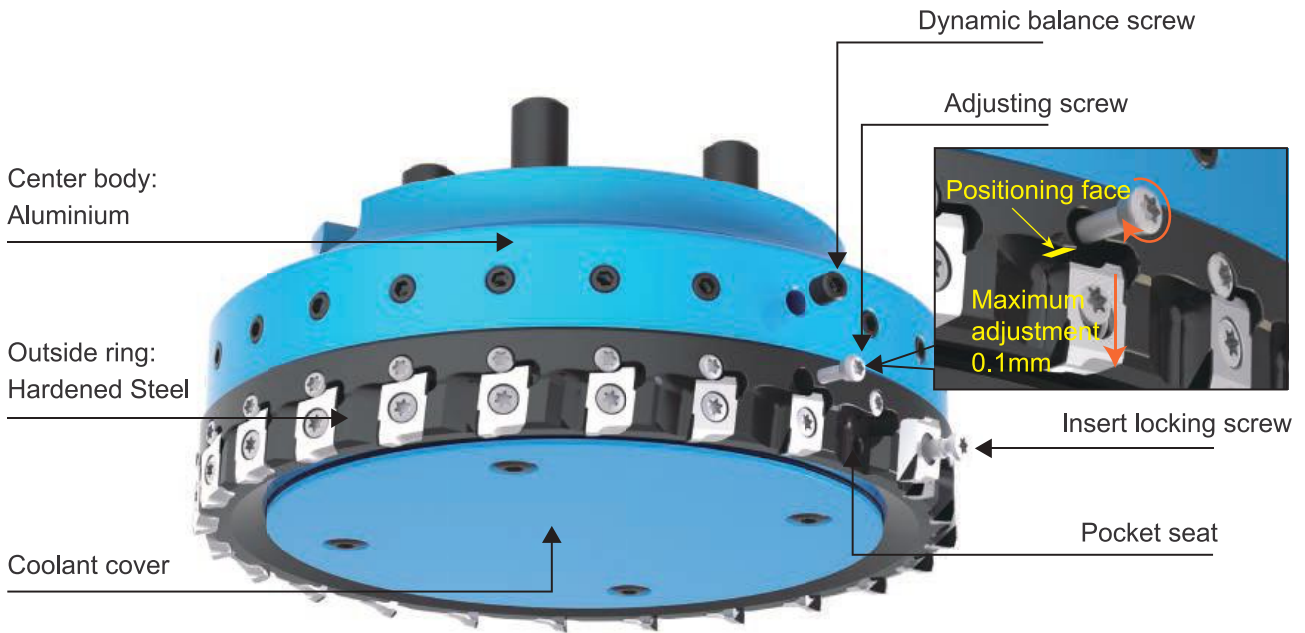

Assembly and Setting Instructions of PCD Milling Cutter

1. Fully unscrew (left-hand) the insert locking screw, and turn the adjusting screw to the left until the head stands out from the steel ring
2. Clean the insert and steel ring, then install the insert into the steel ring and confirm that the positioning face of the insert fits the pre-positioning face
3. Screw in (right-hand) locking screw and tighten to 2.5 Nm
4. Determine which insert is at the highest axial position, and the axial drop of all inserts is ≤ 0.04 mm
5. Turn (right-hand) the adjustment screw, adjust other inserts to move smoothly in the axial direction, and the maximum allowable axial runout error is 2 μ m
6. Tighten the insert locking screw to 3.5 Nm, check again whether the axial runout of the insert is less than 2 μ m, if not, fine adjustment is necessary
7. If there is a combined insert, install the insert according to steps 1-5, adjust the position of the entire set to the required size, and the maximum allowable axial runout error of the insert is 2 μ m

Safety attention:

The cutter has been dynamically balanced before leaving the factory, thus the dynamic balance screw does not need to be adjusted. If you need to adjust the dynamic balance precisely after insert assembly, it is necessary to apply thread lock adhesives for protection!

Roughing: The screw should be replaced every fifth insert change

Finishing: The screw should be replaced every tenth insert change

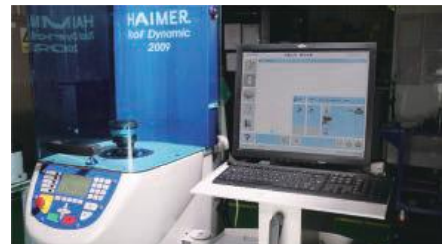

Assembly and Setting Instructions Worldia FMP-SD Indexable Milling Cutters

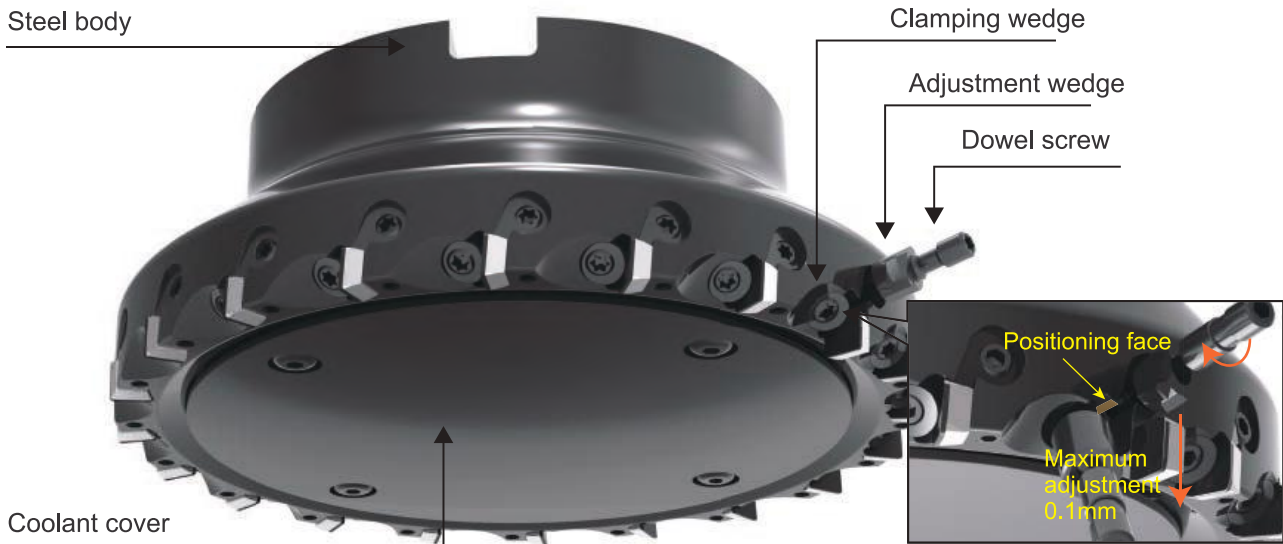

Assembly and Setting Instructions of PCBN Milling Cutter

1. Left turn the screw to loosen the clamping wedge, then turn the dowel screw to the left to loosen the adjustment wedge
2. Install the insert into the cutter body, and confirm that the positioning face of the insert fits the pre-positioning face of the cutter body
3. (Pre-adjustment) Turn the screw to the right to drive the clamping wedge and tighten it to 0.5 Nm
4. (Pre-adjustment) Determine which insert is at the highest position in the insert axial direction
5. (Pre-adjustment) Drive the adjustment wedge to adjust the insert to move smoothly (observe the insert during the process, observe the axial, dimension, lead angle, step 3, 5), the maximum allowable axial runout error is $5\ \mu\text{m}$, lead angle error is $15'$
6. (Fine adjustment) Turn the screw to the right to drive the clamping wedge and tighten it to 2.5 Nm
7. (Fine adjustment) Determine which blade is at the highest position in axial direction
8. (Fine adjustment) Turn the screw to the right to drive the whole block to adjust the blade to move smoothly in axial direction, and the maximum allowable axial runout error is $5\ \mu\text{m}$
9. If there is a combined insert, install the insert according to steps 1-8, adjust the position of the entire set to the required size, and the maximum allowable axial runout error of the insert is $2\ \mu\text{m}$



Worldia Services

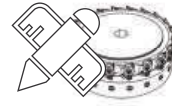

Technology Consulting and Custom Tool Design

After careful study of your requirements, our engineers suggest the most efficient cutting process and tools. If required, we design tools exactly to your needs.

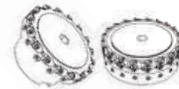

Tool Assembly and Setting

If requested, we assemble the cutters with inserts and adjust them before delivery

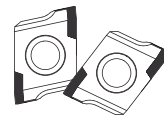

Insert Retipping and Relapping

We offer retipping to same insert size and relapping at attractive conditions

PCD and PCBN Grooving Cutters

Grooving/ Cutting off/ Threading

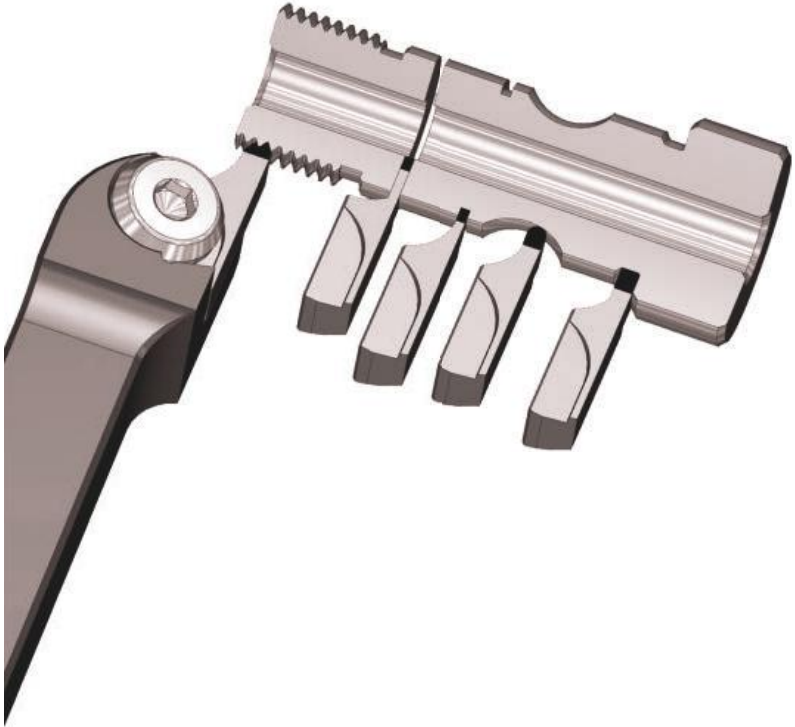

PCD/PCBN Material Introduction

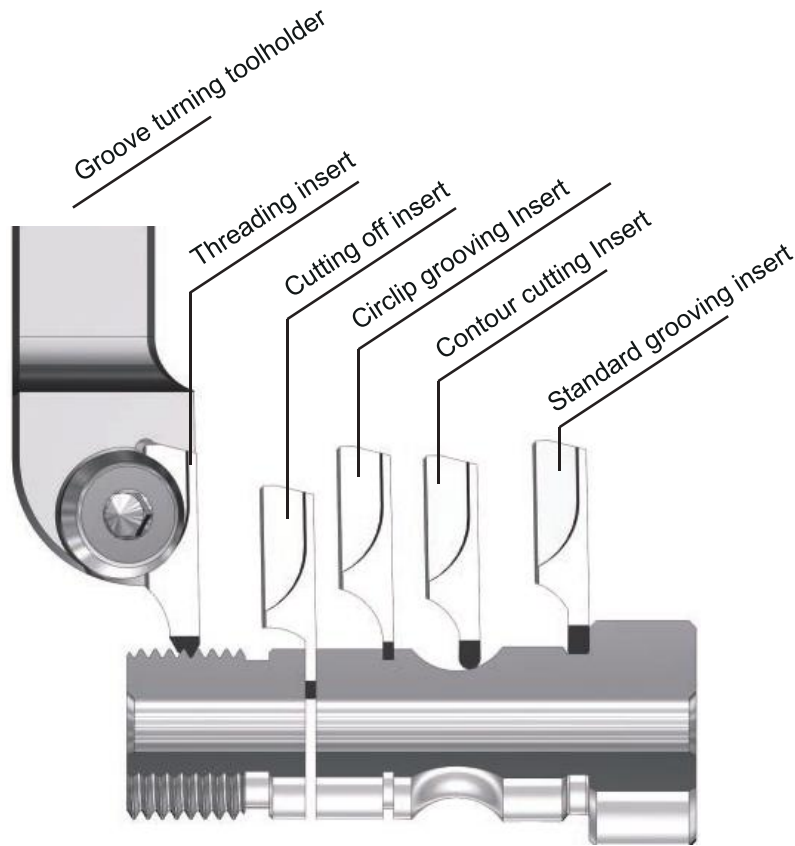



PCD/PCBN Material Introduction

Material	PCD	PCBN			
Type	PD10F	PNH1020	PNH2018	PNH3017	PNK3003
Grian size [μm]	10	1~2	< 1	2	3
Content [Vol.%]	92	60~65	65~70	80~85	90
Binder	—	TiCN	TiN	W、Co	W、Co
Material features	The grade for common applications with excellent impact toughness and wear resistance. Suitable for general finishing of non-ferrous metals; precision machining of cemented carbide, ceramic semi-sintered products, extruded molding; machining of FRP, hard rubber, graphite.	Suitable for continuous and light interrupted machining of hardened steel with the combination of wear and impact resistance.	Suitable for medium interrupted machining of hardened steel with excellent wear and impact toughness	Suitable for heavy interrupted and heavy-duty machining of hardened steel with excellent wear resistance and impact toughness	The high CBN content, excellent wear resistance, and impact toughness make it ideal for machining cast iron.



Grooving Tools Nomenclature

Grooving Tools Code Description



Standard Grooving Inserts

 GTIR Groove turning inserts	 S Standard inserts	 /L Right-hand /Left-hand toolholders	-	W300 Main cutting edge width 3.0	T400 Max cutting depth 4.0	R040 Blade nose radius 0.4	P00 Rake angle 0°
-------------------------------------------------------------------------------------------------------------------------	----------------------------------------------------------------------------------------------------------------	----------------------------------------------------------------------------------------------------------------------------------	---	--------------------------------------------	--------------------------------------	--------------------------------------	-----------------------------



Cut-off Inserts

 GTIO Groove turning inserts		 R/L Right-hand /Left-hand toolholders	-	W200 Main cutting edge width 2.0	T650 Max cutting depth 6.5	R020 Blade nose radius 0.2	P00 Rake angle 0°
-------------------------------------------------------------------------------------------------------------------------	-----------------------------------------------------------------------------------	-----------------------------------------------------------------------------------------------------------------------------------	---	--------------------------------------------	--------------------------------------	--------------------------------------	-----------------------------



Circlip Grooving Inserts

 GTIR Groove turning inserts	 S Specialized groove	 R/L Right-hand /Left-hand toolholders	-	W195 Main cutting edge width 1.95	T400 Max Cutting depth 4.0	R020 Blade nose radius 0.2
-------------------------------------------------------------------------------------------------------------------------	------------------------------------------------------------------------------------------------------------------	-----------------------------------------------------------------------------------------------------------------------------------	---	---------------------------------------------	--------------------------------------	--------------------------------------



Face Grooving Inserts

 GTIE Groove turning inserts		 R/L Right-hand /Left-hand toolholders	--	W300 Main cutting edge width 3.0	T850 Max cutting depth 8.5	R020 Blade nose radius 0.2	B060 Max OD Φ 60	S040 Min OD Φ 40
---------------------------------------------------------------------------------------------------------------------------	-------------------------------------------------------------------------------------	-------------------------------------------------------------------------------------------------------------------------------------	----	--------------------------------------------	--------------------------------------	--------------------------------------	---------------------------------	---------------------------------

Contour Cutting Inserts

 GTIC Groove turning inserts		 R/L Right-hand /Left-hand toolholders	-	R200 Radius 2.0, Cutting width $2x R = 4.0$	T400 Max cutting depth 4.0	P00 Rake angle 0°
---------------------------------------------------------------------------------------------------------------------------	-------------------------------------------------------------------------------------	-------------------------------------------------------------------------------------------------------------------------------------	---	-------------------------------------------------------	--------------------------------------	-----------------------------



Metric Thread Cutting Inserts

 GTIT Groove turning inserts		 R/L Right-hand /Left-hand Toolholders	-	M60 Metric 60°	P100 Thread pitch 1.0mm
---------------------------------------------------------------------------------------------------------------------------	-------------------------------------------------------------------------------------	-------------------------------------------------------------------------------------------------------------------------------------	---	--------------------------	-----------------------------------

Inch thread cutting Inserts

 GTIT Groove turning inserts		 R/L Right-hand /Left-hand toolholders	-	I55N Inch 55°	11 11 teeth per inch
---------------------------------------------------------------------------------------------------------------------------	-------------------------------------------------------------------------------------	-------------------------------------------------------------------------------------------------------------------------------------	---	-------------------------	--------------------------------

Groove Turning Toolholders

 GTHR Groove turning toolholders		/L Cutting Direction Right-hand direction Left-hand direction	-	 C91 Shank tool cutting edge angle 91°	S2020 Tool holder size b=20, h=20
-------------------------------------------------------------------------------------------------------------------------------	-------------------------------------------------------------------------------------	----------------------------------------------------------------------------	---	-------------------------------------------------------------------------------------------------------------------------------------	---------------------------------------------

Grooving Tools Nomenclature

Cutting edge design				Grade
S Edge chamfering + honing	010 Chamfer width 0.1	20 Chamfer angle 20°	05 Rounding R0.005	- PNH1020 Tool nose material
T Edge chamfering	010 Chamfer width 0.1	20 Chamfer angle 20°		- PNH1020 Tool nose material
E Edge honing			05 Rounding R0.005	- PNH1020 Tool nose material
F Edge sharpness				- PNH1020 Tool nose material



Standard Grooving Inserts

① GTI Groove turning inserts	② S Standard inserts	③ R/L Right-hand /Left-hand toolholders	-	④ W300 Main cutting edge width 3.0	⑤ T400 Max cutting depth 4.0	⑥ R040 Blade nose radiu 0.4	⑦ P00 Rake angle 0°
-------------------------------------------	-----------------------------------	------------------------------------------------------	---	-------------------------------------------------	-------------------------------------------	------------------------------------------	----------------------------------

- Fig: Right hand
- Material: PCD

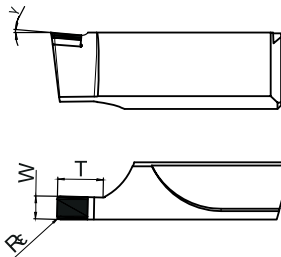

- Material: PCD
- PCBN

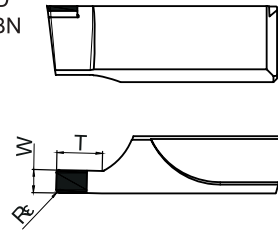

- Allowable feed direction
- Traversing cutting



Right hand Left hand

Material group	N			H			K		
Application	○	◐	⊕	○	◐	⊕	○	◐	⊕
Cutting edge design	F			S0102005			S0102005		

Right hand inserts						WORLDIA PCD		WORLDIA PCBN			
No.	Type	W	T	Rε	Y°	PD10F	PNH1020	PNH2018	PNH3017	PNK3003	
1	GTISR-W300T500R020P00	3	5	0.2	0		▲	▲	▲	▲	
2	GTISR-W300T500R020P05	3	5	0.2	5	▲					
3	GTISR-W350T500R020P00	3.5	5	0.2	0		▲	▲	▲	▲	
4	GTISR-W350T500R020P05	3.5	5	0.2	5	▲					
5	GTISR-W400T500R040P00	4	5	0.4	0		▲	▲	▲	▲	
6	GTISR-W400T500R040P05	4	5	0.4	5	▲					
7	GTISR-W450T500R040P00	4.5	5	0.4	0		▲	▲	▲	▲	
8	GTISR-W450T500R040P05	4.5	5	0.4	5	▲					
Left hand inserts						WORLDIA PCD		WORLDIA PCBN			
No.	Type	W	T	Rε	Y°	PD10F	PNH1020	PNH2018	PNH3017	PNK3003	
1	GTISL-W300T500R020P00	3	5	0.2	0		▲	▲	▲	▲	
2	GTISL-W300T500R020P05	3	5	0.2	5	▲					
3	GTISL-W350T500R020P00	3.5	5	0.2	0		▲	▲	▲	▲	
4	GTISL-W350T500R020P05	3.5	5	0.2	5	▲					
5	GTISL-W400T500R040P00	4	5	0.4	0		▲	▲	▲	▲	
6	GTISL-W400T500R040P05	4	5	0.4	5	▲					
7	GTISL-W450T500R040P00	4.5	5	0.4	0		▲	▲	▲	▲	
8	GTISL-W450T500R040P05	4.5	5	0.4	5	▲					

Circlip Grooving Inserts

① GTI Groove turning inserts	② R Specialized groove	③ R/L Right-hand /Left-hand toolholders	-	④ W195 Main cutting edge width 1.95	⑤ T400 Max cutting depth 4.0	⑥ R020 Blade nose radius angle 0.2
-------------------------------------------	-------------------------------------	------------------------------------------------------	---	--------------------------------------------------	-------------------------------------------	-------------------------------------------------

- Fig: Right hand
- Material: PCD/PCBN

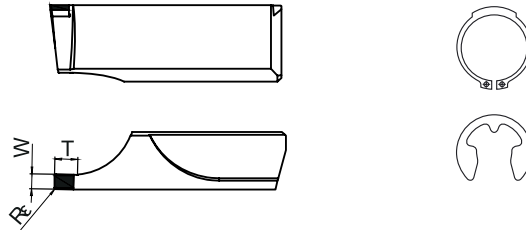

- Allowable feed direction

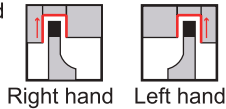

Material group	N			H			K		
Application									
Cutting edge design	F			S0102005			S0102005		

Right hand inserts					WORLDIA PCD		WORLDIA PCBN			
No.	Type	W	T	Rε	PD10F	PNH1020	PNH2018	PNH3017	PNK3003	
1	GTIRR-W140T400R020	1.4	2	0.2	▲	▲	▲	▲	▲	
2	GTIRR-W170T400R020	1.7	3	0.2	▲	▲	▲	▲	▲	
3	GTIRR-W195T400R020	1.95	3	0.2	▲	▲	▲	▲	▲	
4	GTIRR-W225T500R020	2.25	3	0.2	▲	▲	▲	▲	▲	
Left hand inserts					WORLDIA PCD		WORLDIA PCBN			
No.	Type	W	T	Rε	PD10F	PNH1020	PNH2018	PNH3017	PNK3003	
1	GTIRL-W140T400R020	1.4	2	0.2	▲	▲	▲	▲	▲	
2	GTIRL-W170T400R020	1.7	3	0.2	▲	▲	▲	▲	▲	
3	GTIRL-W195T400R020	1.95	3	0.2	▲	▲	▲	▲	▲	
4	GTIRL-W225T500R020	2.25	3	0.2	▲	▲	▲	▲	▲	

Cutting off Inserts

① GTI Groove turning inserts	② O Cut-off inserts	③ R/L Right-hand /Left-hand toolholders	-	④ W200 Main cutting edge width 2.0	⑤ T650 Max cutting depth 6.5	⑥ R020 Blade nose radius angle 0.2	⑦ P00 Rake angle 0°
-------------------------------------------	----------------------------------	------------------------------------------------------	---	-------------------------------------------------	-------------------------------------------	-------------------------------------------------	----------------------------------

- Fig: Right hand
- Material: PCD

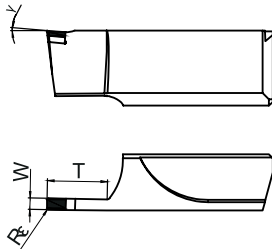

- Material: PCD
- Material: PCBN

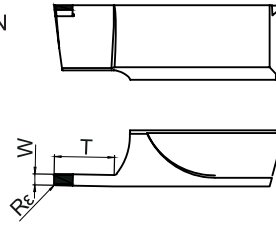

- Allowable feed direction



Right hand



Left hand

Material group	N			H			K		
Application									
Cutting edge design	F			S0102005			S0102005		

Right hand inserts						WORLDIA PCD		WORLDIA PCBN			
No.	Type	W	T	Rε	γ°	PD10F	PNH1020	PNH2018	PNH3017	PNK3003	
1	GTIOR-W150T700R020P00	1.5	7	0.2	0		▲	▲	▲	▲	
2	GTIOR-W150T700R020P05	1.5	7	0.2	5	▲					
3	GTIOR-W200T700R020P00	2	7	0.2	0		▲	▲	▲	▲	
4	GTIOR-W200T700R020P05	2	7	0.2	5	▲					
5	GTIOR-W250T850R020P00	2.5	8.5	0.2	0		▲	▲	▲	▲	
6	GTIOR-W250T850R020P05	2.5	8.5	0.2	5	▲					
7	GTIOR-W300T850R020P00	3	8.5	0.2	0		▲	▲	▲	▲	
8	GTIOR-W300T850R020P05	3	8.5	0.2	5	▲					
Left hand inserts						WORLDIA PCD		WORLDIA PCBN			
No.	Type	W	T	Rε	γ°	PD10F	PNH1020	PNH2018	PNH3017	PNK3003	
1	GTIOL-W150T700R020P00	1.5	7	0.2	0		▲	▲	▲	▲	
2	GTIOL-W150T700R020P05	1.5	7	0.2	5	▲					
3	GTIOL-W200T700R020P00	2	7	0.2	0		▲	▲	▲	▲	
4	GTIOL-W200T700R020P05	2	7	0.2	5	▲					
5	GTIOL-W250T850R020P00	2.5	8.5	0.2	0		▲	▲	▲	▲	
6	GTIOL-W250T850R020P05	2.5	8.5	0.2	5	▲					
7	GTIOL-W300T850R020P00	3	8.5	0.2	0		▲	▲	▲	▲	
8	GTIOL-W300T850R020P05	3	8.5	0.2	5	▲					

Groove Turning Toolholders

① GTI Groove turning inserts	② T Threading inserts	③ R/L Right-hand /Left-hand Toolholders	-	④ M60 Metric 60°	⑤ P100 Thread pitch 1.0mm
-------------------------------------------	------------------------------------	------------------------------------------------------	---	-------------------------------	----------------------------------------

- Fig: Right hand
- Material: PCD/PCBN

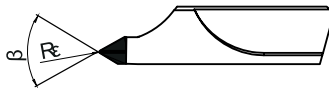
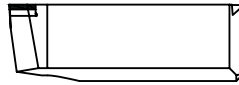

- Allowable feed direction



Right hand Left hand

Material group	N			H			K		
Application	○	◐	⊕	○	◐	⊕	○	◐	⊕
Cutting edge design	F			S0102005			S0102005		

Right hand inserts					WORLDIA PCD		WORLDIA PCBN			
No.	Type	P	A	Rε	PD10F	PNH1020	PNH2018	PNH3017	PNK3003	
1	GTITR-M60P100	1.00	60	0.12	▲	▲	▲	▲	▲	
2	GTITR-M60P150	1.50	60	0.18	▲	▲	▲	▲	▲	
3	GTITR-M60P200	2.00	60	0.25	▲	▲	▲	▲	▲	
Left hand inserts					WORLDIA PCD		WORLDIA PCBN			
No.	Type	P	A	Rε	PD10F	PNH1020	PNH2018	PNH3017	PNK3003	
1	GTITL-M60P100	1.00	60	0.12	▲	▲	▲	▲	▲	
2	GTITL-M60P150	1.50	60	0.18	▲	▲	▲	▲	▲	
3	GTITL-M60P200	2.00	60	0.25	▲	▲	▲	▲	▲	

Groove Turning Toolholders

① GTH Groove turning Toolholders	② R/L Cutting Direction: Right-hand direction Left-hand direction	-	③ C91 Shank tool cutting edge angle 91°	④ S2020 Tool holder size b=20, h=20
-----------------------------------------------	--------------------------------------------------------------------------------------	---	------------------------------------------------------	--------------------------------------------------

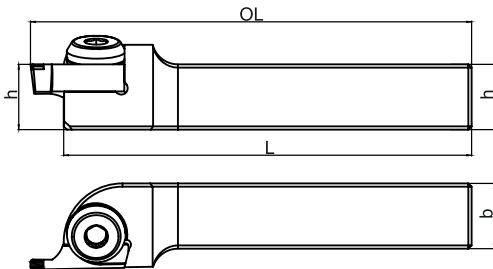

- Fig: Right hand

No.	Type	b	h	L	OL
1	GTHR-C91S2020	20	20	125	135
2	GTHL-C91S2020	20	20	125	135
3	GTHR-C91S2525	25	25	150	160
4	GTHL-C91S2525	25	25	150	160

Customized Grooving Inserts

GTIR Contour Cutting Inserts

① GTI Groove turning inserts	② C Contour cutting Inserts	③ R/L Right-hand /Left-hand toolholders	-	④ R200 Radius 2.0, Cutting width $2x R = 4.0$	⑤ T400 Max Cutting depth 4.0	⑥ P00 Rake angle 0°
-------------------------------------------	------------------------------------------	------------------------------------------------------	---	------------------------------------------------------------	-------------------------------------------	-----------------------------------------

- Fig: Right hand
- Material: PCD/PCBN
- Allowable feed direction



Right hand

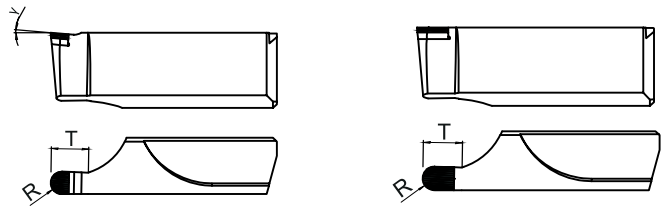

GTIE End Face Ring Grooving Inserts

① GTI Groove turning inserts	② E End face ring groove	③ R/L Right-hand /Left-hand toolholders	-	④ W300 Main cutting edge width 3.0	⑤ T850 Max Cutting depth 8.5	⑥ R020 Blade nose radius angle 0.2	-	⑦ B060 Max OD $\Phi 60$	⑧ S040 Min OD $\Phi 40$
-------------------------------------------	---------------------------------------	------------------------------------------------------	---	-------------------------------------------------	-------------------------------------------	-------------------------------------------------	---	--------------------------------------	--------------------------------------

- Fig: Right hand
- Material: PCD/PCBN
- Allowable feed direction



Right hand

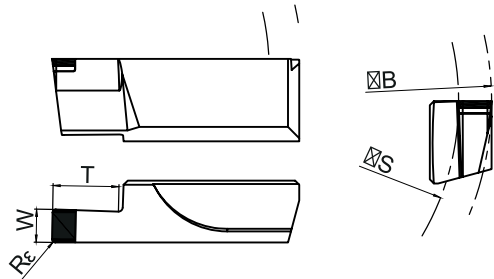

GTIT Metric Threading Inserts

① GTI Groove turning inserts	② T Threading inserts	③ R/L Right-hand /Left-hand toolholders	-	④ M60 Metric 60°	⑤ P100 Thread Pitch 1.0mm
-------------------------------------------	------------------------------------	------------------------------------------------------	---	--------------------------------------	----------------------------------------

- Fig: Right-hand inserts with wiper
- Material: PCD/PCBN
- Allowable feed direction



Right hand

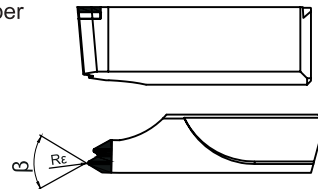

GTIT Inch Threading Inserts

① GTI Groove turning inserts	② T Threading Inserts	③ R/L Right-hand /Left-hand toolholders	-	④ I55 Inch 55°	⑤ N11 11 teeth per inch
-------------------------------------------	------------------------------------	------------------------------------------------------	---	------------------------------------	--------------------------------------

- Fig: Right-hand inserts with wiper
- Material: PCD/PCBN
- Allowable feed direction



Right hand

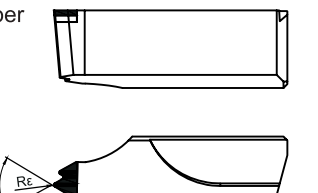

- Fig: Right-hand inserts without wiper
- Material: PCD/PCBN

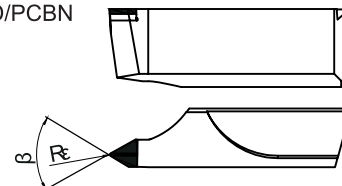

Application Cases



Tool life increased by **1.2** times

PCBN Grooving Cutter Designed for Shaft Grooving

Workpiece: Input shaft
 Material: Hardened steel
 Hardness: HRC58~62
 Surface finish: Ra0.8
 Worldia insert: GTIRL-W225T500R020 PNH2018
 Parameters: VC: 200m/min f: 0.08mm/rev ap: 0.3mm

Comparison of tool life

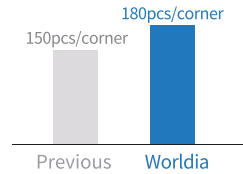

4.2 times longer tool life than pervious tools

Application Case of PCBN Threading Insert

Workpiece: Pulley
 Material: 20CrMnTiH
 Hardness: HRC58~63
 Surface finish: Ra1.6
 Machining parts: external thread
 Operation type: Continuous
 Worldia insert: GTITL-M60P200 PNH2018
 Parameters: Vc:100m/min f: 1mm/rev ap: 0.06mm

Comparison of tool life

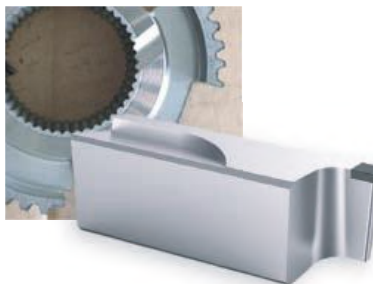
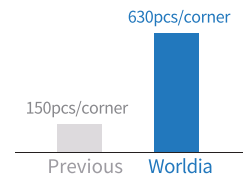

Tool life increased by **1.5** times

Application Case of PCBN Face Grooving Insert

Workpiece: Wheel hub
 Material: Powder metal
 Hardness:HRC40
 Machining size:φ73~φ52
 Machining parts: Face grooving
 Operation type: Continuous & interrupted cutting
 Surface finish:Ra0.8
 Worldia Insert: Customized face grooving insert
 Parameters:Vc:160~224m/min f: 0.11mm/rev ap: 3mm

Comparison of tool life

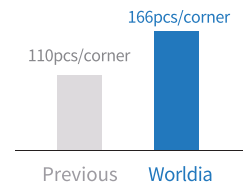

16% increase in machining efficiency
 3 times longer tool life than pervious tools

Application Case of PCBN Grooving Insert

Workpiece: Synchronizer Material:20CrMnTiH
 Hardness:HRC58-62 Machining size:D92
 Surface finish:RZ3.5 Machining parts: Groove
 Operation type: Continuous cutting
 Tool: Grooving cutter

Comparison of tool life

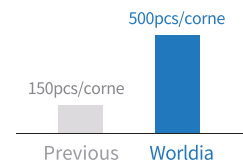

Parameters	Worldia		Previous
	Tool	GTISR-W300T500R020P05 PNH2018	
Cutting depth(mm)	0.15	0.15	
Spindle speed(rev/min)	450/500	645	
Feed(mm/rev)	0.13/0.2	0.1	
Total (s)	42"	50"	



PCD Non-standard Tools





WORLDIA® Specialty Tools Introduction

Products category:

1. Rotating tools: High-precision PCD/PCBN reamers, drill reamers, boring tools, end mills, profile cutters and etc.
2. Interchangeable: Welding/Integrated boring inserts, profile milling inserts, thread Inserts, roller inserts, planer tool;
3. Turning: Profile turning tools, internal/external groove cutters, thread turning tools:
4. Wear-resistant: high-precision PCD supportor, wear-resistant coupling, grinding wheel dresser.

Applications:

1. Processing of related parts and components in the automotive industry such as engines, wheel hubs, and brake disc;
2. Processing of key components in 3C industry, such as mobile phones, notebooks and tablet computers;
3. Processing of cast aluminum/cast iron such as air conditioner compressor housings and drive motors;
4. Processing of composite materials;
5. Processing of non-ferrous products such as resins, rubber, plastics, and semiconductors;
6. Processing of couplings, wear parts and etc. used in the oil drilling industry;
7. Processing of furniture, crafts and other wood-working industry.



Production Equipment

Equipment for specialty tools:

FANUC six-axis high-precision WEDM mainly undertakes the machining of specialty tools such as PCD/PCBN reamers, milling cutters and profile cutters. With the stable performance and reliable accuracy, the machine can keep higher edge and surface quality.

DMG high-precision laser cutting machine mainly undertakes the processing of specialty tools such as PCD/PCBN/CVD, which can ensure high processing precision and good appearance, especially in processing of PCD reamer chip breaker.

The Zoller pre-setting tools can pre-adjust, measure and manage all kinds of cutting tools conveniently and quickly. The equipment is equipped with HEIDENHAIN grating scales. The measurement data is accurate, repeatable and stable in reproducibility.

Z-MIKE laser diameter measuring instrument can collect measurement data automatically, process scientifically, calculate fast with stable measurement accuracy and high efficient measurement.

Haimer balance instrument can carry out single-side and double-side dynamic balance correction on the tool holder. It can achieve the accuracy of micron-level clamping by using laser marking and automatic positioning. The minimum measuring accuracy can be 0.5gmm, the calculation is accurate, and the operation is easy and quick.

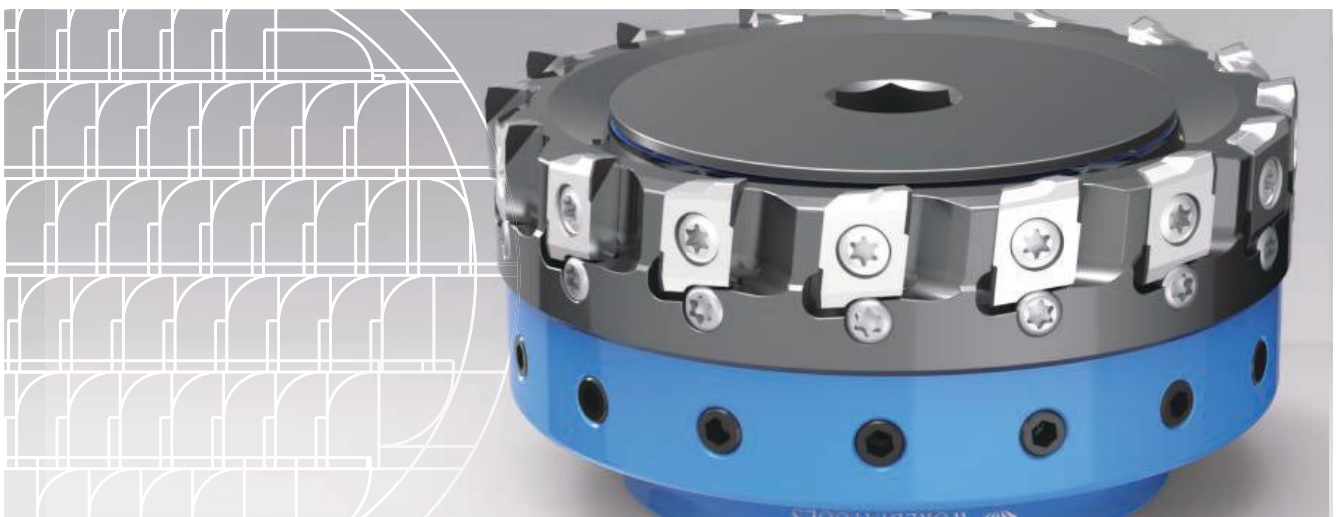

Cylinder Head

PCD SPECIALTY TOOLS
For Auto Parts

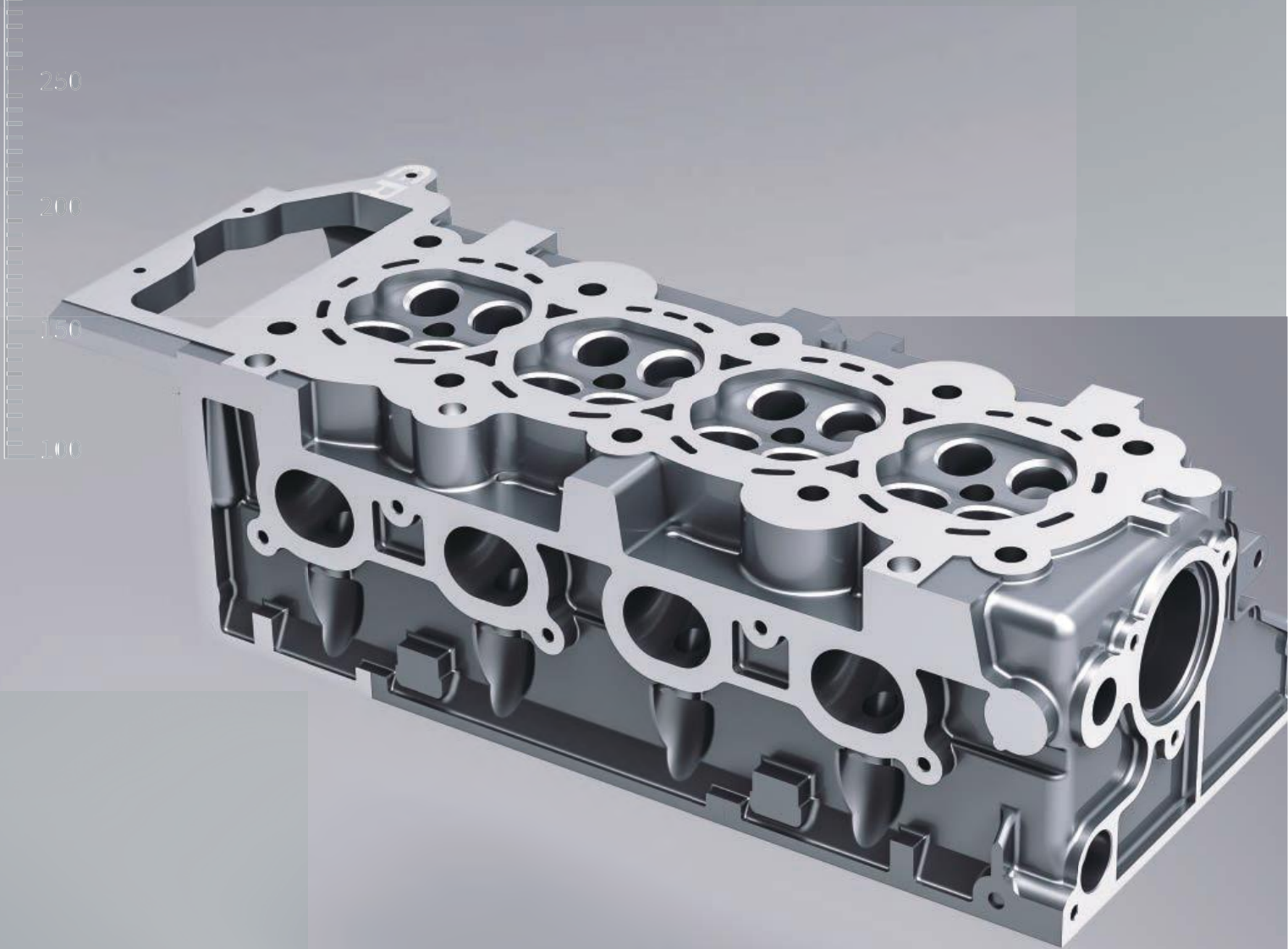

PCD Specialty Tools

Aluminium Alloy Cylinder Head

Face Milling Cutter

S=12000r/min
fz=0.05mm/z



Side and face milling

S=6000r/min
fz=0.03mm/z



Step Drilling Reamer

S=5500r/min
fz=0.12mm/z



End milling reamer

S=4000r/min
fz=0.03mm/z



Step Reamer

S=5500r/min
fz=0.05mm/z



Step Reamer

S=3500r/min
fz=0.02mm/z





Clutch Housing

PCD SPECIALTY TOOLS
For Auto Parts

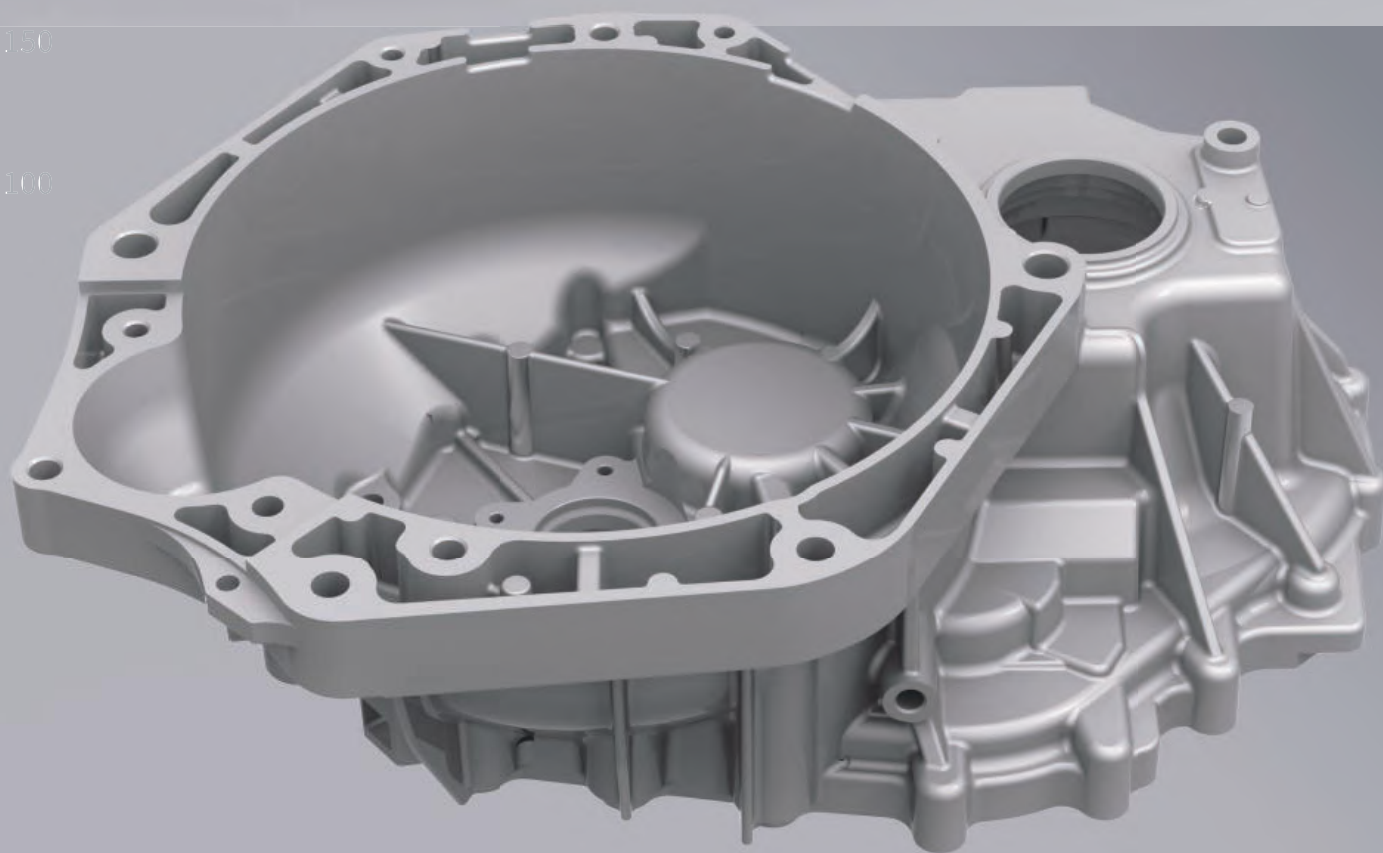

PCD Specialty Tools

Clutch Housing

Face Milling Cutter

S=6000r/min
fz=0.03mm/z



Step boring cutter

S=4000r/min
fz=0.10mm/z



Step Reamer

S=5500r/min
fz=0.12mm/z



Guide bar boring cutter

S=2200r/min
fz=0.08mm/z



Forming milling cutter

S=6500r/min
fz=0.15mm/z



Combination boring cutter

S=3500r/min
fz=0.08mm/z



Gear-box/Oil Pan

PCD SPECIALTY TOOLS
For Auto Parts

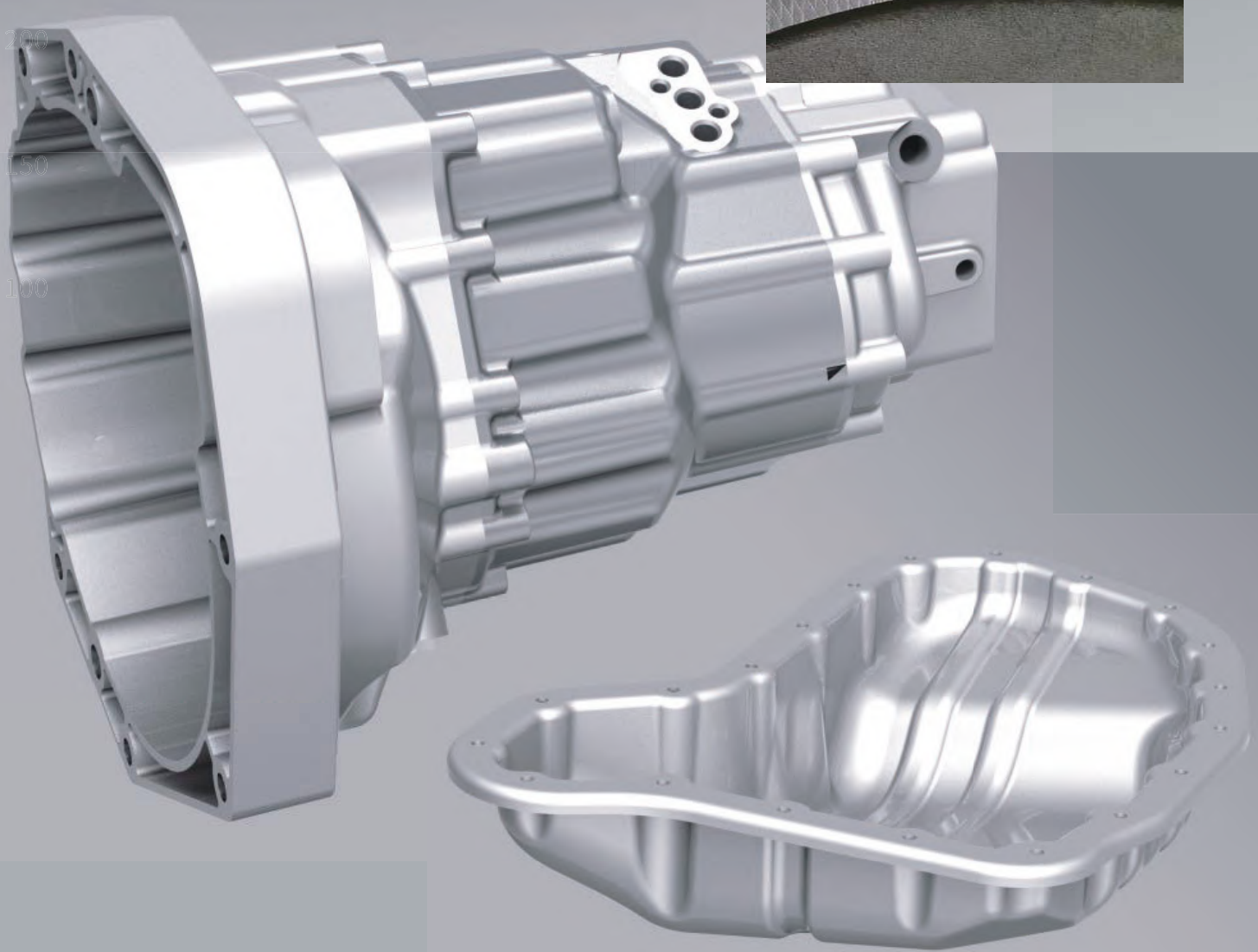
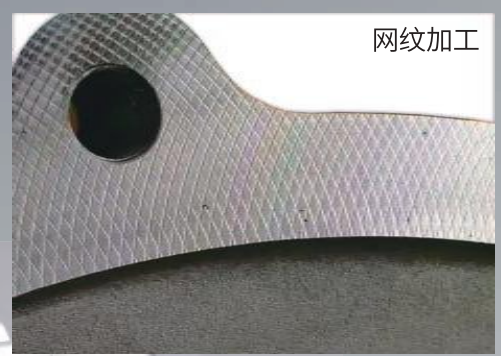

PCD Specialty Tools

Gear Box/Oil Pan

Face Milling Cutter

S=6000r/min
fz=0.03mm/z



Step reamer

S=12000r/min
fz=0.05mm/z



Shell milling reamers

S=3500r/min
fz=0.02mm/z



Step reamer

S=4000r/min
fz=0.04mm/z



Multi-Edge End Mill

S=5500r/min
fz=0.05mm/z





Steering Gear

PCD SPECIALTY TOOLS
For Auto Parts

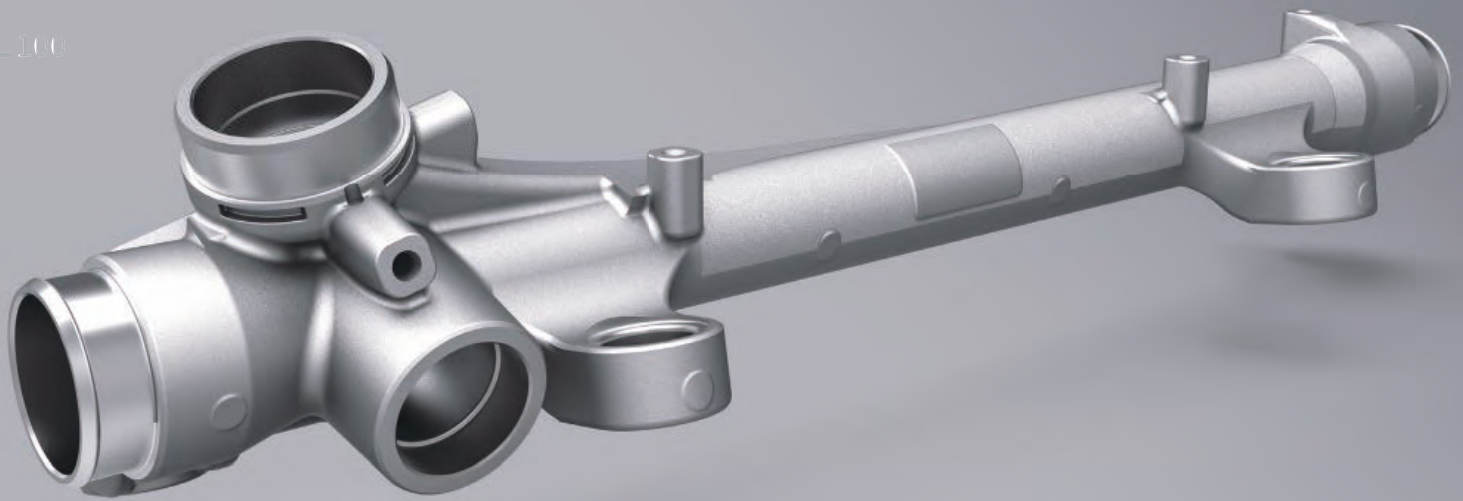

PCD Specialty Tools

Steering Gear

Step Drilling Reamer

S=4500r/min
fz=0.03mm/z



Multi step reamer

S=4000r/min
fz=0.08mm/z



Reverse chamfering milling cutter

S=3500r/min
fz=0.06mm/z



Multi step grooving milling cutter

S=3500r/min
fz=0.03mm/z



One step reamer

S=3500r/min
fz=0.1mm/z



Shell Milling Cutter

S=3500r/min
fz=0.055mm/z

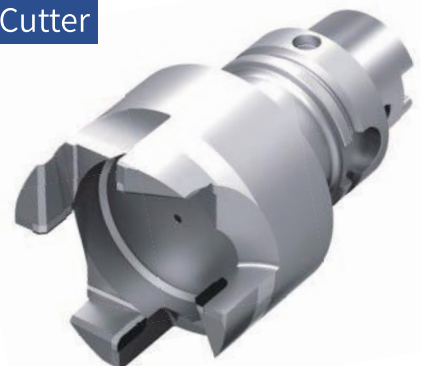

Brake Caliper

PCD SPECIALTY TOOLS
For Auto Parts

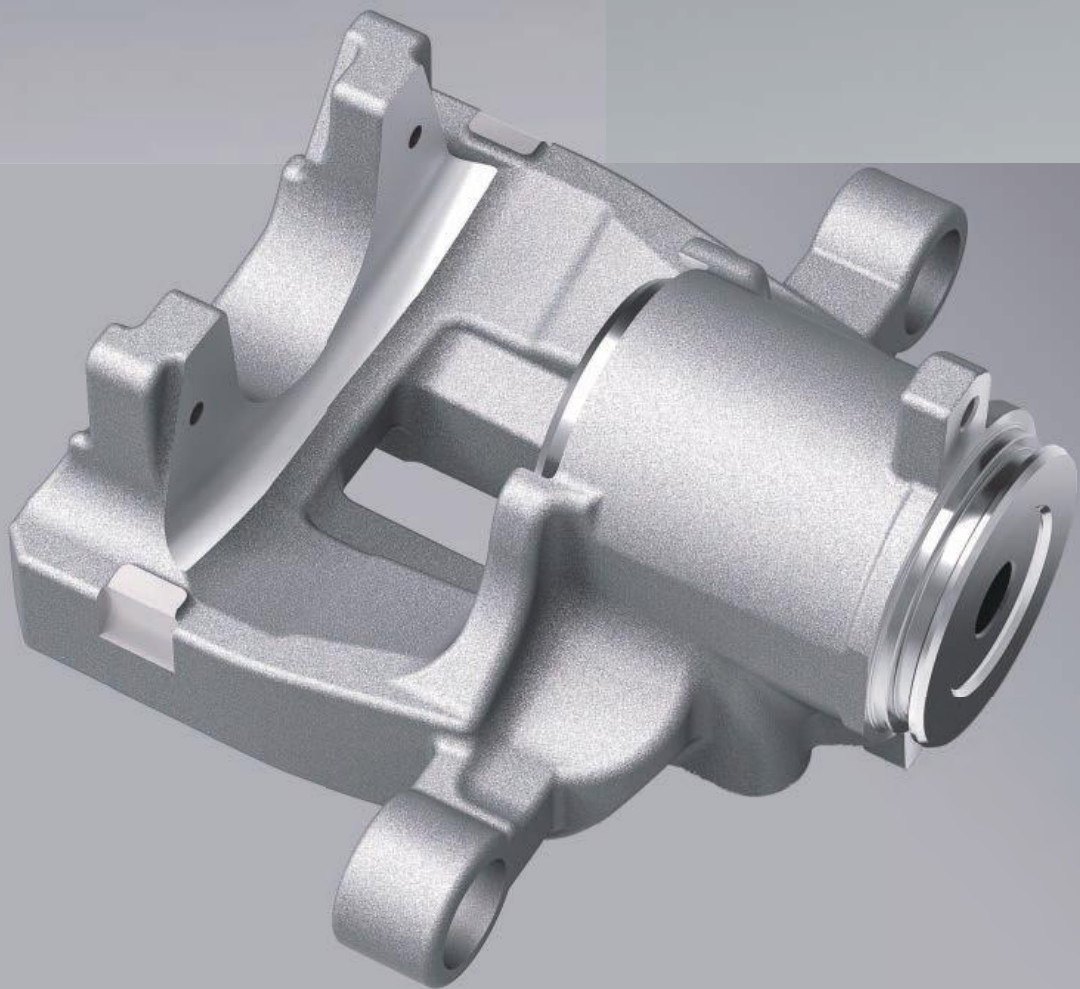

PCD Specialty Tools

Brake Caliper

Side and face milling cutter

S=4500r/min
fz=0.035mm/z



Grooving cutter

S=6500r/min
fz=0.045mm/z



Shell milling grooving cutter

S=6000r/min
fz=0.05mm/z





Throttle Valve

PCD SPECIALTY TOOLS
For Auto Parts

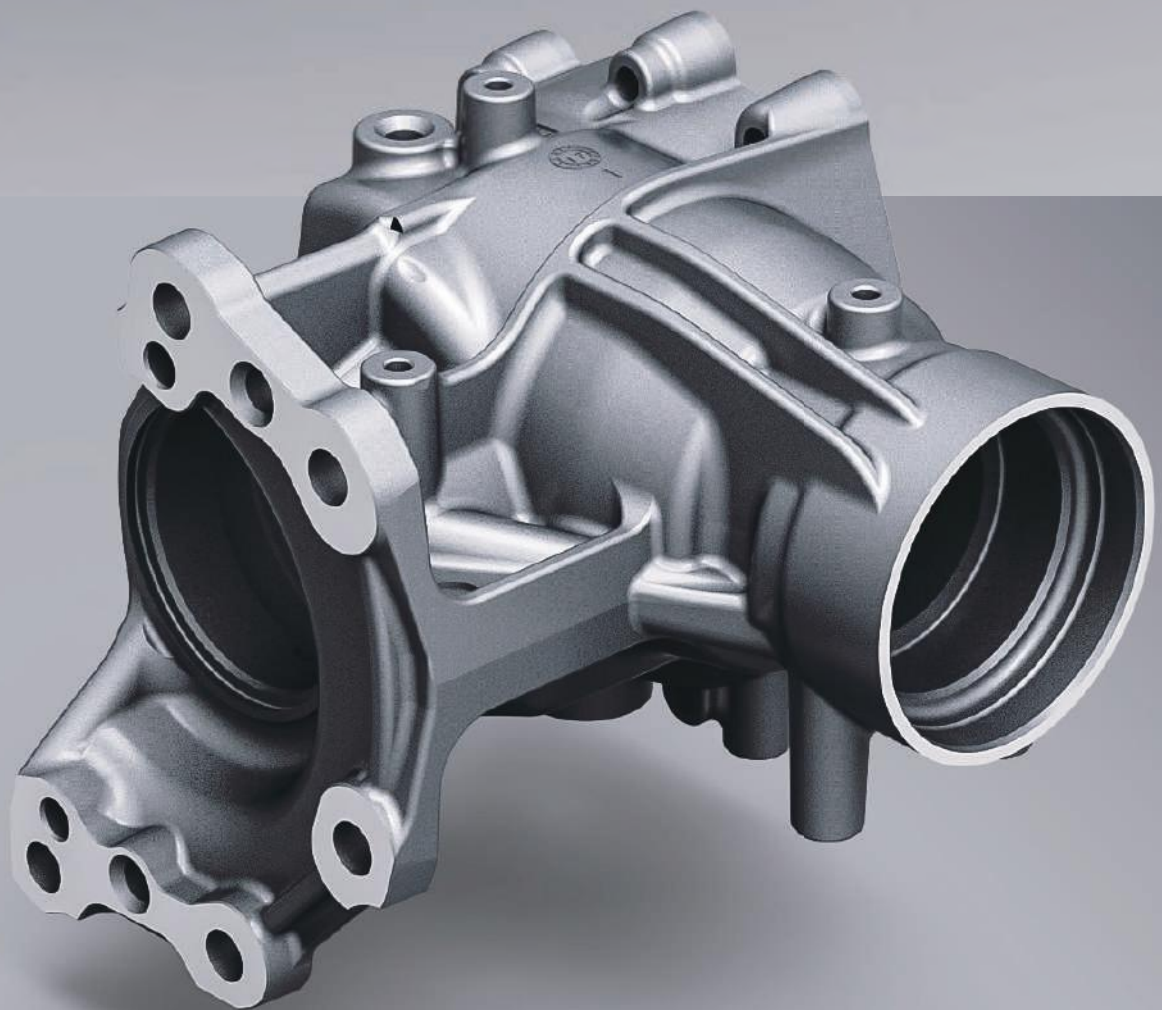

PCD Specialty Tools

Throttle Valve

Forming milling cutter

S=3500r/min
fz=0.045mm/z



Step Drilling Reamer

S=3600r/min
fz=0.015mm/z



Side milling cutter

S=4000r/min
fz=0.055mm/z



Step Drilling Reamer

S=3750r/min
fz=0.025mm/z



Step Reamer

S=4200r/min
fz=0.015mm/z



Throttle Valve

PCD SPECIALTY TOOLS
For Auto Parts

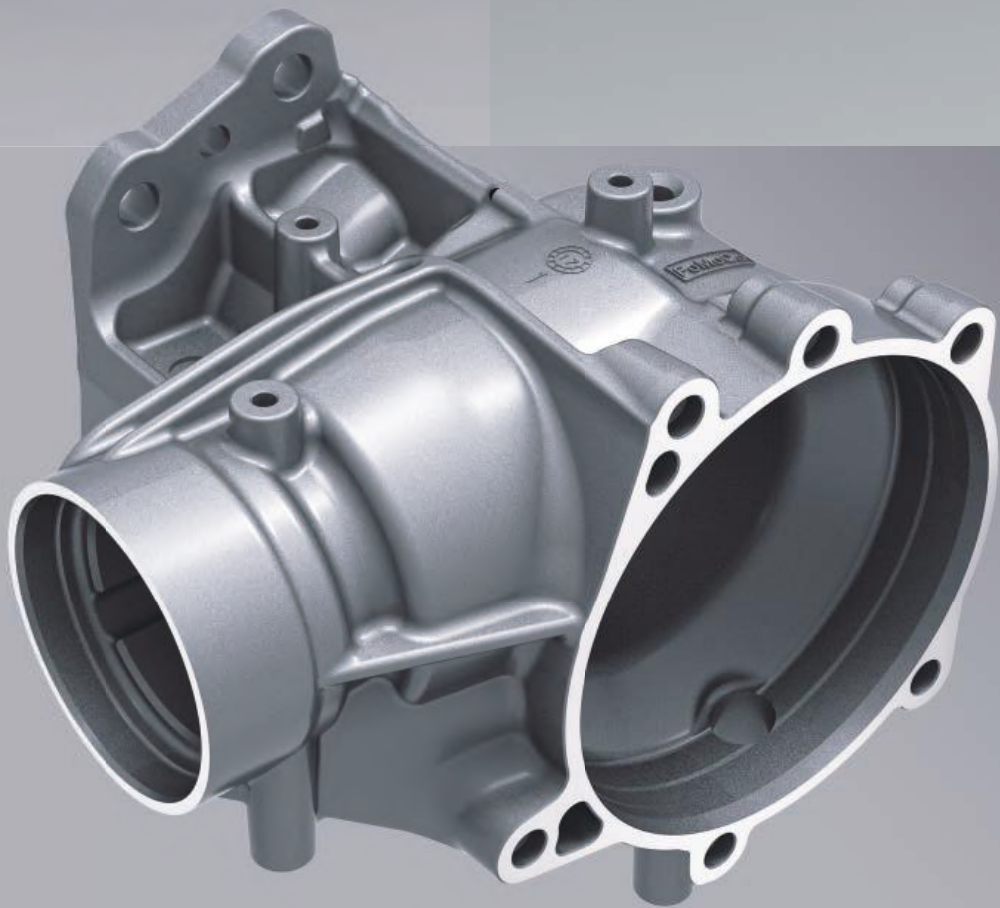

PCD Specialty Tools

Throttle Valve

Dense-tooth multi step reamer

S=8000r/min
fz=0.05mm/z



Deep-hole drilling reamer

S=3500r/min
fz=0.012mm/z



Adjustable precision boring cutter

S=5500r/min
fz=0.05mm/z

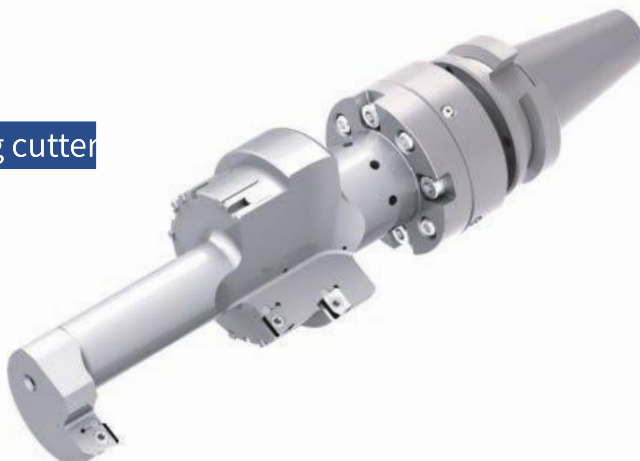



Steering Knuckles

PCD SPECIALTY TOOLS
For Auto Parts

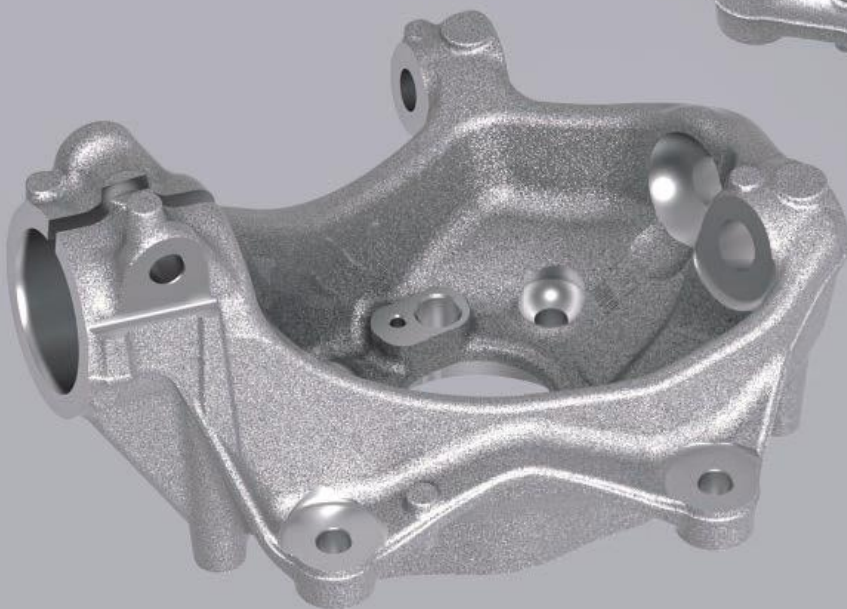
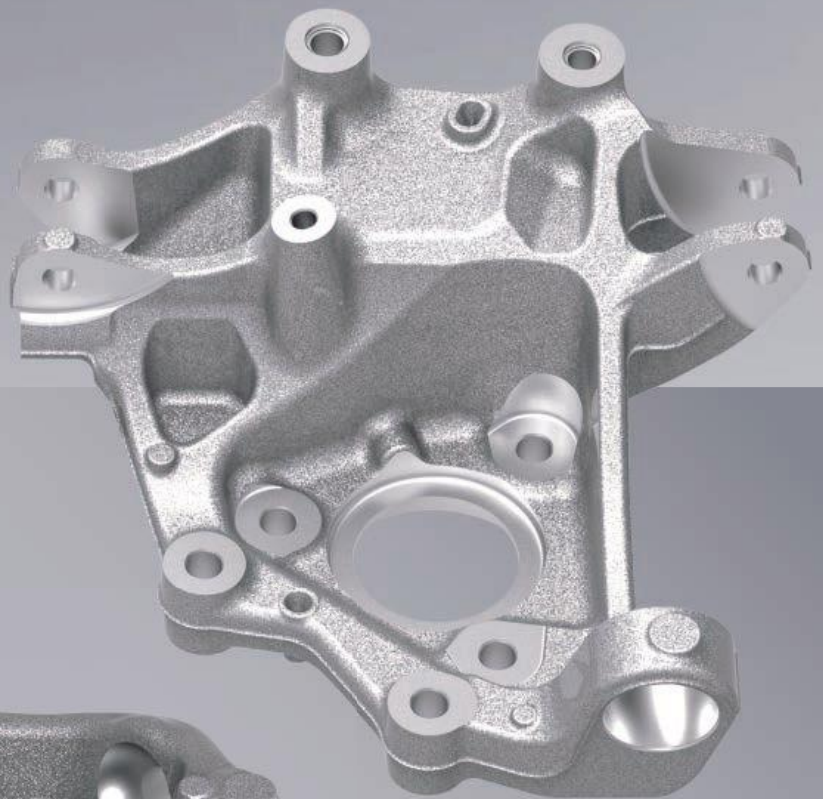

PCD Specialty Tools

Steering Knuckles

Rough&finish drilling Reamer

S=5500r/min
fz=0.09mm/z



Step finish boring cutter

S=2500r/min
fz=0.10mm/z

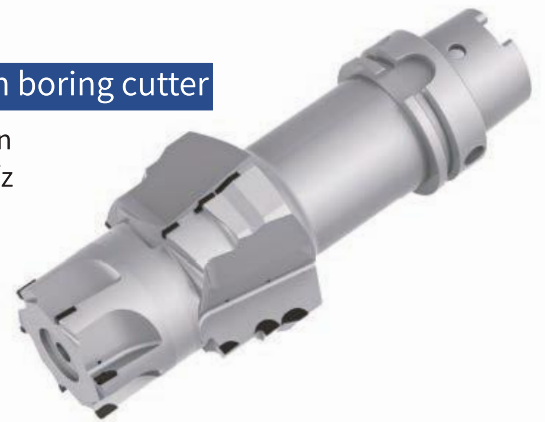

Interchangeable rough boring cutter

S=1800r/min
fz=0.15mm/z

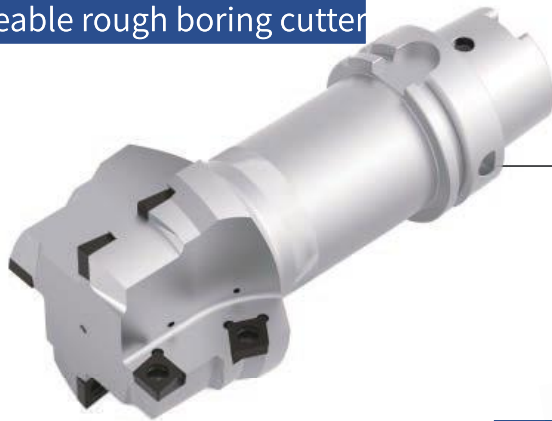

Contour milling cutter

S=3300r/min
fz=0.05mm/z



Step Reamer

S=4200r/min
fz=0.015mm/z



500
450
400
350
300
250
200
150
100

Steering Knuckles

PCD SPECIALTY TOOLS
For Auto Parts

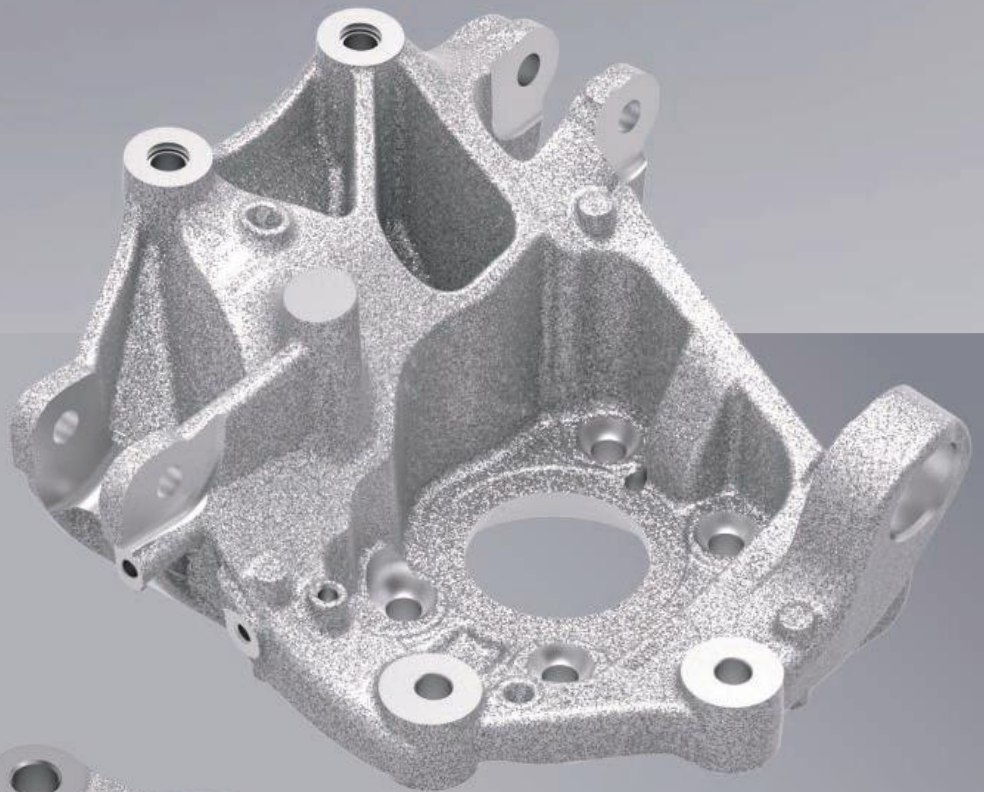

PCD Specialty Tools

Steering Knuckles

4-layer milling cutter

S=3500r/min
fz=0.16mm/z

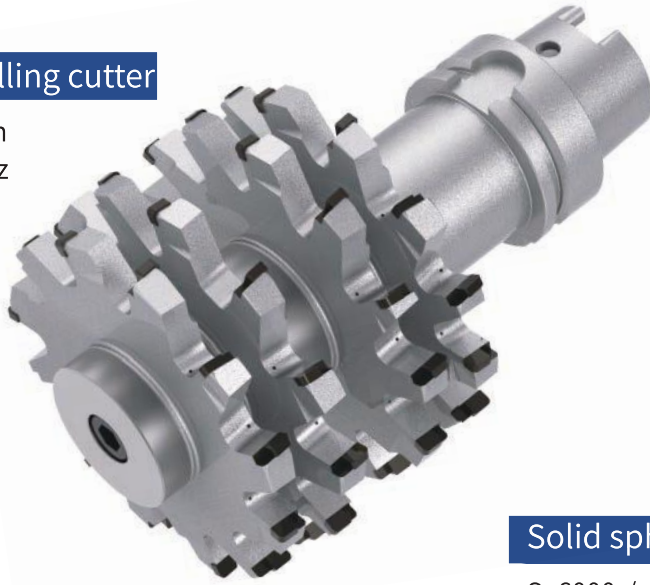

Solid spherical concave milling cutter

S=6000r/min
fz=0.10mm/z



side and face milling cutter

S=2600r/min
fz=0.08mm/z

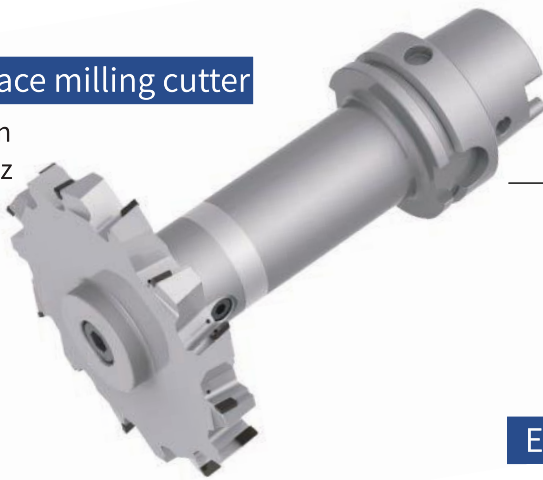

End mill

S=6500r/min
fz=0.08mm/z



500
450
400
350
300
250
200
150
100

Turbocharger

PCD SPECIALTY TOOLS
For Auto Parts



PCD Specialty Tools

Turbocharger housing

Profile contour milling cutter

S=8000r/min
fz=0.15mm/z



Taper milling cutter

S=6000r/min
fz=0.08mm/z



Forming drill

S=4500r/min
fz=0.10mm/z



Forming shell milling cutter

S=4200r/min
fz=0.13mm/z



Step drilling

S=4000r/min
fz=0.10mm/z





Aluminium Products

PCD SPECIALTY TOOLS
For Auto Parts

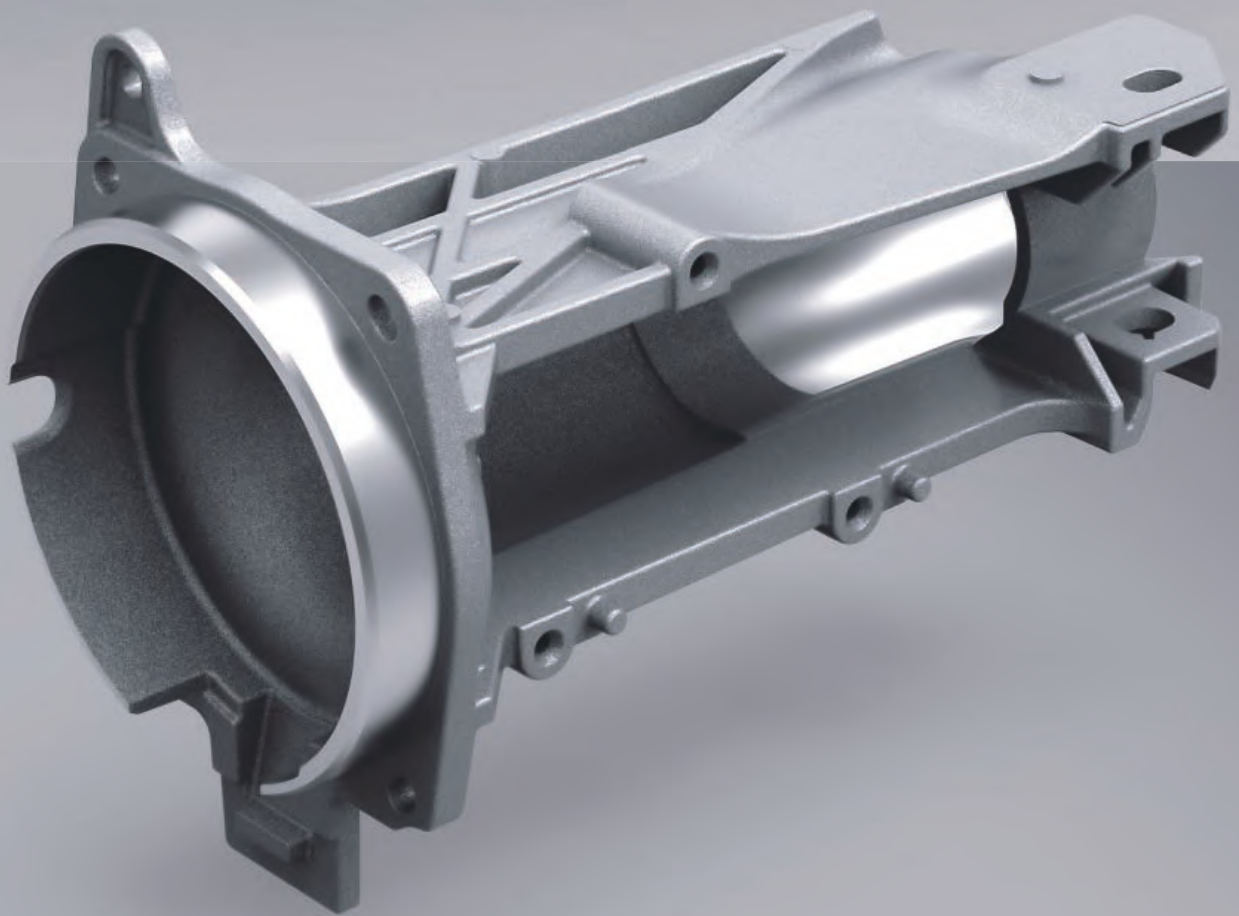

PCD Specialty Tools

Aluminium Products

Reverse milling cutter

S=8000r/min
fz=0.05mm/z



Adjustable precision boring cutter

S=8000r/min
fz=0.035mm/z



Side and face milling cutter

S=8000r/min
fz=0.065mm/z



Scroll Plate

PCD SPECIALTY TOOLS
For Auto Parts

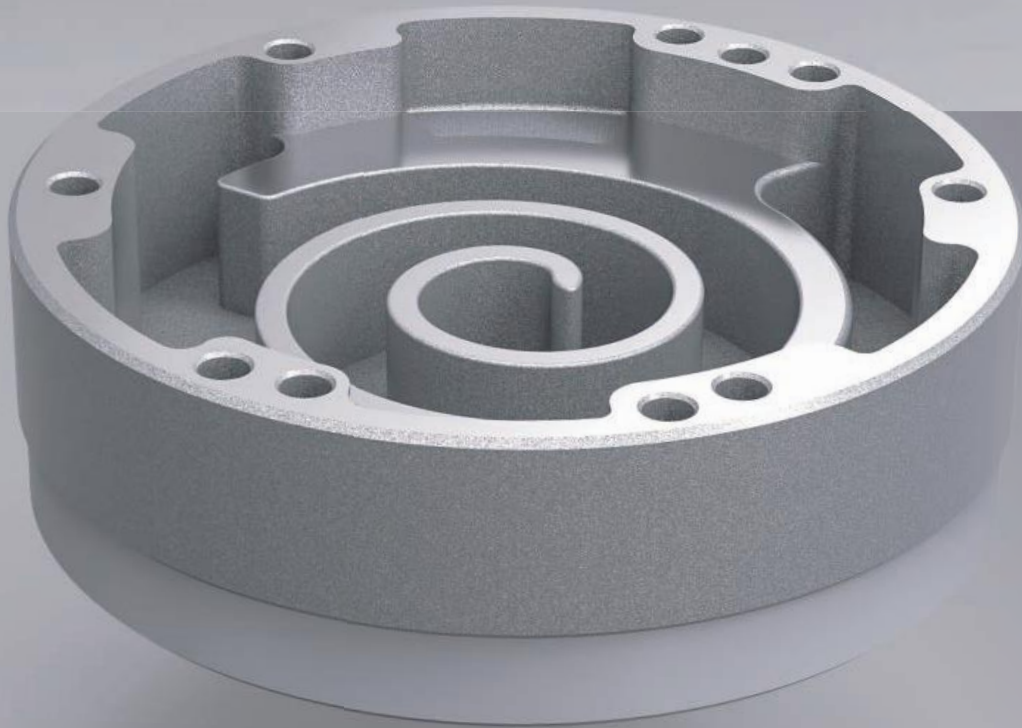

PCD Specialty Tools

Scroll Plate

Drilling Reamer

S=4500r/min
fz=0.05mm/z



Side milling cutter

S=39800r/min
fz=0.10mm/z



Helical milling cutter

S=39800r/min
fz=0.05mm/z



Helical milling cutter

Milling Cutter

PCD SPECIALTY TOOLS
For Auto Parts

Slotted helical milling cutter

S=6000r/min
fz=0.15mm/z



Slotless helical milling cutter

S=8000r/min
fz=0.12mm/z

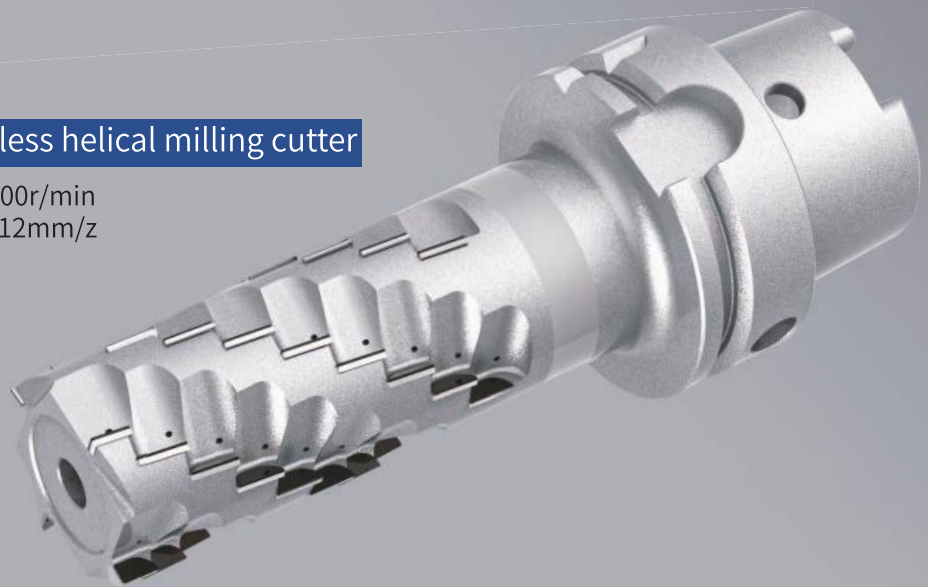

PCD Specialty Tools

Specialty cutters for composite materials

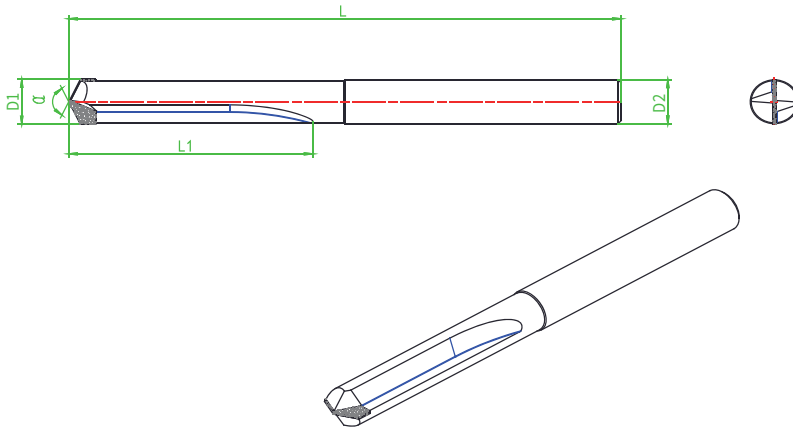

PCD Straight flute drill -- Metric

Type	Specification	D1	L1	D2	L	α	Material
RD1CR00SW-121R	D4*25*SD4*SL65	4	25	4	65	130°	PCD
RD1CR00SW-121R	D5*25*SD6*SL65	5	25	6	65	130°	PCD
RD1CR00SW-121R	D6*25*SD6*SL65	6	25	6	65	130°	PCD
RD1CR00SW-121R	D8*35*SD8*SL82	8	35	8	82	130°	PCD
RD1CR00SW-121R	D10*35*SD10*SL82	10	35	10	82	130°	PCD
RD1CR00SW-121R	D12*35*SD12*SL82	12	35	12	82	130°	PCD
RD1CR00SW-121R	D14*45*SD14*SL108	14	45	14	108	130°	PCD
RD1CR00SW-121R	D16*45*SD16*SL108	16	45	16	108	130°	PCD
RD1CR00SW-121R	D18*45*SD18*SL108	18	45	18	108	130°	PCD
RD1CR00SW-121R	D20*50*SD20*SL108	20	50	20	108	130°	PCD

Customized size

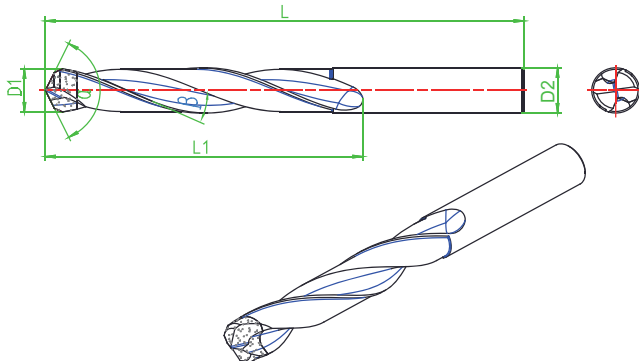

Workpiece

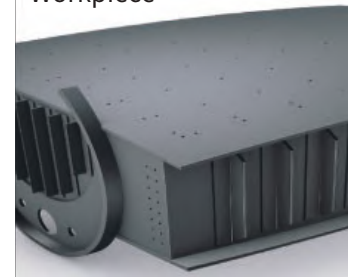

PCD Solid Drill—Metric

Type	Specification	D1	L1	D2	L	α	β	Material
RD1CR00SW-121R	D2.5*25*SD4*SL57	2.5	25	4	57	130°	30°	PCD
RD1CR00SW-121R	D3.0*25*SD4*SL57	3.0	25	4	57	130°	30°	PCD
RD1CR00SW-121R	D3.5*25*SD4*SL57	3.5	25	4	57	130°	30°	PCD
RD1CR00SW-121R	D4.0*25*SD4*SL57	4.0	25	4	57	130°	30°	PCD
RD1CR00SW-121R	D4.5*30*SD6*SL68	4.5	30	6	68	130°	30°	PCD
RD1CR00SW-121R	D5.0*30*SD6*SL68	5.0	30	6	68	130°	30°	PCD
RD1CR00SW-121R	D5.5*30*SD6*SL68	5.5	30	6	68	130°	30°	PCD
RD1CR00SW-121R	D6.0*30*SD6*SL68	6.0	30	6	68	130°	30°	PCD
RD1CR00SW-121R	D6.5*35*SD8*SL86	6.5	35	8	86	130°	30°	PCD
RD1CR00SW-121R	D7.0*35*SD8*SL86	7.0	35	8	86	130°	30°	PCD
RD1CR00SW-121R	D7.5*35*SD8*SL86	7.5	35	8	86	130°	30°	PCD
RD1CR00SW-121R	D8.0*35*SD8*SL86	8.0	35	8	86	130°	30°	PCD

Customized size

PCD Specialty Tools

Specialty cutters for composite materials

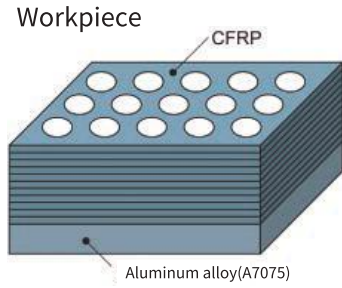
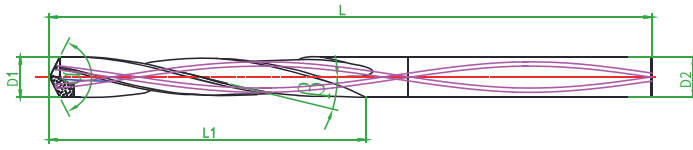

PCD twist drill-- Metric(with internal coolant)

Type	Specification	D1	L1	D2	L	α	β	Material
RD1CRAMSW-121R	D4*25*SD4*SL65	4	25	4	65	130°	15°	PCD
RD1CRAMSW-121R	D5*25*SD6*SL65	5	25	6	65	130°	15°	PCD
RD1CRAMSW-121R	D6*25*SD6*SL65	6	25	6	65	130°	15°	PCD
RD1CRAMSW-121R	D8*35*SD8*SL82	8	35	8	82	130°	15°	PCD
RD1CRAMSW-121R	D10*35*SD10*SL82	10	35	10	82	130°	15°	PCD
RD1CRAMSW-121R	D12*35*SD12*SL82	12	35	12	82	130°	15°	PCD
RD1CRAMSW-121R	D14*45*SD14*SL108	14	45	14	108	130°	15°	PCD
RD1CRAMSW-121R	D16*45*SD16*SL108	16	45	16	108	130°	15°	PCD
RD1CRAMSW-121R	D18*45*SD18*SL108	18	45	18	108	130°	15°	PCD
RD1CRAMSW-121R	D20*50*SD20*SL108	20	50	20	108	130°	15°	PCD

Customized size

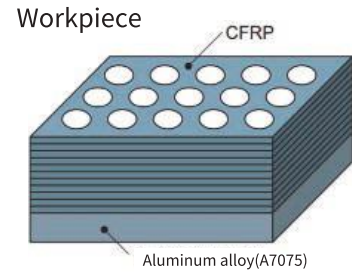
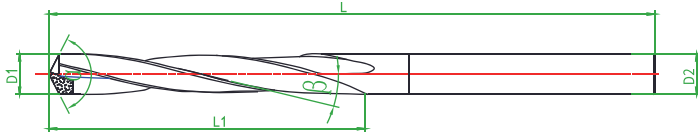

PCD double angle twist drill-- Metric (without internal cold)

Type	Specification	D1	L1	D2	L	α	β	Material
RD1CR00SW-121R	D4*25*SD4*SL65	4	25	4	65	130°	15°	PCD
RD1CR00SW-121R	D5*25*SD6*SL65	5	25	6	65	130°	15°	PCD
RD1CR00SW-121R	D6*25*SD6*SL65	6	25	6	65	130°	15°	PCD
RD1CR00SW-121R	D8*35*SD8*SL82	8	35	8	82	130°	15°	PCD
RD1CR00SW-121R	D10*35*SD10*SL82	10	35	10	82	130°	15°	PCD
RD1CR00SW-121R	D12*35*SD12*SL82	12	35	12	82	130°	15°	PCD
RD1CR00SW-121R	D14*45*SD14*SL108	14	45	14	108	130°	15°	PCD
RD1CR00SW-121R	D16*45*SD16*SL108	16	45	16	108	130°	15°	PCD
RD1CR00SW-121R	D18*45*SD18*SL108	18	45	18	108	130°	15°	PCD
RD1CR00SW-121R	D20*50*SD20*SL108	20	50	20	108	130°	15°	PCD

Customized size

PCD Specialty Tools

Specialty cutters for composite materials

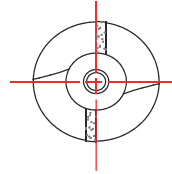
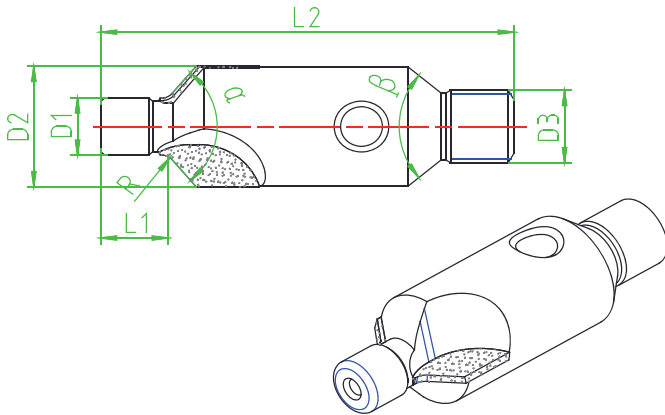

Workpiece



PCD socket drill-- Metric

Type	Specification	D1	L1	D2	α	L2	β	D3	R	Z	Material
RP1TRRSPC-122R	D4.14*7.5*D10-A100*36	4.140	7.5	10	100°	36	120°	1/4--28	0.9	2	PCD
RP1TRRSPC-122R	D4.14*7.5*D10-A130*36	4.140	7.5	10	130°	36	120°	1/4--28	0.6	2	PCD
RP1TRRSPC-122R	D4.8*7.5*D10-A100*36.58	4.800	7.5	10	100°	36.58	120°	1/4--28	0.9	2	PCD
RP1TRRSPC-122R	D4.8*7.5*D10-A130*36.58	4.800	7.5	10	130°	36.58	120°	1/4--28	0.6	2	PCD
RP1TRRSPC-122R	D5.53*7.5*D10-A100*36.58	5.530	7.5	10	100°	36.58	120°	1/4--28	0.9	2	PCD
RP1TRRSPC-122R	D5.53*7.5*D10-A130*36.58	5.530	7.5	10	130°	36.58	120°	1/4--28	0.6	2	PCD
RP1TRRSPC-122R	D6.32*7.5*D14-A100*37.82	6.320	7.5	14	100°	37.82	120°	1/4--28	0.9	2	PCD
RP1TRRSPC-122R	D6.32*7.5*D14-A130*37.82	6.320	7.5	14	130°	37.82	120°	1/4--28	0.6	2	PCD
RP1TRRSPC-122R	D7.91*7.5*D18-A100*39.73	7.910	7.5	18	100°	39.73	120°	1/4--28	1.15	2	PCD
RP1TRRSPC-122R	D7.91*7.5*D18-A130*39.73	7.910	7.5	18	130°	39.73	120°	1/4--28	0.9	2	PCD
RP1TRRSPC-122R	D9.5*8.5*D20-A100*49.5	9.500	8.5	20	100°	49.5	120°	3/4--24	1.15	2	PCD
RP1TRRSPC-122R	D9.5*8.5*D20-A130*49.5	9.500	8.5	20	130°	49.5	120°	3/4--24	0.9	2	PCD
RP1TRRSPC-122R	D11.09*8.5*D23-A100*51	11.090	8.5	23	100°	51	120°	3/4--24	1.4	2	PCD
RP1TRRSPC-122R	D11.09*8.5*D23-A130*51	11.090	8.5	23	130°	51	120°	3/4--24	1.2	2	PCD
RP1TRRSPC-122R	D12.68*8.5*D26-A100*49	12.680	8.5	26	100°	49	120°	3/4--24	1.4	2	PCD
RP1TRRSPC-122R	D12.68*8.5*D26-A130*49	12.680	8.5	26	130°	49	120°	3/4--24	1.2	2	PCD

Customized size

PCD Specialty Tools

Specialty cutters for composite materials

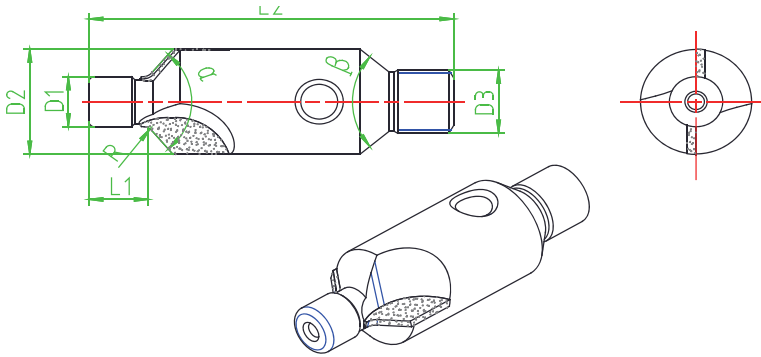

Workpiece



PCD socket drill--Imperial

Type	Specification	D1	L1	D2	α	L2	β	D3	R	Z	Material
RP1TRRSPC-122R	D4.8*7.62*D9.525-A100*25.4	4.800	7.62	9.525	100°	25.4	120°	1/4--28	1	2	PCD
RP1TRRSPC-122R	D6.299*15.24*D13.97-A100*38.1	6.299	15.24	13.970	100°	38.1	120°	1/4--28	1	2	PCD
RP1TRRSPC-122R	D6.578*7.62*D13.97-A130*25.4	6.578	7.62	13.970	130°	25.4	120°	1/4--28	1	2	PCD
RP1TRRSPC-122R	D9.525*7.62*D22.225-A100*38.1	9.525	7.62	22.225	100°	38.1	120°	3/8--24	1	2	PCD
RP1TRRSPC-122R	D9.525*7.62*D22.225-A130*38.1	9.525	7.62	22.225	130°	38.1	120°	3/8--24	1	2	PCD
RP1TRRSPC-122R	D7.925*7.62*D22.225-A130*38.1	7.925	7.62	22.225	130°	38.1	120°	3/8--24	1	2	PCD
RP1TRRSPC-122R	D7.925*7.62*D22.225-A100*38.1	7.925	7.62	22.225	100°	38.1	120°	3/8--24	1	2	PCD

Customized size

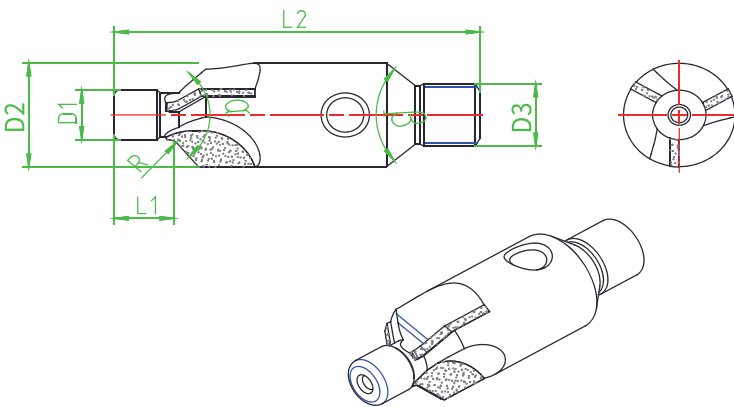

Workpiece



PCD socket drill--Imperial

Type	Specification	D1	L1	D2	α	L2	β	D3	R	Z	Material
RP1TRRSPC-133R	D4.8*7.62*D9.525-A100*25.4	4.800	7.62	9.525	100°	25.4	120°	1/4--28	1	3	PCD
RP1TRRSPC-133R	D6.299*15.24*D13.97-A100*38.1	6.299	15.24	13.970	100°	38.1	120°	1/4--28	1	3	PCD
RP1TRRSPC-133R	D6.578*7.62*D13.97-A130*25.4	6.578	7.62	13.970	130°	25.4	120°	1/4--28	1	3	PCD
RP1TRRSPC-133R	D9.525*7.62*D22.225-A100*38.1	9.525	7.62	22.225	100°	38.1	120°	3/8--24	1	3	PCD
RP1TRRSPC-133R	D9.525*7.62*D22.225-A130*38.1	9.525	7.62	22.225	130°	38.1	120°	3/8--24	1	3	PCD
RP1TRRSPC-133R	D7.925*7.62*D22.225-A130*38.1	7.925	7.62	22.225	130°	38.1	120°	3/8--24	1	3	PCD
RP1TRRSPC-133R	D7.925*7.62*D22.225-A100*38.1	7.925	7.62	22.225	100°	38.1	120°	3/8--24	1	3	PCD

Customized size

PCD Specialty Tools

Specialty cutters for composite materials

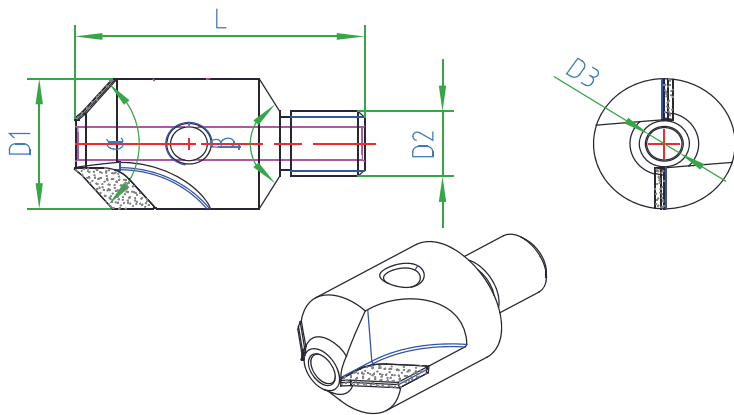

Workpiece



PCD socket drill with pin hole--Imperial

Type	Specification	D1	D3	α	L	D2	β	Z	Material
RP1TR00PC-122R	D10*D2-A100*28	10	2	100°	28	1/4-28 UNF	120°	2	PCD
RP1TR00PC-122R	D10*D2.5-A100*28	10	2.5	100°	28	1/4-28 UNF	120°	2	PCD
RP1TR00PC-122R	D10*D3-A100*28	10	3	100°	28	1/4-28 UNF	120°	2	PCD
RP1TR00PC-122R	D10*D3.5-A100*28	10	3.5	100°	28	1/4-28 UNF	120°	2	PCD
RP1TR00PC-122R	D14*D2.5-A100*28	14	2.5	100°	28	1/4-28 UNF	120°	2	PCD
RP1TR00PC-122R	D14*D3-A100*28	14	3	100°	28	1/4-28 UNF	120°	2	PCD
RP1TR00PC-122R	D14*D3.5-A100*28	14	3.5	100°	28	1/4-28 UNF	120°	2	PCD
RP1TR00PC-122R	D14*D4-A100*28	14	4	100°	28	1/4-28 UNF	120°	2	PCD
RP1TR00PC-122R	D17*D3-A100*28	17	3	100°	28	1/4-28 UNF	120°	2	PCD
RP1TR00PC-122R	D17*D3.5-A100*28	17	3.5	100°	28	1/4-28 UNF	120°	2	PCD
RP1TR00PC-122R	D17*D4-A100*28	17	4	100°	28	1/4-28 UNF	120°	2	PCD
RP1TR00PC-122R	D17*D5-A100*28	17	5	100°	28	1/4-28 UNF	120°	2	PCD
RP1TR00PC-122R	D21*D3.5-A100*28	21	3.5	100°	28	1/4-28 UNF	120°	2	PCD
RP1TR00PC-122R	D21*D4-A100*28	21	4	100°	28	1/4-28 UNF	120°	2	PCD
RP1TR00PC-122R	D21*D5-A100*28	21	5	100°	28	1/4-28 UNF	120°	2	PCD
RP1TR00PC-122R	D22.225*D6-A100*28	22.225	6	100°	28	1/4-28 UNF	120°	2	PCD
RP1TR00PC-122R	D25.4*D6-A100*28	25.4	6	100°	28	1/4-28 UNF	120°	2	PCD
RP1TR00PC-122R	D28.575*D6-A100*28	28.575	6	100°	28	1/4-28 UNF	120°	2	PCD
RP1TR00PC-122R	D31.75*D6-A100*28	31.75	6	100°	28	1/4-28 UNF	120°	2	PCD
RP1TR00PC-122R	D34.925*D6-A100*28	34.925	6	100°	28	1/4-28 UNF	120°	2	PCD
RP1TR00PC-122R	D38.1*D6-A100*28	38.1	6	100°	28	1/4-28 UNF	120°	2	PCD

Customized size

PCD Specialty Tools

Specialty cutters for composite materials

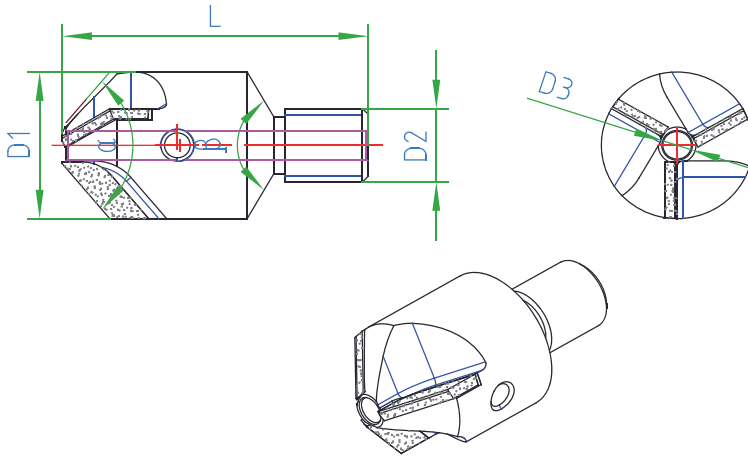

Workpiece



PCD socket drill with pin hole--Imperial

Type	Specification	D1	D3	α	L	D2	β	Z	Material
RP1TR00PC-133R	D10*D2-A100*28	10	2	100°	28	1/4-28 UNF	120°	3	PCD
RP1TR00PC-133R	D10*D2.5-A100*28	10	2.5	100°	28	1/4-28 UNF	120°	3	PCD
RP1TR00PC-133R	D10*D3-A100*28	10	3	100°	28	1/4-28 UNF	120°	3	PCD
RP1TR00PC-133R	D10*D3.5-A100*28	10	3.5	100°	28	1/4-28 UNF	120°	3	PCD
RP1TR00PC-133R	D14*D2.5-A100*28	14	2.5	100°	28	1/4-28 UNF	120°	3	PCD
RP1TR00PC-133R	D14*D3-A100*28	14	3	100°	28	1/4-28 UNF	120°	3	PCD
RP1TR00PC-133R	D14*D3.5-A100*28	14	3.5	100°	28	1/4-28 UNF	120°	3	PCD
RP1TR00PC-133R	D14*D4-A100*28	14	4	100°	28	1/4-28 UNF	120°	3	PCD
RP1TR00PC-133R	D17*D3-A100*28	17	3	100°	28	1/4-28 UNF	120°	3	PCD
RP1TR00PC-133R	D17*D3.5-A100*28	17	3.5	100°	28	1/4-28 UNF	120°	3	PCD
RP1TR00PC-133R	D17*D4-A100*28	17	4	100°	28	1/4-28 UNF	120°	3	PCD
RP1TR00PC-133R	D17*D5-A100*28	17	5	100°	28	1/4-28 UNF	120°	3	PCD
RP1TR00PC-133R	D21*D3.5-A100*28	21	3.5	100°	28	1/4-28 UNF	120°	3	PCD
RP1TR00PC-133R	D21*D4-A100*28	21	4	100°	28	1/4-28 UNF	120°	3	PCD
RP1TR00PC-133R	D21*D5-A100*28	21	5	100°	28	1/4-28 UNF	120°	3	PCD
RP1TR00PC-133R	D22.225*D6-A100*28	22.225	6	100°	28	1/4-28 UNF	120°	3	PCD
RP1TR00PC-133R	D25.4*D6-A100*28	25.4	6	100°	28	1/4-28 UNF	120°	3	PCD
RP1TR00PC-133R	D28.575*D6-A100*28	28.575	6	100°	28	1/4-28 UNF	120°	3	PCD
RP1TR00PC-133R	D31.75*D6-A100*28	31.75	6	100°	28	1/4-28 UNF	120°	3	PCD
RP1TR00PC-133R	D34.925*D6-A100*28	34.925	6	100°	28	1/4-28 UNF	120°	3	PCD
RP1TR00PC-133R	D38.1*D6-A100*28	38.1	6	100°	28	1/4-28 UNF	120°	3	PCD

Customized size

PCD Specialty Tools

Specialty cutters for composite materials

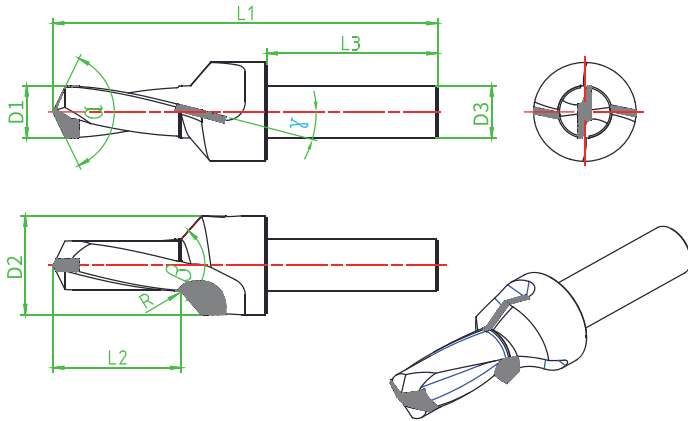

Workpiece

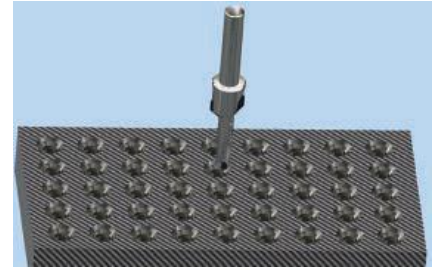

PCD twist drill countersink -- Metric(US/Imperial standard, refer to Conversion Table at Page 45)

Type	Specification	D1	L2	D2	D3	L1	α	β	γ	L3	Z	Material
RD1CR00SW-122R	D4*30*D10*SD8*SL90	4	30	10	8	90	120°	100°	15°	40	2	PCD
RD1CR00SW-122R	D5*30*D12*SD10*SL90	5	30	12	10	90	120°	100°	15°	40	2	PCD
RD1CR00SW-122R	D6*30*D14*SD12*SL90	6	30	14	12	90	120°	100°	15°	40	2	PCD
RD1CR00SW-122R	D8*30*D18*SD16*SL90	8	30	18	16	90	120°	100°	15°	40	2	PCD
RD1CR00SW-122R	D10*30*D20*SD18*SL90	10	30	20	18	90	120°	100°	15°	40	2	PCD
RD1CR00SW-122R	D12*30*D22*SD20*SL90	12	30	22	20	90	120°	100°	15°	40	2	PCD

Customized size

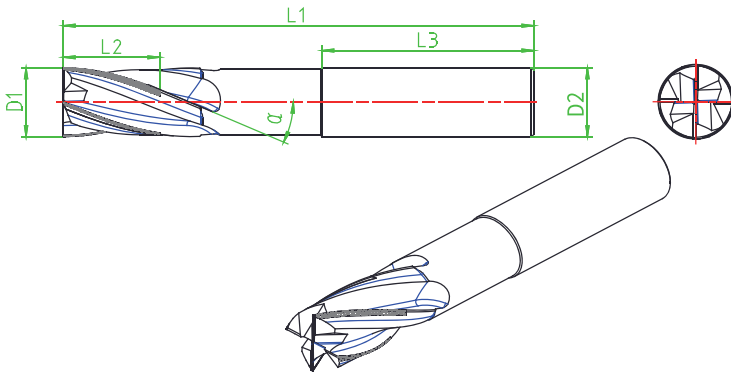

Workpiece



PCD spiral milling cutter -- Metric(US/Imperial standard, refer to Conversion Table at Page 45)

Type	Specification	D1	L2	D2	L1	L4	α	Z	Material
RE1CR00SW-144R	D6*20*SD6*SL80	6	20	6	80	45	15°/30°	4	PCD
RE1CR00SW-144R	D8*20*SD8*SL80	8	20	8	80	45	15°/30°	4	PCD
RE1CR00SW-144R	D10*20*SD10*SL80	10	20	10	80	45	15°/30°	4	PCD
RE1CR00SW-144R	D12*20*SD12*SL100	12	20	12	100	45	15°/30°	4	PCD
RE1CR00SW-144R	D14*20*SD16*SL100	14	20	16	100	45	15°/30°	4	PCD
RE1CR00SW-144R	D16*20*SD16*SL100	16	20	16	100	45	15°/30°	4	PCD
RE1CR00SW-144R	D20*25*SD20*SL110	20	25	20	110	50	15°/30°	4	PCD

Customized size

PCD Specialty Tools

Specialty cutters for composite materials

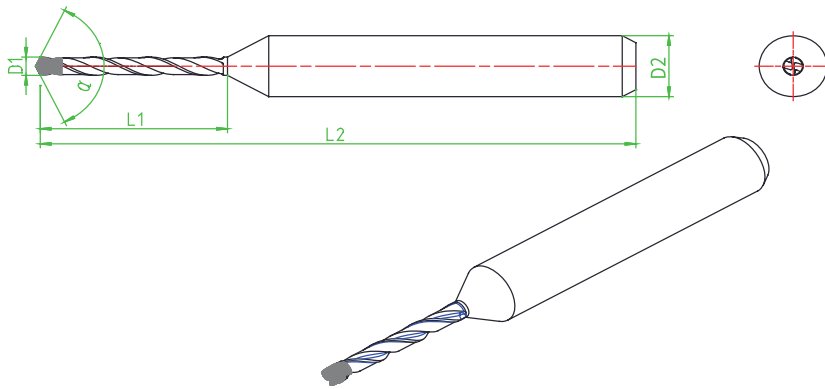

Workpiece

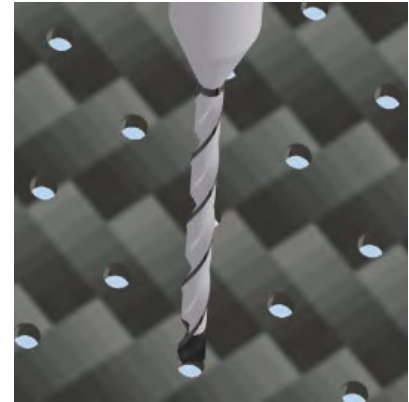

PCD ultra-small drill--Imperial

Type	Specification	D1	L1	D2	L2	α	Material
RD1CR00SW-122R	D0.40*8*SD3.175*SL38	0.40	8	3.175	38	130°	PCD
RD1CR00SW-122R	D0.45*8*SD3.175*SL38	0.45	8	3.175	38	130°	PCD
RD1CR00SW-122R	D0.50*8*SD3.175*SL38	0.50	8	3.175	38	130°	PCD
RD1CR00SW-122R	D0.55*8*SD3.175*SL38	0.55	8	3.175	38	130°	PCD
RD1CR00SW-122R	D0.60*8*SD3.175*SL38	0.60	8	3.175	38	130°	PCD
RD1CR00SW-122R	D0.65*8*SD3.175*SL38	0.65	8	3.175	38	130°	PCD
RD1CR00SW-122R	D0.70*8*SD3.175*SL38	0.70	8	3.175	38	130°	PCD
RD1CR00SW-122R	D0.75*8*SD3.175*SL38	0.75	8	3.175	38	130°	PCD
RD1CR00SW-122R	D0.80*8*SD3.175*SL38	0.80	8	3.175	38	130°	PCD
RD1CR00SW-122R	D0.85*8*SD3.175*SL38	0.85	8	3.175	38	130°	PCD
RD1CR00SW-122R	D0.90*8*SD3.175*SL38	0.90	8	3.175	38	130°	PCD
RD1CR00SW-122R	D0.95*8*SD3.175*SL38	0.95	8	3.175	38	130°	PCD
RD1CR00SW-122R	D1.0*8*SD3.175*SL38	1.00	8	3.175	38	130°	PCD
RD1CR00SW-122R	D1.1*11*SD3.175*SL38	1.10	11	3.175	38	130°	PCD
RD1CR00SW-122R	D1.2*11*SD3.175*SL38	1.20	11	3.175	38	130°	PCD
RD1CR00SW-122R	D1.3*11*SD3.175*SL38	1.30	11	3.175	38	130°	PCD
RD1CR00SW-122R	D1.4*11*SD3.175*SL38	1.40	11	3.175	38	130°	PCD
RD1CR00SW-122R	D1.5*11*SD3.175*SL38	1.50	11	3.175	38	130°	PCD
RD1CR00SW-122R	D1.6*11*SD3.175*SL38	1.60	11	3.175	38	130°	PCD
RD1CR00SW-122R	D1.7*11*SD3.175*SL38	1.70	11	3.175	38	130°	PCD
RD1CR00SW-122R	D1.8*11*SD3.175*SL38	1.80	11	3.175	38	130°	PCD
RD1CR00SW-122R	D1.9*11*SD3.175*SL38	1.90	11	3.175	38	130°	PCD
RD1CR00SW-122R	D2.0*11*SD3.175*SL38	2.00	11	3.175	38	130°	PCD
RD1CR00SW-122R	D2.1*11*SD3.175*SL38	2.10	11	3.175	38	130°	PCD
RD1CR00SW-122R	D2.2*11*SD3.176*SL38	2.20	11	3.175	38	130°	PCD
RD1CR00SW-122R	D2.3*11*SD3.175*SL38	2.30	11	3.175	38	130°	PCD
RD1CR00SW-122R	D2.4*11*SD3.175*SL38	2.40	11	3.175	38	130°	PCD
RD1CR00SW-122R	D2.5*11*SD3.175*SL38	2.50	11	3.175	38	130°	PCD

Customized size

PCD Specialty Tools

Specialty cutters for composite materials

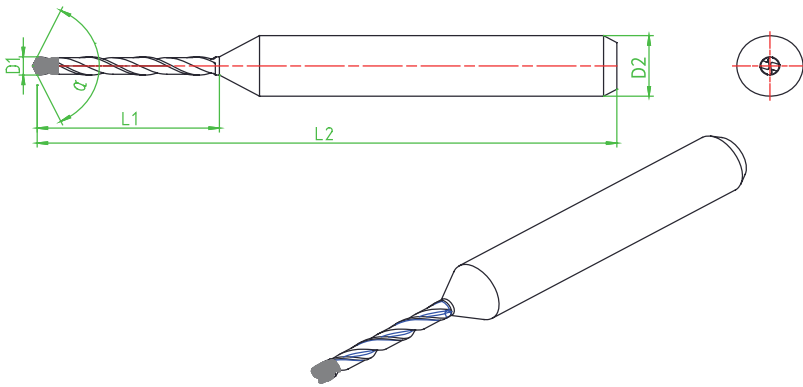

Workpiece

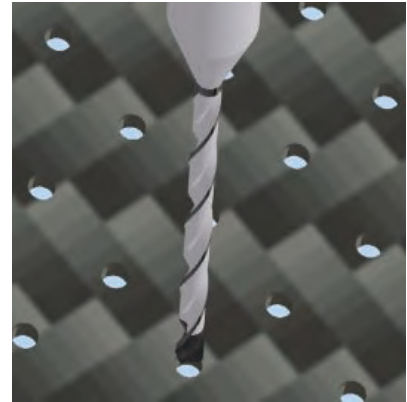

PCD ultra-small drill--Metric(US/Imperial standard, refer to Conversion Table at Page 45)

Type	Specification	D1	L1	D2	L2	α	Material
RD1CR00SW-122R	D0.40*8*SD4*SL38	0.40	8	4	38	130°	PCD
RD1CR00SW-122R	D0.45*8*SD4*SL38	0.45	8	4	38	130°	PCD
RD1CR00SW-122R	D0.50*8*SD4*SL38	0.50	8	4	38	130°	PCD
RD1CR00SW-122R	D0.55*8*SD4*SL38	0.55	8	4	38	130°	PCD
RD1CR00SW-122R	D0.60*8*SD4*SL38	0.60	8	4	38	130°	PCD
RD1CR00SW-122R	D0.65*8*SD4*SL38	0.65	8	4	38	130°	PCD
RD1CR00SW-122R	D0.70*8*SD4*SL38	0.70	8	4	38	130°	PCD
RD1CR00SW-122R	D0.75*8*SD4*SL38	0.75	8	4	38	130°	PCD
RD1CR00SW-122R	D0.80*8*SD4*SL38	0.80	8	4	38	130°	PCD
RD1CR00SW-122R	D0.85*8*SD4*SL38	0.85	8	4	38	130°	PCD
RD1CR00SW-122R	D0.90*8*SD4*SL38	0.90	8	4	38	130°	PCD
RD1CR00SW-122R	D0.95*8*SD4*SL38	0.95	8	4	38	130°	PCD
RD1CR00SW-122R	D1.0*8*SD4*SL38	1.00	8	4	38	130°	PCD
RD1CR00SW-122R	D1.1*11*SD4*SL38	1.10	11	4	38	130°	PCD
RD1CR00SW-122R	D1.2*11*SD4*SL38	1.20	11	4	38	130°	PCD
RD1CR00SW-122R	D1.3*11*SD4*SL38	1.30	11	4	38	130°	PCD
RD1CR00SW-122R	D1.4*11*SD4*SL38	1.40	11	4	38	130°	PCD
RD1CR00SW-122R	D1.5*11*SD4*SL38	1.50	11	4	38	130°	PCD
RD1CR00SW-122R	D1.6*11*SD4*SL38	1.60	11	4	38	130°	PCD
RD1CR00SW-122R	D1.7*11*SD4*SL38	1.70	11	4	38	130°	PCD
RD1CR00SW-122R	D1.8*11*SD4*SL38	1.80	11	4	38	130°	PCD
RD1CR00SW-122R	D1.9*11*SD4*SL38	1.90	11	4	38	130°	PCD
RD1CR00SW-122R	D2.0*11*SD4*SL38	2.00	11	4	38	130°	PCD
RD1CR00SW-122R	D2.1*11*SD4*SL38	2.10	11	4	38	130°	PCD
RD1CR00SW-122R	D2.2*11*SD4*SL38	2.20	11	4	38	130°	PCD
RD1CR00SW-122R	D2.3*11*SD4*SL38	2.30	11	4	38	130°	PCD
RD1CR00SW-122R	D2.4*11*SD4*SL38	2.40	11	4	38	130°	PCD
RD1CR00SW-122R	D2.5*11*SD4*SL38	2.50	11	4	38	130°	PCD

Customized size

PCD Specialty Tools

Specialty cutters for composite materials

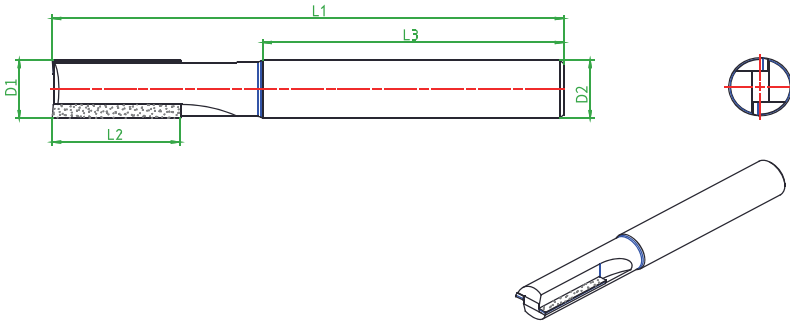

Workpiece

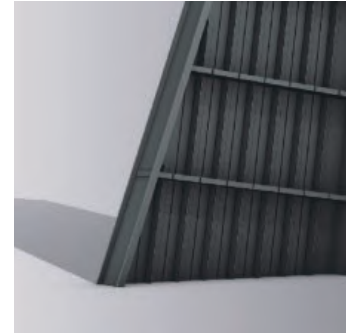

PCD milling cutter(not over center)--Imperial

Type	Specification	D1	L2	D2	L1	L3	Z	Material
RE1CR0000-122R	D4.76*6.35*SD4.76*SL52	4.760	6.35	4.760	52	35	2	PCD
RE1CR0000-122R	D6.35*12.7*SD6.35*SL63.5	6.350	12.7	6.350	63.5	37	2	PCD
RE1CR0000-122R	D9.525*19.05*SD9.525*SL101.6	9.525	19.05	9.525	101.6	61	2	PCD
RE1CR0000-122R	D12.7*25.4*SD12.7*SL102	12.700	25.4	12.700	102	61	2	PCD
RE1CR0000-122R	D19.05*25.4*SD19.05*SL102	19.050	25.4	19.050	102	61	2	PCD

Customized size

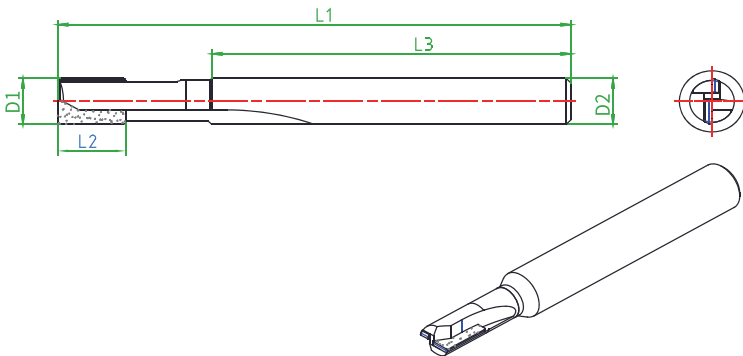

Workpiece

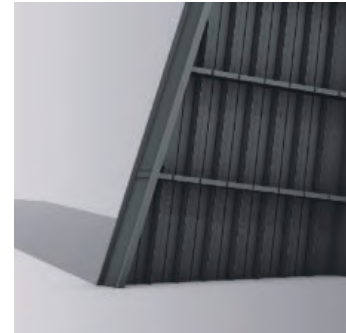

PCD milling cutter(over center)--Imperial

Type	Specification	D1	L2	D2	L1	L3	Z	Material
RE1CR00CC-122R	D4.76*6.35*SD4.76*SL52	4.760	6.35	4.760	52	35	2	PCD
RE1CR00CC-122R	D6.35*12.7*SD6.35*SL63.5	6.350	12.7	6.350	63.5	37	2	PCD
RE1CR00CC-122R	D9.525*19.05*SD9.525*SL101.6	9.525	19.05	9.525	101.6	61	2	PCD
RE1CR00CC-122R	D12.7*25.4*SD12.7*SL102	12.700	25.4	12.700	102	61	2	PCD
RE1CR00CC-122R	D19.05*25.4*SD19.05*SL102	19.050	25.4	19.050	102	61	2	PCD

Customized size

PCD Specialty Tools

Specialty cutters for composite materials

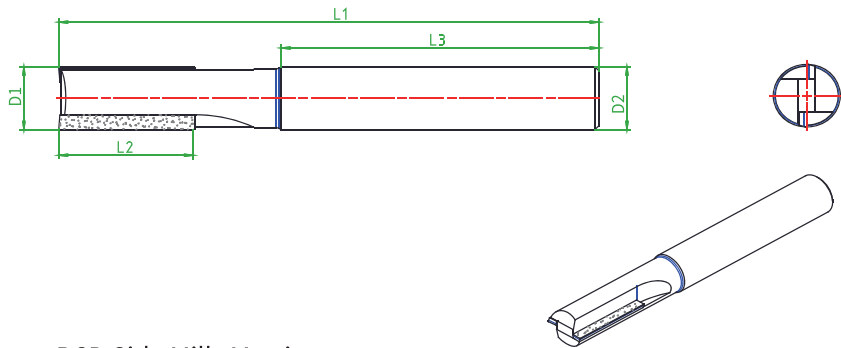

Workpiece

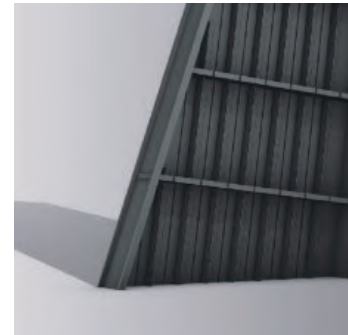

PCD Side Mill--Metric

Type	Specification	D1	L2	D2	L1	L3	Z	Material
RE1CR0000-122R	D6*9*SD6*SL50	6	9	6	50	30	2	PCD
RE1CR0000-122R	D8*12*SD8*SL60	8	12	8	60	30	2	PCD
RE1CR0000-122R	D10*15*SD10*SL80	10	15	10	80	45	2	PCD
RE1CR0000-122R	D12*18*SD12*SL100	12	18	12	100	45	2	PCD
RE1CR0000-122R	D16*25*SD16*SL110	16	25	16	110	55	2	PCD

Customized size

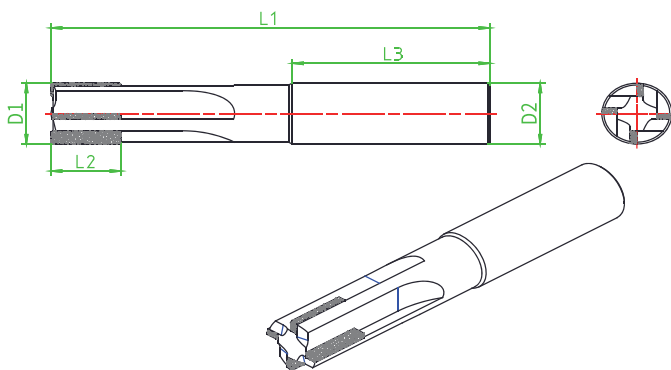

Workpiece

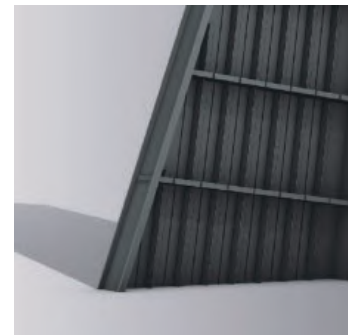

PCD Side Mill--Metric

Type	Specification	D1	L2	D2	L1	L3	Z	Material
RE1CR0000-144R	D10*15*SD10*SL80	10	15	10	80	45	4	PCD
RE1CR0000-144R	D12*18*SD12*SL100	12	18	12	100	45	4	PCD
RE1CR0000-144R	D16*25*SD16*SL110	16	25	16	110	55	4	PCD
RE1CR0000-144R	D18*25*SD18*SL110	18	25	18	110	55	4	PCD
RE1CR0000-144R	D20*30*SD20*SL110	20	30	20	110	55	4	PCD

Customized size

PCD Specialty Tools

Specialty cutters for composite materials

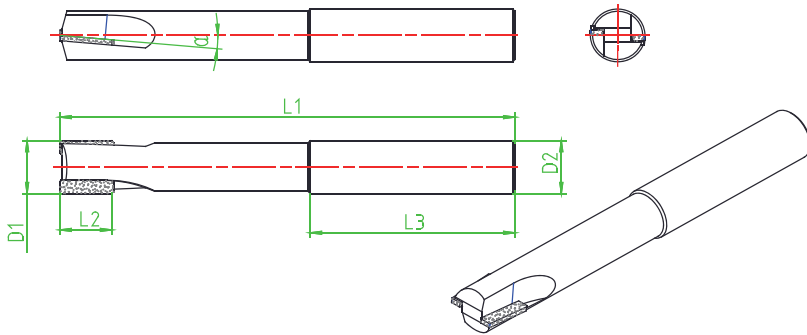

Workpiece

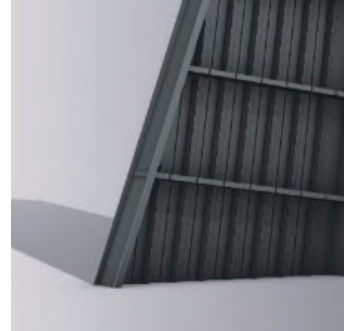

PCD Side Mill--Imperial

Type	Specification	D1	L2	D2	L1	L3	Z	α	Material
RE1CR0000-122R	D4.76*6.35*SD4.76*SL52	4.760	6.35	4.760	52	35	2	5°	PCD
RE1CR0000-122R	D6.35*12.7*SD6.35*SL63.5	6.350	12.7	6.350	63.5	37	2	5°	PCD
RE1CR0000-122R	D9.525*19.05*SD9.525*SL101.6	9.525	19.05	9.525	101.6	61	2	5°	PCD
RE1CR0000-122R	D12.7*25.4*SD12.7*SL102	12.700	25.4	12.700	102	61	2	5°	PCD
RE1CR0000-122R	D19.05*25.4*SD19.05*SL102	19.050	25.4	19.050	102	61	2	5°	PCD

Customized size

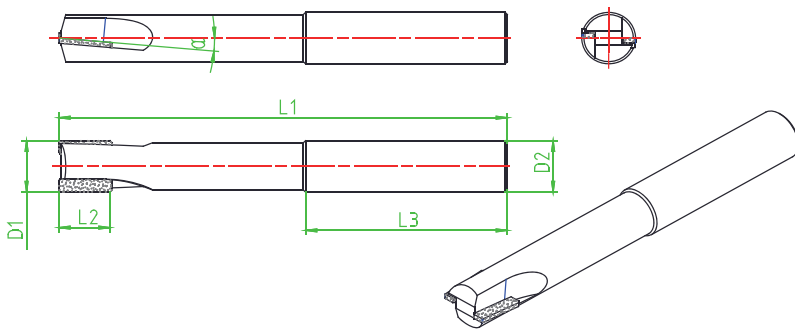

Workpiece

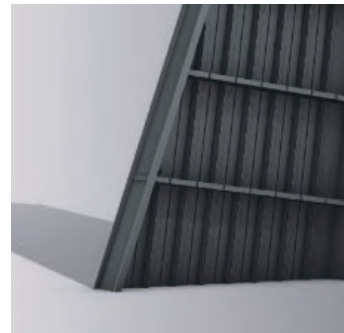

PCD Side Mill--Metric

Type	Specification	D1	L2	D2	L1	L3	Z	α	Material
RE1CR0000-122R	D6*9*SD6*SL50	6	9	6	50	30	2	5°	PCD
RE1CR0000-122R	D8*12*SD8*SL60	8	12	8	60	30	2	5°	PCD
RE1CR0000-122R	D10*15*SD10*SL80	10	15	10	80	45	2	5°	PCD
RE1CR0000-122R	D12*18*SD12*SL100	12	18	12	100	45	2	5°	PCD
RE1CR0000-122R	D16*25*SD16*SL110	16	25	16	110	55	2	5°	PCD

Customized size

PCD Specialty Tools

Specialty cutters for composite materials

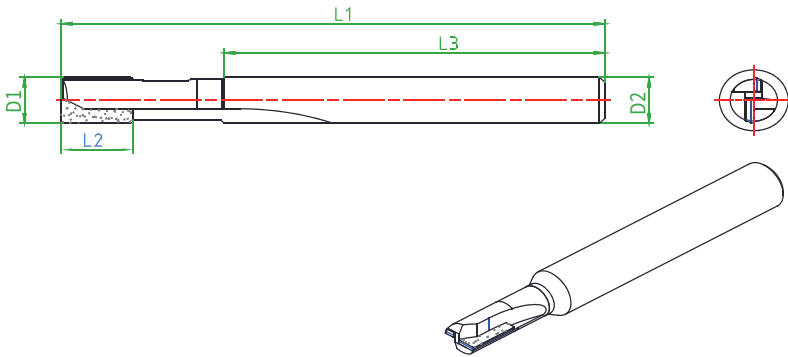

Workpiece

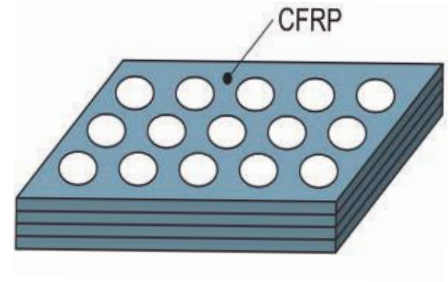

PCD End Mill--Metric

Type	Specification	D1	L2	D2	L1	L3	Z	Material
RE1CR00CC-122R	D6*9*SD6*SL50	6	9	6	50	30	2	PCD
RE1CR00CC-122R	D8*12*SD8*SL60	8	12	8	60	30	2	PCD
RE1CR00CC-122R	D10*15*SD10*SL80	10	15	10	80	45	2	PCD
RE1CR00CC-122R	D12*18*SD12*SL100	12	18	12	100	45	2	PCD
RE1CR00CC-122R	D16*25*SD16*SL110	16	25	16	110	55	2	PCD

Customized size

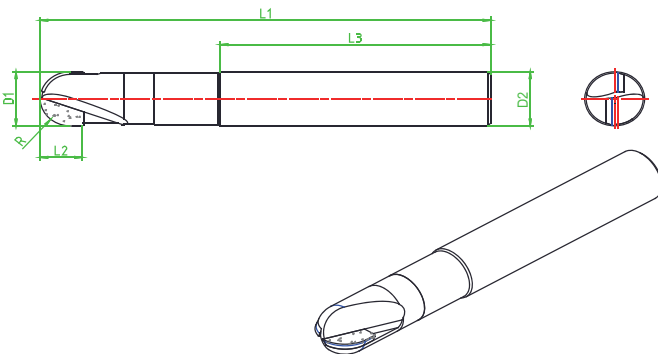

Workpiece



PCD ball nose mill-- Metric

Type	Specification	D1	L2	D2	L1	R	L3	Z	Material
RE1CR00CC-122R	D4*6*SD4*SL45	4	6	4	45	2	35	2	PCD
RE1CR00CC-122R	D6*9*SD6*SL50	6	9	6	50	3	35	2	PCD
RE1CR00CC-122R	D8*12*SD8*SL60	8	12	8	60	4	35	2	PCD
RE1CR00CC-122R	D10*15*SD10*SL70	10	15	10	70	5	40	2	PCD
RE1CR00CC-122R	D12*18*SD12*SL80	12	18	12	80	6	45	2	PCD

Customized size

PCD Specialty Tools

Specialty cutters for composite materials

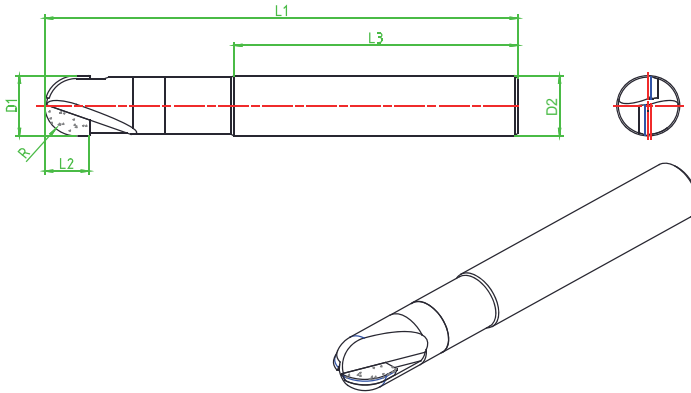

Workpiece



PCD ball nose mill--Imperial

Type	Specification	D1	L2	D2	L1	R	L3	Z	Material
RE1CR00CC-122R	D4.76*6.35*SD4.76*SL50	4.760	6.35	4.76	50	2.38	30	2	PCD
RE1CR00CC-122R	D6.35*9.525*SD6.35*SL60	6.350	9.525	6.35	60	3.18	35	2	PCD
RE1CR00CC-122R	D9.525*12.7*SD9.525*SL70	9.525	12.7	9.525	70	4.76	40	2	PCD
RE1CR00CC-122R	D12.7*14.7*SD12.7*SL80	12.700	14.7	12.7	80	6.35	45	2	PCD
RE1CR00CC-122R	D19.05*20.4*SD19.05*SL90	19.050	20.4	19.05	90	9.53	45	2	PCD

Customized size

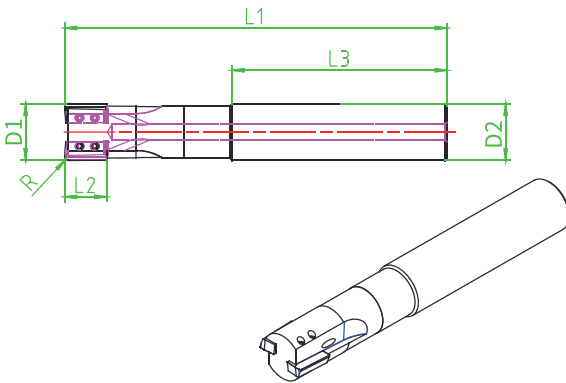

PCD quick change milling cutter-- Metric

Type	Specification	D1	L2	D2	L1	L3	R	α	Z	Material
RR1CR00SW-122R	D12*8*SD12*SL80	12	8	12	80	45	0.4	3°	2	PCD
RR1CR00SW-122R	D14*10*SD16*SL90	14	10	16	90	45	0.4	3°	2	PCD
RR1CR00SW-122R	D16*10*SD16*SL100	16	10	16	100	45	0.4	3°	2	PCD
RR1CR00SW-122R	D18*12*SD20*SL120	18	12	20	120	45	0.4	3°	2	PCD
RR1CR00SW-122R	D20*12*SD20*SL120	20	12	20	120	45	0.4	3°	2	PCD
RR1CR00SW-122R	D25*12*SD25*SL150	25	12	25	150	45	0.4	3°	2	PCD
RR1CR00SW-122R	D32*12*SD32*SL150	32	12	32	150	45	0.4	3°	2	PCD

Customized size

PCD Specialty Tools

Specialty cutters for composite materials

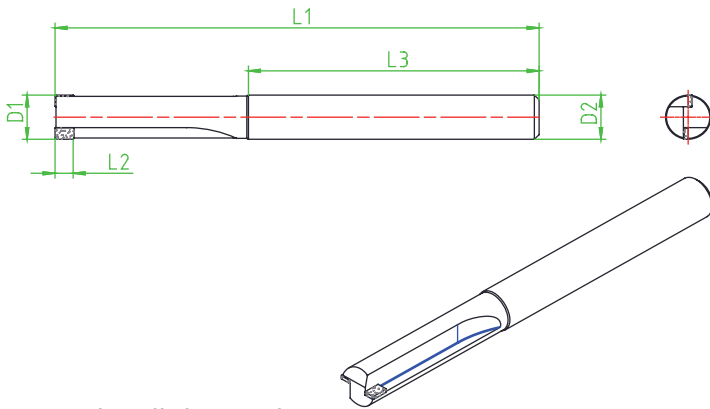

CVD Side Mill--Imperial

Type	Specification	D1	L2	D2	L1	L3	Z	Material
RE1CR0000-122R	D4.76*4.76*SD4.76*SL52	4.7604	4.76	.760	52	35	2	CVDD
RE1CR0000-122R	D6.35*6.35*SD6.35*SL635	6.3506	6.35	.350	63.5	37	2	CVDD
RE1CR0000-122R	D9.525*6.35*SD9.525*SL1016	9.5259	6.35	.525	101.66	1	2	CVDD
RE1CR0000-122R	D12.7*6.35*SD12.7*SL102	12.7001	6.35	2.700	102	60	2	CVDD
RE1CR0000-122R	D15.875*6.35*SD19.05*SL102	15.875	6.35	19.050	102	61	2	CVDD

Customized size

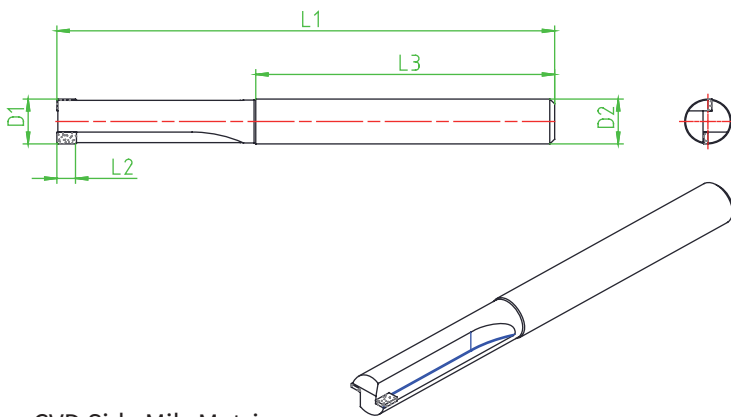

CVD Side Mill--Metric

Type	Specification	D1	L2	D2	L1	L3	Z	Material
RE1CR0000-122R	D6*4*SD6*SL50	6	46		50	30	2	CVDD
RE1CR0000-122R	D8*6*SD8*SL60	8	68		60	30	2	CVDD
RE1CR0000-122R	D10*6*SD10*SL80	10	61	08	04	5	2	CVDD
RE1CR0000-122R	D12*6*SD12*SL100	12	61	2	100	45	2	CVDD
RE1CR0000-122R	D16*6*SD16*SL110	16	61	6	110	55	2	CVDD

Customized size



Worldia® Specialty Tools Business Scope

1. Design and produce PCD/PCBN reamer, milling cutter and specialty tools products according to customer drawings;
2. According to customer requirements, undertake the design, production and technical service of the entire set of tools programs;
3. Replace the original cutters to help customers optimize the existing cutter program to meet the needs of improving life and reducing costs;
4. Regrinding and retipping for PCD/PCBN specialty tools

Worldia® After-sales Service and Customer Service

Pre-sale service

Provide pre-sale services including conduct technical investigations on the customer's processing conditions like workpiece materials, tooling fixtures, production cycle, machine tool parameters, and provide feasibility solutions for the optimization and upgrade of the original products;

After-sales service

Provide after-sale technical services and technical following-up for product performance, meet customer processing requirements with higher dimensional accuracy, better processing performance, longer service life, and faster production cycle.

Metric and Imperial Conversion Table

Metric and Imperial Conversion Table

in (")	Metric unit:mm		Imperial unit:mm				
	mm	in (")	mm	in (")	mm	in (")	mm
1/64	0.3969	17/64	6.7469	33/64	13.0969	49/64	19.446 9
1/32	0.7938	9/32	7.1438	17/32	13.4938	25/32	19.843 8
3/64	1.1906	19/64	7.5406	35/64	13.8906	51/64	20.240 6
1/16	1.5875	5/16	7.9375	9/16	14.2875	13/16	20.637 5
5/64	1.9844	21/64	8.3344	37/64	14.6844	53/64	21.034 4
3/32	2.3813	11/32	8.7313	19/32	15.0813	27/32	21.431 3
7/64	2.7781	23/64	9.1281	39/64	15.4781	55/64	21.828 1
1/8	3.175 03	/8	9.5250	5/8	15.8750	7/8	22.225 0
9/64	3.5719	25/64	9.9219	41/64	16.2719	57/64	22.621 9
5/32	3.9688	13/64	10.3188	21/32	16.6688	29/32	23.018 8
11/64	4.3656	27/64	10.7156	43/64	17.0656	59/64	23.415 6
3/16	4.7625	7/16	11.1125	11/16	17.4625	15/16	23.812 5
13/64	5.1594	29/64	11.5094	45/64	17.8594	61/64	24.209 4
7/32	5.5563	15/32	11.9063	23/32	18.2563	31/32	24.606 3
15/64	5.9531	31/64	12.3031	47/64	18.6531	63/64	25.003 1
1/4	6.350 01	/2	12.7000	3/4	19.050 01		25.400 0

More Information View [Http://www.worldiatools.com](http://www.worldiatools.com)



PCD Insert

Non-ferrous metal and non-metal processing

PCBN Insert

Hardened steel, cast iron, powder metallurgy processing

PCD, PCBN Grooving Solution

End face groove, External circular groove, Thread processing

PCD Face Milling Cutter

PCD Non-standard Tools



WORLDIA

BEIJING WORLDIA DIAMOND TOOLS CO., LTD.

Tel.: +86 10-58411388 ext. 8082

Email: info@worldia-tools.com

Office Address: Room H-03, 5F, M7 Building, No.1 Jiuxianqiao
East Road, Chaoyang District Beijing, China 100015

